

5.0x7.0mm LVCMOS 3.3V VCXO

CONNOR WINFIELD



2111 Comprehensive Drive

Aurora, Illinois 60505

Phone: 630-851-4722

Fax: 630-851-5040

www.conwin.com

US Headquarters

630-851-4722:

European Headquarters:

+353-61-472221

Description

The Connor Winfield, RoHS compliant model V802 is a 3.3V, Surface Mount 5.0x7.0mm, Voltage Controlled Crystal Oscillator (VCXO) with a LVCMOS output and enable/ disable function. The V802 is designed for use with applications utilizing a PLL system requiring low jitter and tight frequency stability. The surface mount package is designed for high-density mounting and is optimum for mass production.



Features

Models: V802

65 to 130 MHz
3.3V Operation
Absolute Pull Range (APR): +/-50ppm
Temperature Range: 0 to 70°C
LVCMOS Output
Low Jitter 0.4ps RMS Typical
Enable / Disable Function:
5.0x7.0mm Surface Mount Package
Tape and Reel Packaging
RoHS Compliant / Lead Free ✓RoHS

Specifications

ABSOLUTE MAXIMUM RATINGS

TABLE 1.0

PARAMETER	UNITS	MINIMUM	NOMINAL	MAXIMUM	UNITS	NOTE
Storage Temperature		-55	-	125	°C	
Supply Voltage	(Vcc)	-0.5	-	4.6	Vdc	
Control Voltage	(Vc)	-0.5	-	Vcc+0.5	Vdc	

OPERATING SPECIFICATIONS

TABLE 2.0

PARAMETER		MINIMUM	NOMINAL	MAXIMUM	UNITS	NOTE
Center Frequency	(Fo)	65	-	130	MHz	
Operating Temperature Range		0	-	70	°C	
Supply Voltage	(Vcc)	3.135	3.3	3.465	Vdc	
Supply Current	(Icc)	-	-	40	mA	
Period Jitter		-	3.0	5.0	ps rms	
Integrated Phase Jitter (BW=12kHz to 20MHz)		-	0.5	1	ps rms	
Typical Phase Noise Fo = 74.25 MHz						
SSB Phase Noise at 10Hz offset		-	-55	-	dBc/Hz	
SSB Phase Noise at 100Hz offset		-	-85	-	dBc/Hz	
SSB Phase Noise at 1KHz offset		-	-115	-	dBc/Hz	
SSB Phase Noise at 10KHz offset		-	-135	-	dBc/Hz	
SSB Phase Noise at 100KHz offset		-	-150	-	dBc/Hz	

INPUT CHARACTERISTICS

TABLE 3.0

PARAMETER		MINIMUM	NOMINAL	MAXIMUM	UNITS	NOTE
Control Voltage Range	(Vc)	0.3	1.65	3.0	Vdc	
Absolute Pull Range (APR)		±50	-	-	ppm	1
Monotonic Linearity		-10	-	10	%	
DC Input Resistance		-	60K	-	Ohm	2
Modulation Bandwidth (3dB)		10	-	-	KHz	
Enable Input Voltage (High)	(Vih)	2.4	-	-	Vdc	3
Disable Input Voltage (Low)	(Vil)	-	-	0.4	Vdc	3

LVCMOS OUTPUT CHARACTERISTICS

TABLE 4.0

PARAMETER		MINIMUM	NOMINAL	MAXIMUM	UNITS	NOTE
LOAD		-	-	15	pF	
Voltage (High)	(Voh)	2.4	-	-	Vdc	
(Low)	(Vol)	-	-	0.4	Vdc	
Duty Cycle at 50% Level		45	50	55	%	
Rise / Fall Time 20% to 80%		-	-	2	nS	

PACKAGE CHARACTERISTICS

TABLE 5.0

Package	Hermetically sealed ceramic package with grounded metal cover
---------	---

PROCESS RECOMMENDATIONS

TABLE 6.0

Soldering Process	RoHS compliant, lead free. See solder profile page 2.
-------------------	---



Bulletin Vx514

Page 1 of 2

Revision 03

Date 05 Dec 2007

Notes

- 1.0 Absolute pull range (APR) is the minimum guaranteed pull range of the VCXO under all conditions over the lifetime operation. Including calibration @ 25°C, frequency vs. change in temperature, frequency vs. change in supply voltage, frequency vs. change in load, shock and vibration and aging for ten years. The APR is referenced to Fo. Positive Transfer Function.
- 2.0 Measured from pin 1 to ground.
- 3.0 Outputs are enabled with no connection on pad 2.

Output Waveform

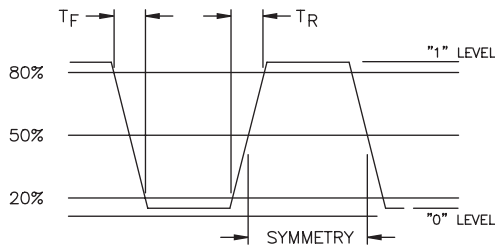

Package Layout

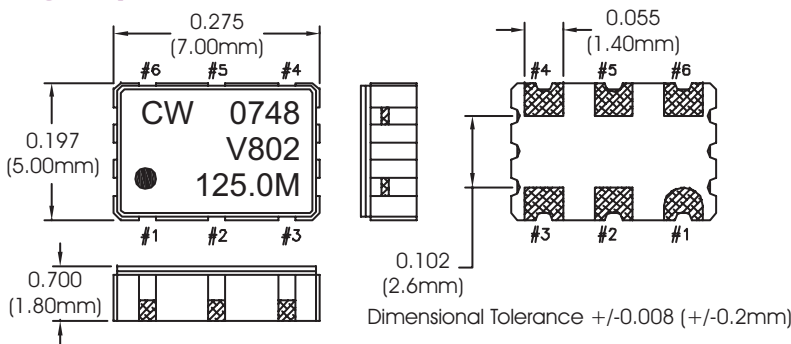

Test Circuit

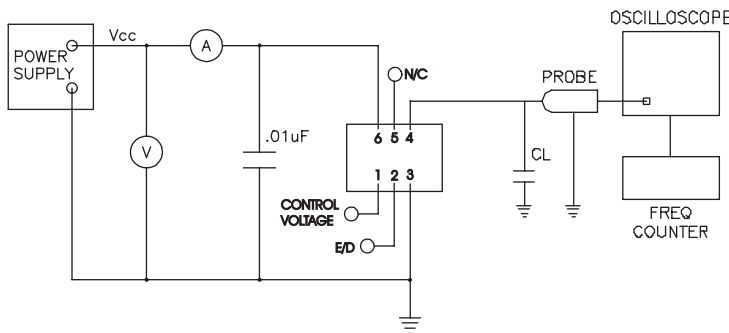

Tape and Reel Information

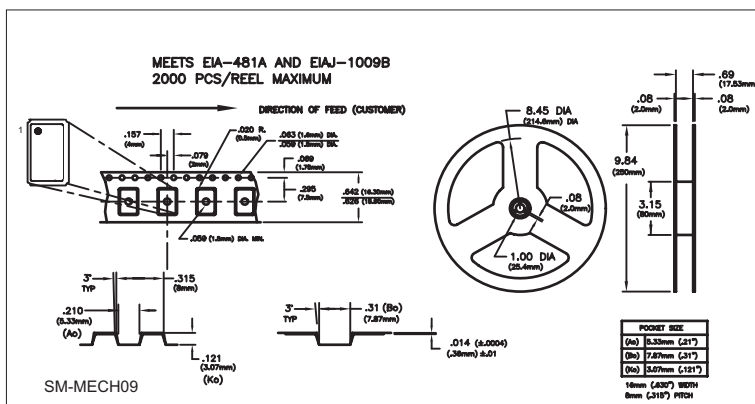

Specifications subject to change without notice. All dimensions in inches. © Copyright 2007 The Connor-Winfield Corporation

Pad Connections

Table 7.0

Pin	Function
1	Control Voltage
2	Enable / Disable
3	Ground (Case)
4	Output
5	N/C
6	Vcc

Enable / Disable Function

Table 8.0

Enable / Disable Function (Pad 2)	Output
High or Open	Enable
Low	Disable (High Impedance)

Suggested Pad Layout

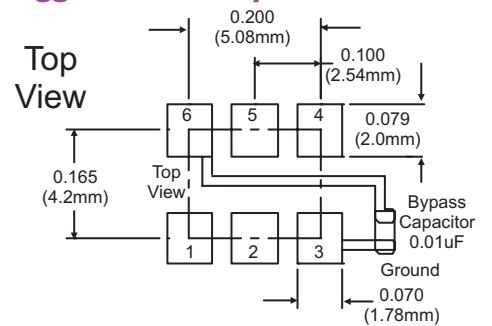

Solder Profile

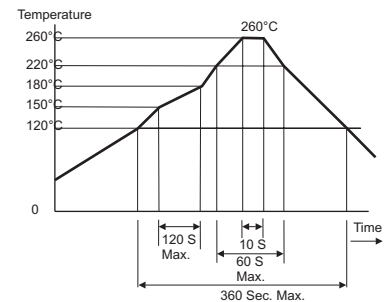

Ordering Information

V802 - 125.0M

VCXO SERIES CENTER FREQUENCY

US Headquarters:
630-851-4722
European Headquarters:
+353-61-472221

Bulletin	Vx514
Page	2 of 2
Revision	03
Date	05 Dec 2007