

MBR40250, MBR40250T, MBRF40250T

250 V, 40 A SWITCHMODE™ Schottky Power Rectifier

Features

- 250 V Blocking Voltage
- Low Forward Voltage Drop, $V_F = 0.86$ V
- Soft Recovery Characteristic, $T_{RR} < 35$ ns
- Low Reverse Current, $I_R = 30$ μ A
- Stable Switching Performance Over Temperature
- Pb-Free Packages are Available*

Benefits

- Reduces or Eliminates Reverse Recovery Oscillations
- Minimizes Need for EMI Filtering
- Reduces Switching Losses
- Improved Efficiency

Applications

- Power Supply
- Power Management
- Automotive
- Instrumentation

Mechanical Characteristics

- Case: Epoxy, Molded
- Weight: 1.9 grams (approximately)
- Finish: All External Surfaces Corrosion Resistant and Terminal Leads are Readily Solderable
- Lead Temperature for Soldering Purposes:
260°C Max. for 10 Seconds
- Epoxy Meets UL 94 V-0 at 0.125 in



ON Semiconductor®

<http://onsemi.com>

SCHOTTKY RECTIFIER 40 AMPERES, 250 VOLTS

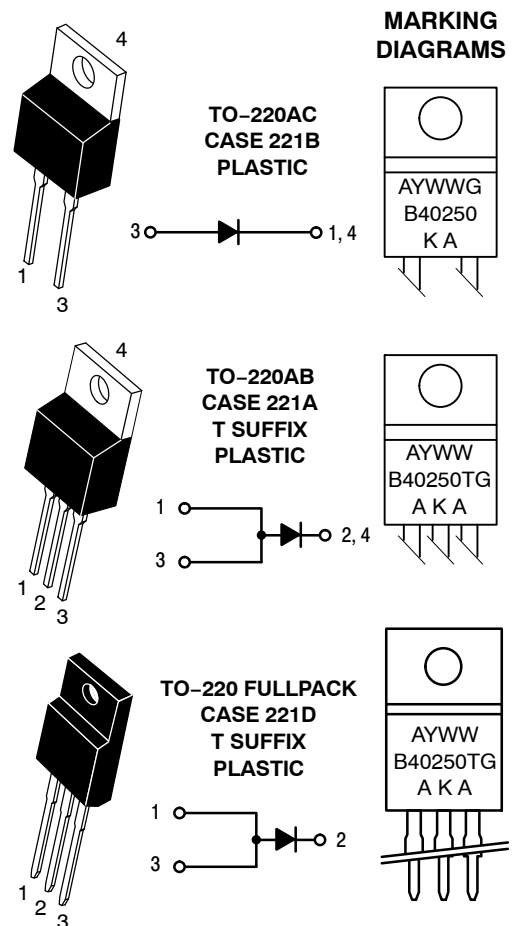

B40250 = Device Code
 T = 3 pins
 A = Assembly Location
 Y = Year
 WW = Work Week
 G = Pb-Free Package
 KA, AKA = Polarity Designator

ORDERING INFORMATION

See detailed ordering and shipping information in the package dimensions section on page 4 of this data sheet.

*For additional information on our Pb-Free strategy and soldering details, please download the ON Semiconductor Soldering and Mounting Techniques Reference Manual, SOLDERRM/D.

MBR40250, MBR40250T, MBRF40250T

MAXIMUM RATINGS

Rating	Symbol	Value	Unit
Peak Repetitive Reverse Voltage Working Peak Reverse Voltage DC Blocking Voltage	V_{RRM} V_{RWM} V_R	250	V
Average Rectified Forward Current (Rated V_R) $T_C = 82^\circ\text{C}$ MBR40250, MBR40250T (Rated V_R) $T_C = 46^\circ\text{C}$ MBRF40250T	$I_{F(AV)}$	40	A
Peak Repetitive Forward Current (Rated V_R , Square Wave, 20 kHz) $T_C = 82^\circ\text{C}$ MBR40250, MBR40250T (Rated V_R , Square Wave, 20 kHz) $T_C = 46^\circ\text{C}$ MBRF40250T	I_{FRM}	80	A
Nonrepetitive Peak Surge Current (Surge applied at rated load conditions halfwave, single phase, 20 kHz)	I_{FSM}	150	A
Storage Temperature	T_{stg}	-65 to +175	$^\circ\text{C}$
Operating Junction Temperature	T_J	-65 to +150	$^\circ\text{C}$
Voltage Rate of Change (Rated V_R)	dv/dt	10,000	V/ μs

Stresses exceeding Maximum Ratings may damage the device. Maximum Ratings are stress ratings only. Functional operation above the Recommended Operating Conditions is not implied. Extended exposure to stresses above the Recommended Operating Conditions may affect device reliability.

THERMAL CHARACTERISTICS

Rating	Symbol	Value	Unit
Maximum Thermal Resistance Junction-to-Case MBR40250(T) MBRF40250	$R_{\theta JC}$	2.0	$^\circ\text{C}/\text{W}$
	$R_{\theta JA}$	3.0	
Junction-to-Ambient MBR40250(T) MBRF40250	$R_{\theta JA}$	60	
	$R_{\theta JA}$	50	

ELECTRICAL CHARACTERISTICS

Rating	Symbol	Value	Unit
Maximum Instantaneous Forward Voltage (Note 1) $I_F = 20\text{ A}, T_C = 25^\circ\text{C}$ $I_F = 20\text{ A}, T_C = 125^\circ\text{C}$ $I_F = 40\text{ A}, T_C = 25^\circ\text{C}$ $I_F = 40\text{ A}, T_C = 125^\circ\text{C}$	V_F	0.86 0.71 0.97 0.86	V
Maximum Instantaneous Reverse Current (Note 1) Rated DC Voltage, $T_C = 25^\circ\text{C}$ Rated DC Voltage, $T_C = 125^\circ\text{C}$	I_R	0.03 30	mA
Maximum Reverse Recovery Time $I_F = 1.0\text{ A}, di/dt = 50\text{ A}/\mu\text{s}, T_C = 25^\circ\text{C}$	t_{rr}	35	ns

DYNAMIC CHARACTERISTICS

Capacitance $V_R = -5.0\text{ V}, T_C = 25^\circ\text{C}, \text{Frequency} = 1.0\text{ MHz}$	C_T	500	pF
---	-------	-----	----

1. Pulse Test: Pulse Width = 300 μs , Duty Cycle $\leq 2.0\%$.

MBR40250, MBR40250T, MBRF40250T

TYPICAL CHARACTERISTICS

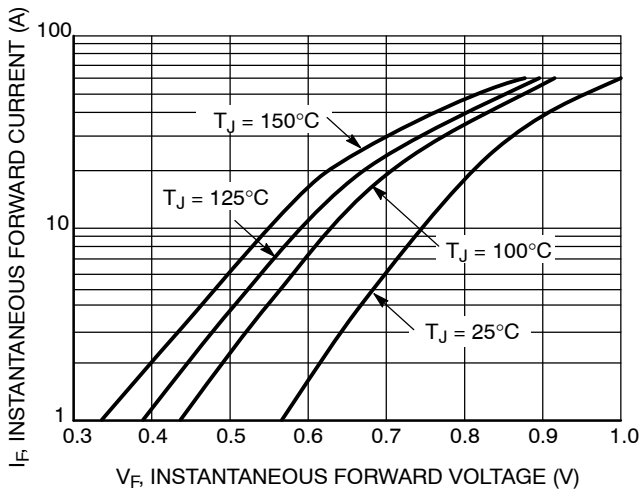

Figure 1. Typical Forward Voltage

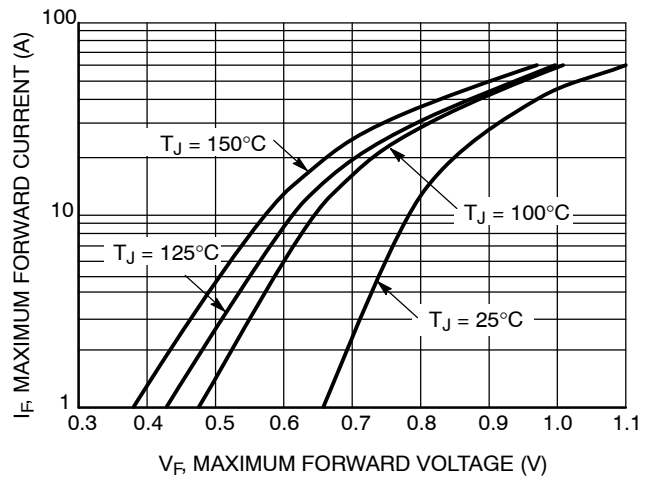

Figure 2. Maximum Forward Voltage

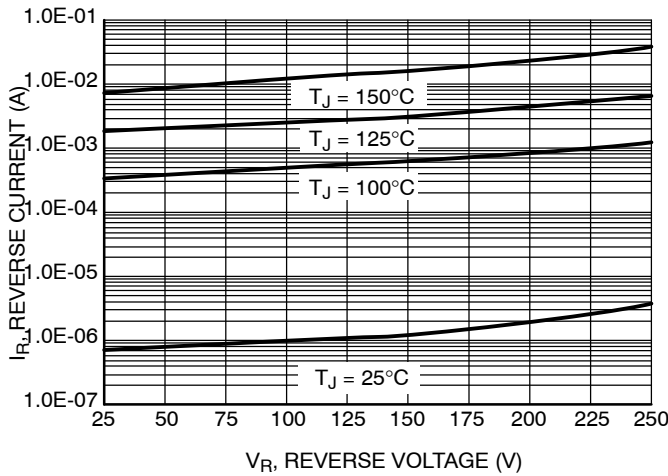

Figure 3. Typical Reverse Current

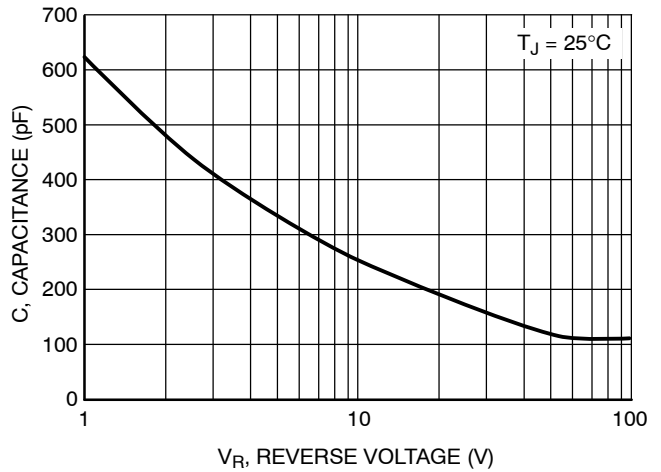

Figure 4. Typical Capacitance

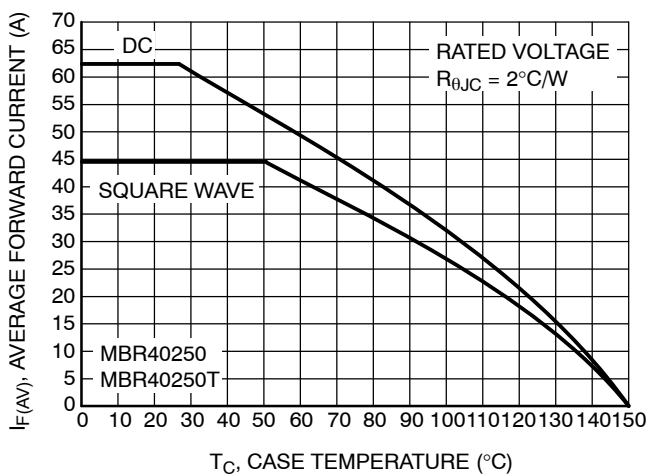

Figure 5. Current Derating (Case) for MBR40250 and MBR40250T

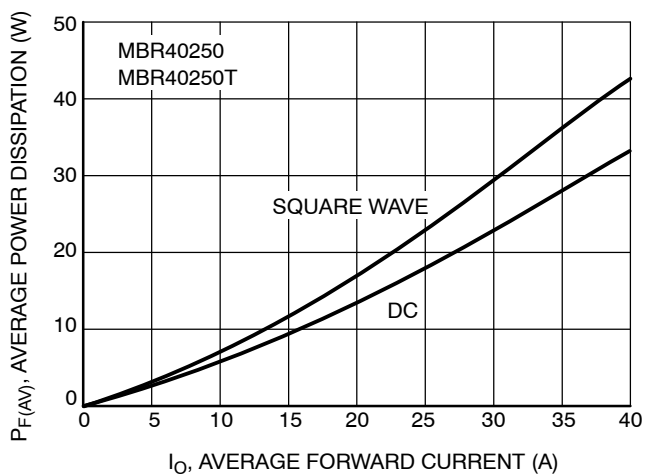

Figure 6. Forward Power Dissipation for MBR40250 and MBR40250T

MBR40250, MBR40250T, MBRF40250T

TYPICAL CHARACTERISTICS

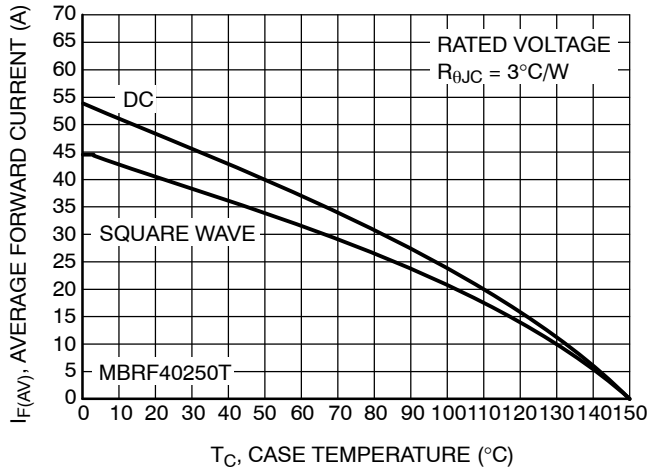

Figure 7. Current Derating (Case) for MBRF40250T

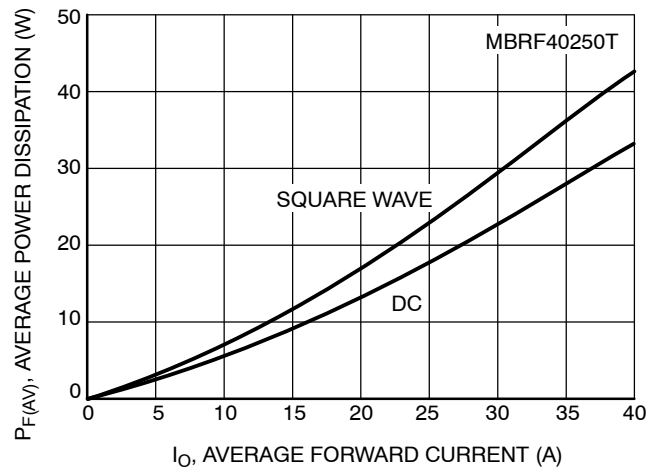

Figure 8. Forward Power Dissipation for MBRF40250T

ORDERING INFORMATION

Device	Package	Shipping†
MBR40250	TO-220AC	50 Units / Rail
MBR40250G	TO-220AC (Pb-Free)	
MBR40250T	TO-220AB	50 Units / Rail
MBR40250TG	TO-220AB (Pb-Free)	
MBRF40250T	TO-220 FULLPACK	50 Units / Rail
MBRF40250TG	TO-220 FULLPACK (Pb-Free)	

MBR40250, MBR40250T, MBRF40250T

PACKAGE DIMENSIONS

TO-220 CASE 221A-09 ISSUE AF

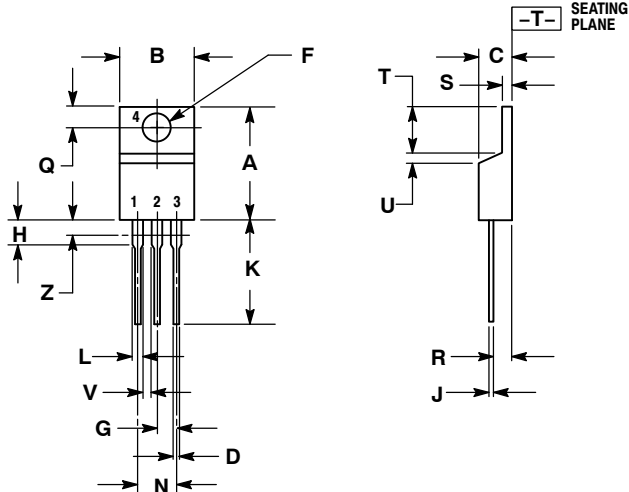

NOTES:

1. DIMENSIONING AND TOLERANCING PER ANSI Y14.5M, 1982.
2. CONTROLLING DIMENSION: INCH.
3. DIMENSION Z DEFINES A ZONE WHERE ALL BODY AND LEAD IRREGULARITIES ARE ALLOWED.

DIM	INCHES		MILLIMETERS	
	MIN	MAX	MIN	MAX
A	0.570	0.620	14.48	15.75
B	0.380	0.405	9.66	10.28
C	0.160	0.190	4.07	4.82
D	0.025	0.035	0.64	0.88
F	0.142	0.161	3.61	4.09
G	0.095	0.105	2.42	2.66
H	0.110	0.155	2.80	3.93
J	0.014	0.025	0.36	0.64
K	0.500	0.562	12.70	14.27
L	0.045	0.060	1.15	1.52
N	0.190	0.210	4.83	5.33
Q	0.100	0.120	2.54	3.04
R	0.080	0.110	2.04	2.79
S	0.045	0.055	1.15	1.39
T	0.235	0.255	5.97	6.47
U	0.000	0.050	0.00	1.27
V	0.045	---	1.15	---
Z	---	0.080	---	2.04

STYLE 6:

- PIN 1. ANODE
2. CATHODE
3. ANODE
4. CATHODE

TO-220AC CASE 221B-04 ISSUE E

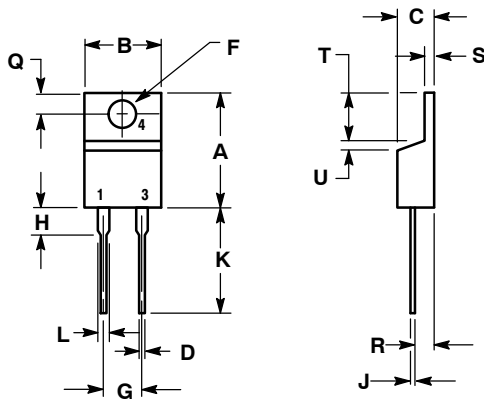

NOTES:

1. DIMENSIONING AND TOLERANCING PER ANSI Y14.5M, 1982.
2. CONTROLLING DIMENSION: INCH.

DIM	INCHES		MILLIMETERS	
	MIN	MAX	MIN	MAX
A	0.595	0.620	15.11	15.75
B	0.380	0.405	9.65	10.29
C	0.160	0.190	4.06	4.82
D	0.025	0.035	0.64	0.89
F	0.142	0.161	3.61	4.09
G	0.190	0.210	4.83	5.33
H	0.110	0.130	2.79	3.30
J	0.014	0.025	0.36	0.64
K	0.500	0.562	12.70	14.27
L	0.045	0.060	1.14	1.52
Q	0.100	0.120	2.54	3.04
R	0.080	0.110	2.04	2.79
S	0.045	0.055	1.14	1.39
T	0.235	0.255	5.97	6.48
U	0.000	0.050	0.000	1.27

MBR40250, MBR40250T, MBRF40250T

PACKAGE DIMENSIONS

TO-220 FULLPAK
CASE 221D-03
ISSUE J

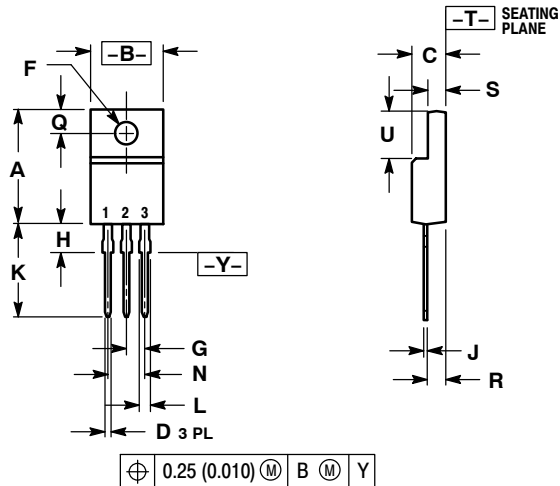

NOTES:

1. DIMENSIONING AND TOLERANCING PER ANSI Y14.5M, 1982.
2. CONTROLLING DIMENSION: INCH
3. 221D-01 THRU 221D-02 OBSOLETE, NEW STANDARD 221D-03.

DIM	INCHES		MILLIMETERS	
	MIN	MAX	MIN	MAX
A	0.617	0.635	15.67	16.12
B	0.392	0.419	9.96	10.63
C	0.177	0.193	4.50	4.90
D	0.024	0.039	0.60	1.00
F	0.116	0.129	2.95	3.28
G	0.100 BSC		2.54 BSC	
H	0.118	0.135	3.00	3.43
J	0.018	0.025	0.45	0.63
K	0.503	0.541	12.78	13.73
L	0.048	0.058	1.23	1.47
N	0.200 BSC		5.08 BSC	
Q	0.122	0.138	3.10	3.50
R	0.099	0.117	2.51	2.96
S	0.092	0.113	2.34	2.87
U	0.239	0.271	6.06	6.88

SWITCHMODE is a trademark of Semiconductor Components Industries, LLC (SCILLC).

ON Semiconductor and  are registered trademarks of Semiconductor Components Industries, LLC (SCILLC). SCILLC reserves the right to make changes without further notice to any products herein. SCILLC makes no warranty, representation or guarantee regarding the suitability of its products for any particular purpose, nor does SCILLC assume any liability arising out of the application or use of any product or circuit, and specifically disclaims any and all liability, including without limitation special, consequential or incidental damages. "Typical" parameters which may be provided in SCILLC data sheets and/or specifications can and do vary in different applications and actual performance may vary over time. All operating parameters, including "Typicals" must be validated for each customer application by customer's technical experts. SCILLC does not convey any license under its patent rights nor the rights of others. SCILLC products are not designed, intended, or authorized for use as components in systems intended for surgical implant into the body, or other applications intended to support or sustain life, or for any other application in which the failure of the SCILLC product could create a situation where personal injury or death may occur. Should Buyer purchase or use SCILLC products for any such unintended or unauthorized application, Buyer shall indemnify and hold SCILLC and its officers, employees, subsidiaries, affiliates, and distributors harmless against all claims, costs, damages, and expenses, and reasonable attorney fees arising out of, directly or indirectly, any claim of personal injury or death associated with such unintended or unauthorized use, even if such claim alleges that SCILLC was negligent regarding the design or manufacture of the part. SCILLC is an Equal Opportunity/Affirmative Action Employer. This literature is subject to all applicable copyright laws and is not for resale in any manner.

PUBLICATION ORDERING INFORMATION

LITERATURE FULFILLMENT:
Literature Distribution Center for ON Semiconductor
P.O. Box 5163, Denver, Colorado 80217 USA
Phone: 303-675-2175 or 800-344-3860 Toll Free USA/Canada
Fax: 303-675-2176 or 800-344-3867 Toll Free USA/Canada
Email: orderlit@onsemi.com

N. American Technical Support: 800-282-9855 Toll Free
USA/Canada
Europe, Middle East and Africa Technical Support:
Phone: 421 33 790 2910
Japan Customer Focus Center
Phone: 81-3-5773-3850

ON Semiconductor Website: www.onsemi.com
Order Literature: <http://www.onsemi.com/orderlit>

For additional information, please contact your local Sales Representative

MBR40250/D