

TURBO 2 ULTRAFAST HIGH VOLTAGE RECTIFIER

Table 1: Main Product Characteristics

$I_{F(AV)}$	Up to 20 A
V_{RRM}	600 V
T_j	175°C
V_F (typ)	0.95 V
t_{rr} (max)	55 ns

FEATURES AND BENEFITS

- Ultrafast switching
- Low reverse current
- Low thermal resistance
- Reduces switching & conduction losses

DESCRIPTION

The STTH15L06, which is using ST Turbo 2 600V technology, is specially suited for use in switching power supplies, and industrial applications, as rectification and discontinuous mode PFC boost diode.

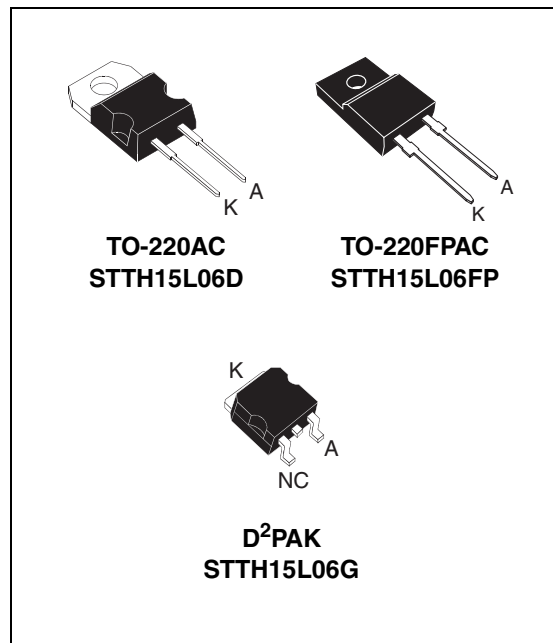


Table 2: Order Codes

Part Number	Marking
STTH15L06D	STTH15L06D
STTH15L06G	STTH15L06G
STTH15L06G-TR	STTH15L06G
STTH15L06FP	STTH15L06FP

Table 3: Absolute Ratings (limiting values)

Symbol	Parameter		Value	Unit	
V_{RRM}	Repetitive peak reverse voltage		600	V	
$I_{F(RMS)}$	RMS forward current		30	A	
$I_{F(AV)}$	Average forward current	TO-220AC / D²PAK	$T_c = 140^\circ\text{C} \quad \delta = 0.5$ $T_c = 120^\circ\text{C} \quad \delta = 0.5$	15 20	A
		TO-220FPAC	$T_c = 90^\circ\text{C} \quad \delta = 0.5$	15	
		Surge non repetitive forward current		$t_p = 10\text{ms sinusoidal}$	
T_{stg}	Storage temperature range		-65 to + 175	°C	
T_j	Maximum operating junction temperature		175	°C	

STTH15L06

Table 4: Thermal Resistance

Symbol	Parameter		Value (max).	Unit
$R_{th(j-c)}$	Junction to case	TO-220AC / D ² PAK	1.7	°C/W
		TO-220FPAC	4	

Table 5: Static Electrical Characteristics (per diode)

Symbol	Parameter	Test conditions		Min.	Typ	Max.	Unit
I_R^*	Reverse leakage current	$T_j = 25^\circ\text{C}$	$V_R = V_{RRM}$			15	μA
		$T_j = 150^\circ\text{C}$			40	400	
V_F^{**}	Forward voltage drop	$T_j = 25^\circ\text{C}$	$I_F = 15\text{A}$			1.55	V
		$T_j = 150^\circ\text{C}$			0.95	1.2	

Pulse test: * $t_p = 5\text{ ms}$, $\delta < 2\%$
 ** $t_p = 380\text{ }\mu\text{s}$, $\delta < 2\%$

To evaluate the conduction losses use the following equation: $P = 0.94 \times I_F(AV) + 0.017 I_F^2(RMS)$

Table 6: Dynamic Characteristics

Symbol	Parameter	Test conditions		Min.	Typ	Max.	Unit
t_{rr}	Reverse recovery time	$T_j = 25^\circ\text{C}$	$I_F = 0.5\text{A}$ $I_{rr} = 0.25\text{A}$ $I_R = 1\text{A}$			55	ns
			$I_F = 1\text{A}$ $di_F/dt = 50\text{ A}/\mu\text{s}$ $V_R = 30\text{V}$		60	85	
I_{RM}	Reverse recovery current	$T_j = 125^\circ\text{C}$	$I_F = 15\text{A}$ $V_R = 400\text{V}$ $di_F/dt = 100\text{ A}/\mu\text{s}$		8.5	12	A
t_{fr}	Forward recovery time	$T_j = 25^\circ\text{C}$	$I_F = 15\text{A}$ $di_F/dt = 100\text{ A}/\mu\text{s}$ $V_{FR} = 1.1 \times V_{Fmax}$			300	ns
V_{FP}	Forward recovery voltage	$T_j = 25^\circ\text{C}$	$I_F = 15\text{A}$ $di_F/dt = 100\text{ A}/\mu\text{s}$ $V_{FR} = 1.1 \times V_{Fmax}$		3		V

Figure 1: Conduction losses versus average forward current

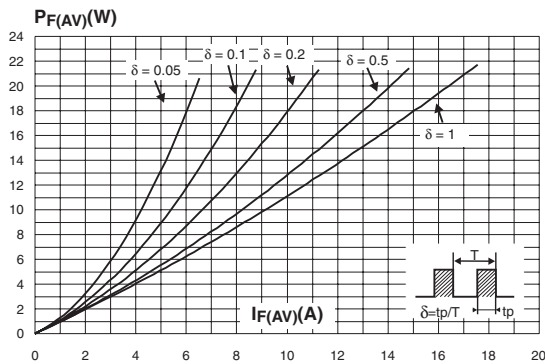


Figure 2: Forward voltage drop versus forward current

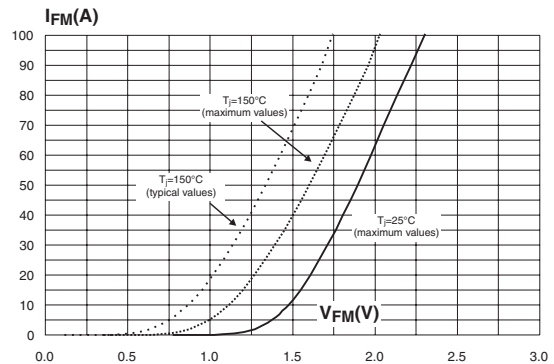


Figure 3: Relative variation of thermal impedance junction to case versus pulse duration (TO-220AC & D²PAK)

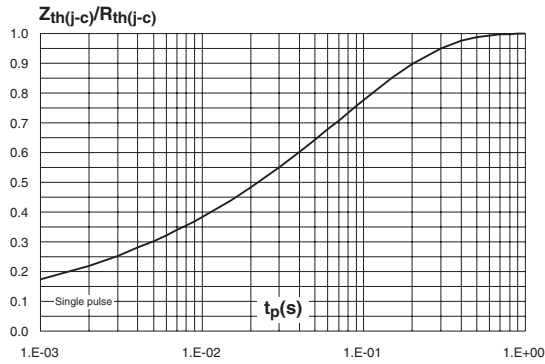


Figure 4: Relative variation of thermal impedance junction to case versus pulse duration (TO-220FPAC)

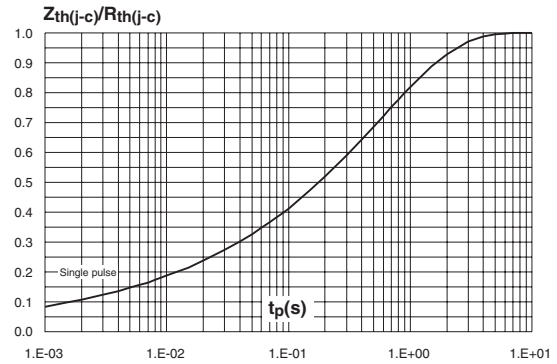


Figure 5: Peak reverse recovery current versus dI_F/dt (typical values)

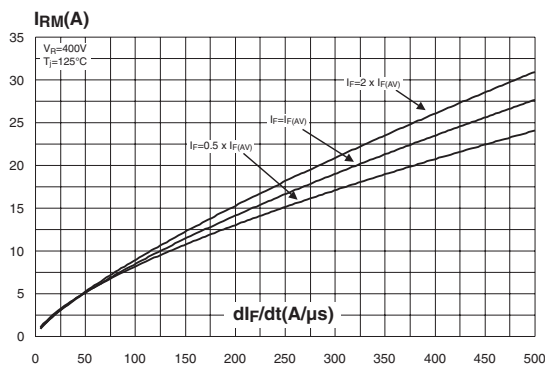


Figure 6: Reverse recovery time versus dI_F/dt (typical values)

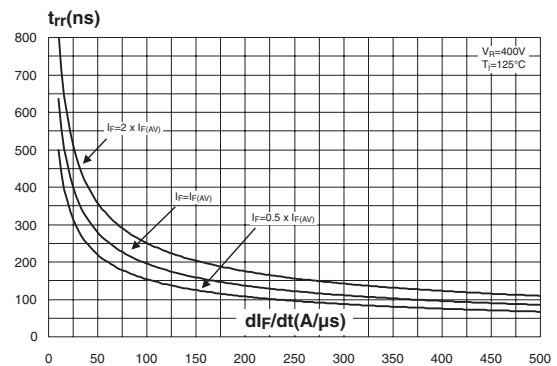


Figure 7: Reverse recovery charges versus dI_F/dt (typical values)

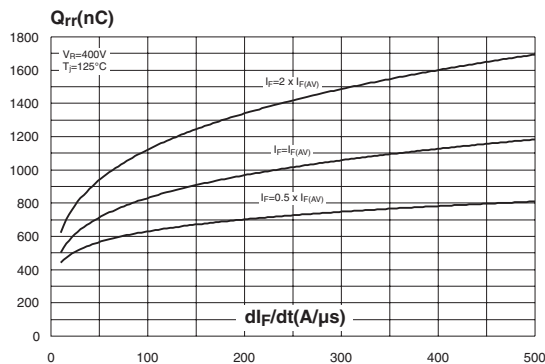


Figure 8: Reverse recovery softness factor versus dI_F/dt (typical values)

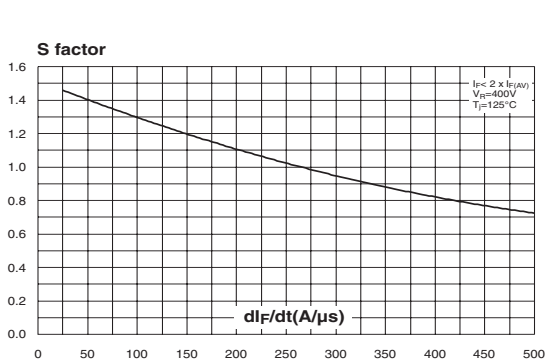


Figure 9: Relative variations of dynamic parameters versus junction temperature

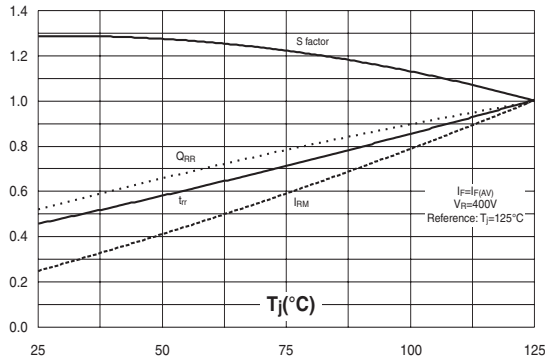


Figure 10: Transient peak forward voltage versus di_F/dt (typical values)

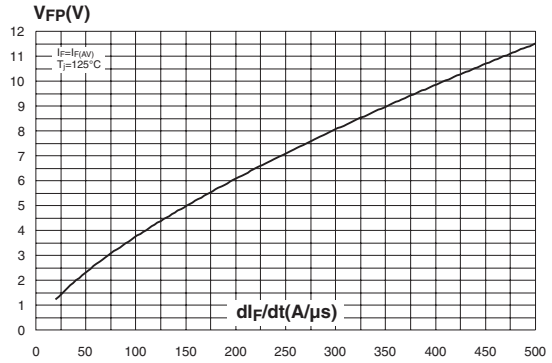


Figure 11: Forward recovery time versus di_F/dt (typical values)

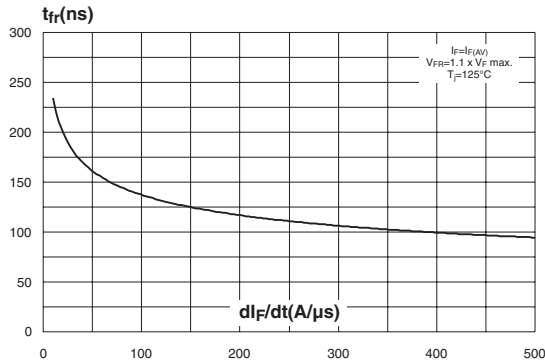


Figure 12: Junction capacitance versus reverse voltage applied (typical values)

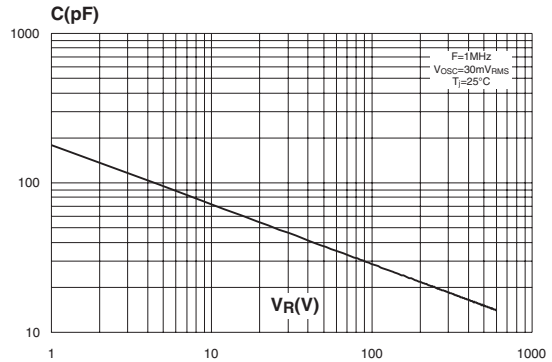


Figure 13: Thermal resistance junction to ambient versus copper surface under tab (epoxy FR4, $e_{CU} = 35\mu m$) (D²PAK)

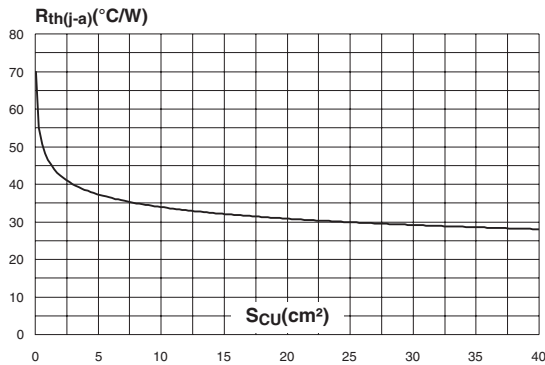


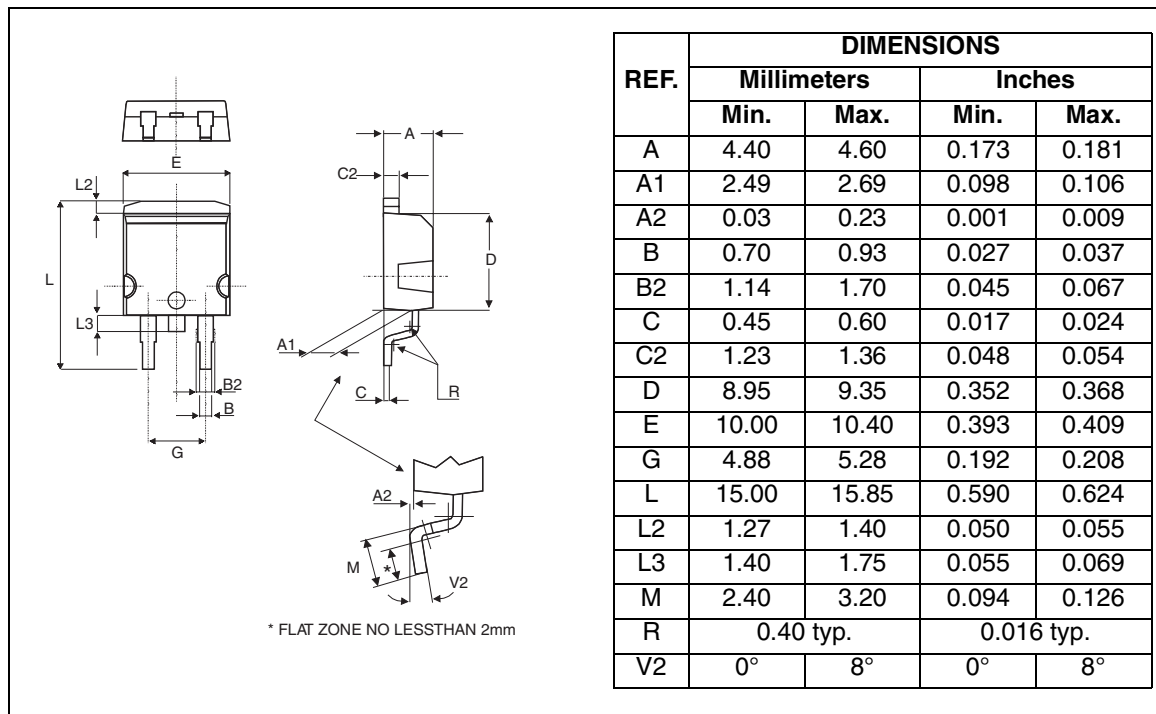
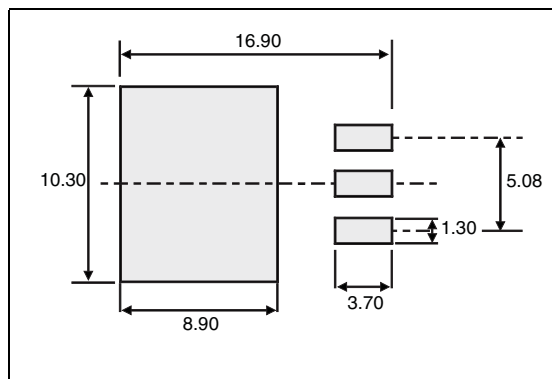
Figure 14: D²PAK Package Mechanical DataFigure 15: D²PAK Foot Print Dimensions
(in millimeters)

Figure 16: TO-220FPAC Package Mechanical Data

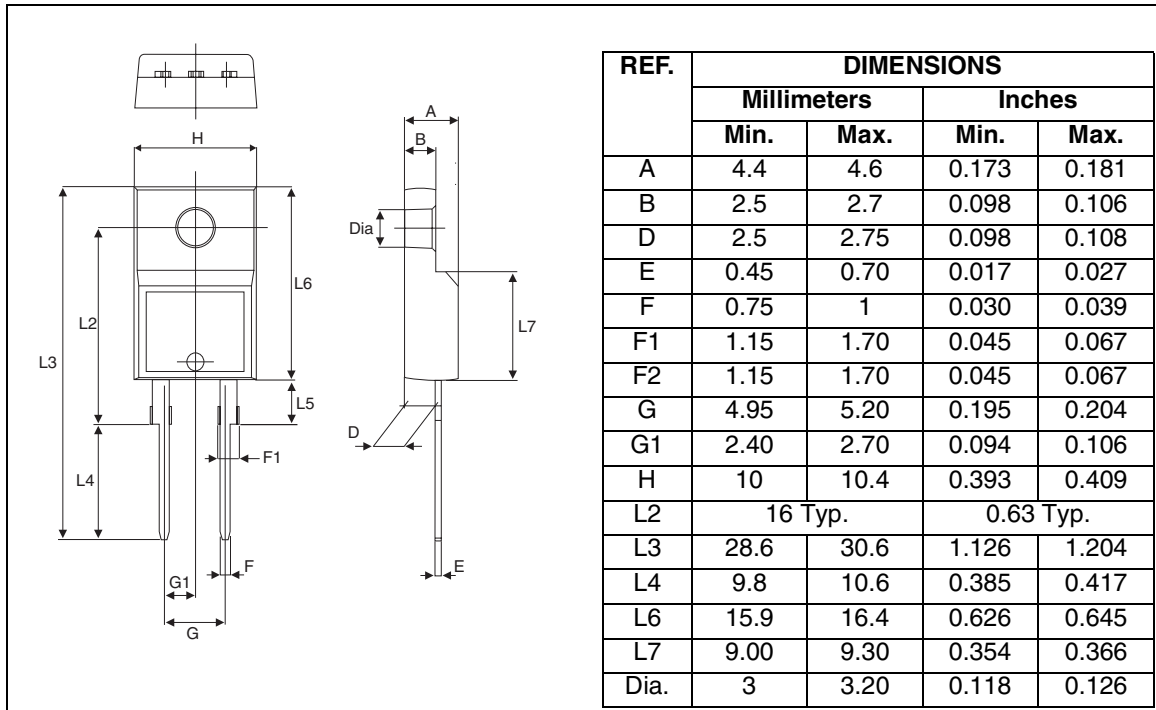


Figure 17: TO-220AC Package Mechanical Data

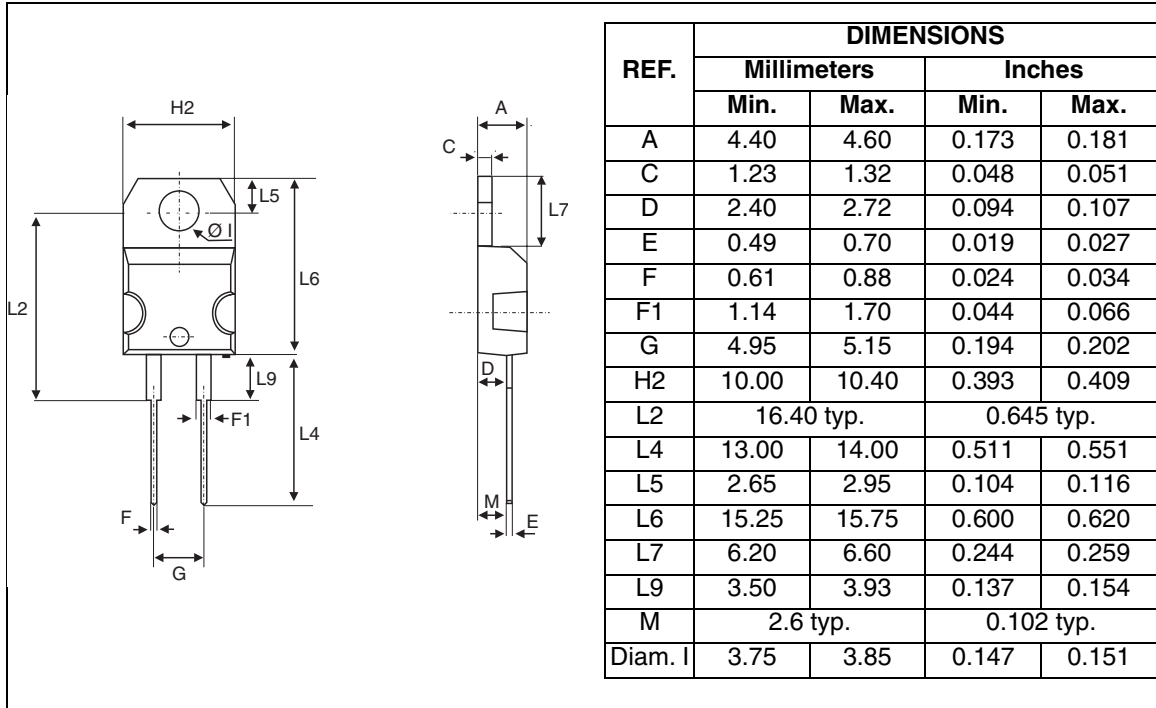


Table 7: Ordering Information

Ordering type	Marking	Package	Weight	Base qty	Delivery mode
STTH15L06D	STTH15L06D	TO-220AC	1.90 g	50	Tube
STTH15L06G	STTH15L06G	D ² PAK	1.48 g	50	Tube
STTH15L06G-TR	STTH15L06G	D ² PAK	1.48 g	1000	Tape & eel
STTH15L06FP	STTH15L06FP	TO-220FPAC	1.70 g	50	Tube

- Epoxy meets UL94, V0
- Cooling method: by conduction (C)
- Recommended torque value: 0.8 m.N. (TO-220FPAC) / 0.55 m.N. (TO-220AC)
- Maximum torque value: 1.0 m.N. (TO-220FPAC) / 0.70 m.N. (TO-220AC)

Table 8: Revision History

Date	Revision	Description of Changes
07-Sep-2004	1	First issue

Information furnished is believed to be accurate and reliable. However, STMicroelectronics assumes no responsibility for the consequences of use of such information nor for any infringement of patents or other rights of third parties which may result from its use. No license is granted by implication or otherwise under any patent or patent rights of STMicroelectronics. Specifications mentioned in this publication are subject to change without notice. This publication supersedes and replaces all information previously supplied. STMicroelectronics products are not authorized for use as critical components in life support devices or systems without express written approval of STMicroelectronics.

The ST logo is a registered trademark of STMicroelectronics.
All other names are the property of their respective owners

© 2004 STMicroelectronics - All rights reserved

STMicroelectronics group of companies

Australia - Belgium - Brazil - Canada - China - Czech Republic - Finland - France - Germany - Hong Kong - India - Israel - Italy - Japan -
Malaysia - Malta - Morocco - Singapore - Spain - Sweden - Switzerland - United Kingdom - United States of America
www.st.com