



STPS10L25D/G

LOW DROP POWER SCHOTTKY RECTIFIER

MAIN PRODUCT CHARACTERISTICS

$I_{F(AV)}$	10 A
V_{RRM}	25 V
T_j (max)	150 °C
V_F (max)	0.35 V

FEATURES AND BENEFITS

- VERY LOW FORWARD VOLTAGE DROP FOR LESS POWER DISSIPATION
- OPTIMIZED CONDUCTION / REVERSE LOSSES TRADE-OFF WHICH MEANS THE HIGHEST EFFICIENCY IN THE APPLICATIONS
- AVALANCHE CAPABILITY SPECIFIED

DESCRIPTION

Single Schottky rectifier suited to Switched Mode Power Supplies and high frequency DC to DC converters.

This device is especially intended for use as a rectifier at the secondary of 3.3V SMPS units.

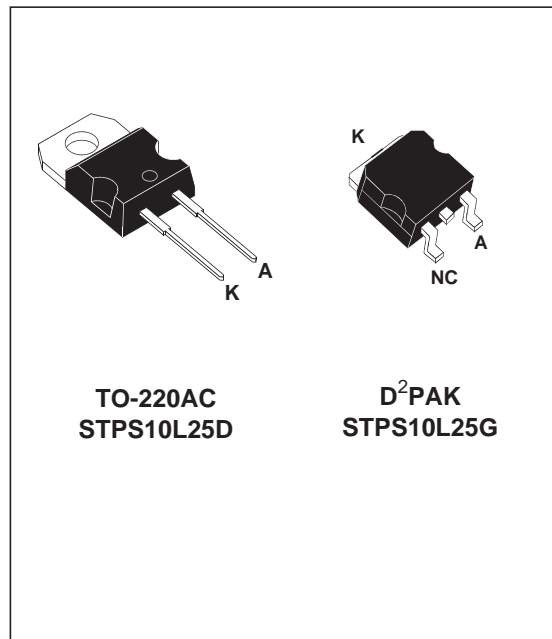

TO-220AC
STPS10L25D

D²PAK
STPS10L25G

ABSOLUTE RATINGS (limiting values)

Symbol	Parameter	Value	Unit
V_{RRM}	Repetitive peak reverse voltage	25	V
$I_{F(RMS)}$	RMS forward current	30	A
$I_{F(AV)}$	Average forward current	$T_c = 140^\circ\text{C} \quad \delta = 0.5$	A
I_{FSM}	Surge non repetitive forward current	$t_p = 10 \text{ ms Sinusoidal}$	A
I_{RRM}	Repetitive peak reverse current	$t_p = 2 \mu\text{s square } F = 1\text{kHz}$	A
I_{RSM}	Non repetitive peak reverse current	$t_p = 100 \mu\text{s square}$	A
P_{ARM}	Repetitive peak avalanche power	$t_p = 1 \mu\text{s} \quad T_j = 25^\circ\text{C}$	W
T_{stg}	Storage temperature range	- 65 to + 150	°C
T_j	Maximum operating junction temperature *	150	°C
dV/dt	Critical rate of rise of reverse voltage	10000	V/ μs

* : $\frac{dP_{tot}}{dT_j} < \frac{1}{R_{th}(j-a)}$ thermal runaway condition for a diode on its own heatsink

STPS10L25D/G

THERMAL RESISTANCE

Symbol	Parameter	Value	Unit
$R_{th(j-c)}$	Junction to case	1.5	$^{\circ}\text{C}/\text{W}$

STATIC ELECTRICAL CHARACTERISTICS

Symbol	Tests Conditions	Tests Conditions	Min.	Typ.	Max.	Unit
I_R^*	Reverse leakage current	$T_j = 25^{\circ}\text{C}$	$V_R = V_{RRM}$		800	μA
		$T_j = 125^{\circ}\text{C}$		135	260	mA
V_F^*	Forward voltage drop	$T_j = 25^{\circ}\text{C}$	$I_F = 10\text{ A}$		0.46	V
		$T_j = 125^{\circ}\text{C}$	$I_F = 10\text{ A}$	0.30	0.35	
		$T_j = 25^{\circ}\text{C}$	$I_F = 20\text{ A}$		0.55	
		$T_j = 125^{\circ}\text{C}$	$I_F = 20\text{ A}$	0.41	0.48	

Pulse test: * $t_p = 380\ \mu\text{s}$, $\delta < 2\%$

To evaluate the maximum conduction losses use the following equation :

$$P = 0.22 \times I_{F(AV)} + 0.013 I_{F(RMS)}^2$$

Fig. 1: Average forward power dissipation versus average forward current.

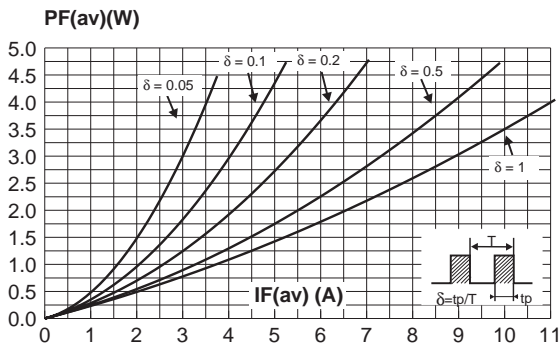

Fig. 3: Normalized avalanche power derating versus pulse duration.

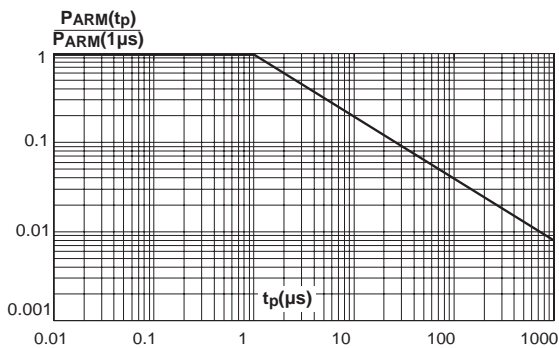

Fig. 2: Average forward current versus ambient temperature ($\delta = 0.5$).

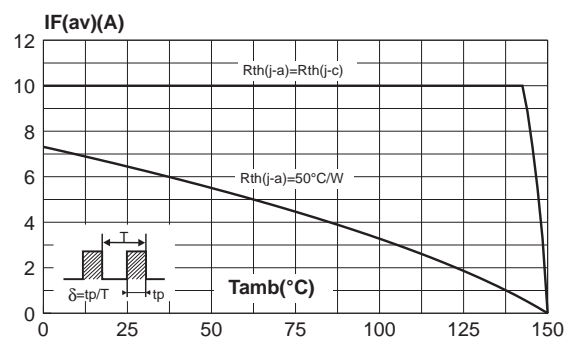

Fig. 4: Normalized avalanche power derating versus junction temperature.

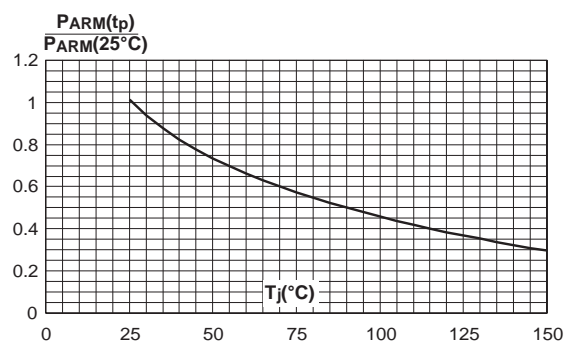

Fig. 5: Non repetitive surge peak forward current versus overload duration (maximum values).

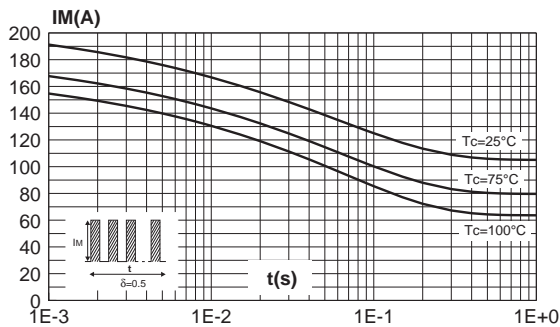

Fig. 6: Relative variation of thermal impedance junction to case versus pulse duration.

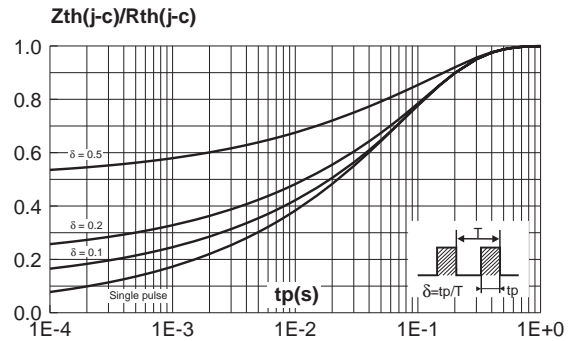

Fig. 7: Reverse leakage current versus reverse voltage applied (typical values).

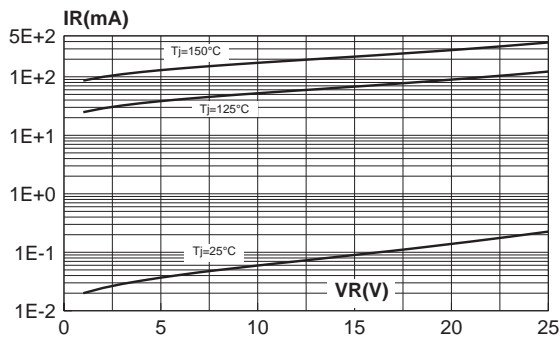

Fig. 8: Junction capacitance versus reverse voltage applied (typical values).

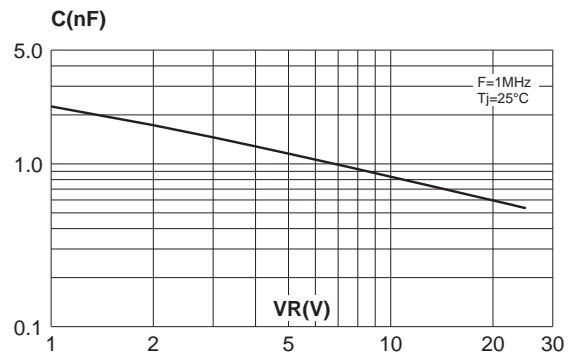

Fig. 9: Forward voltage drop versus forward current (maximum values).

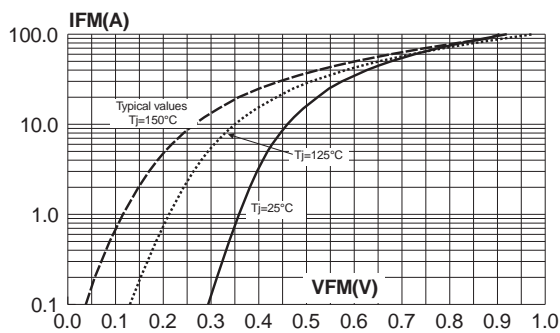
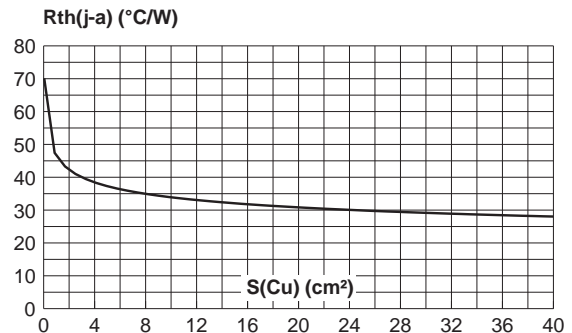
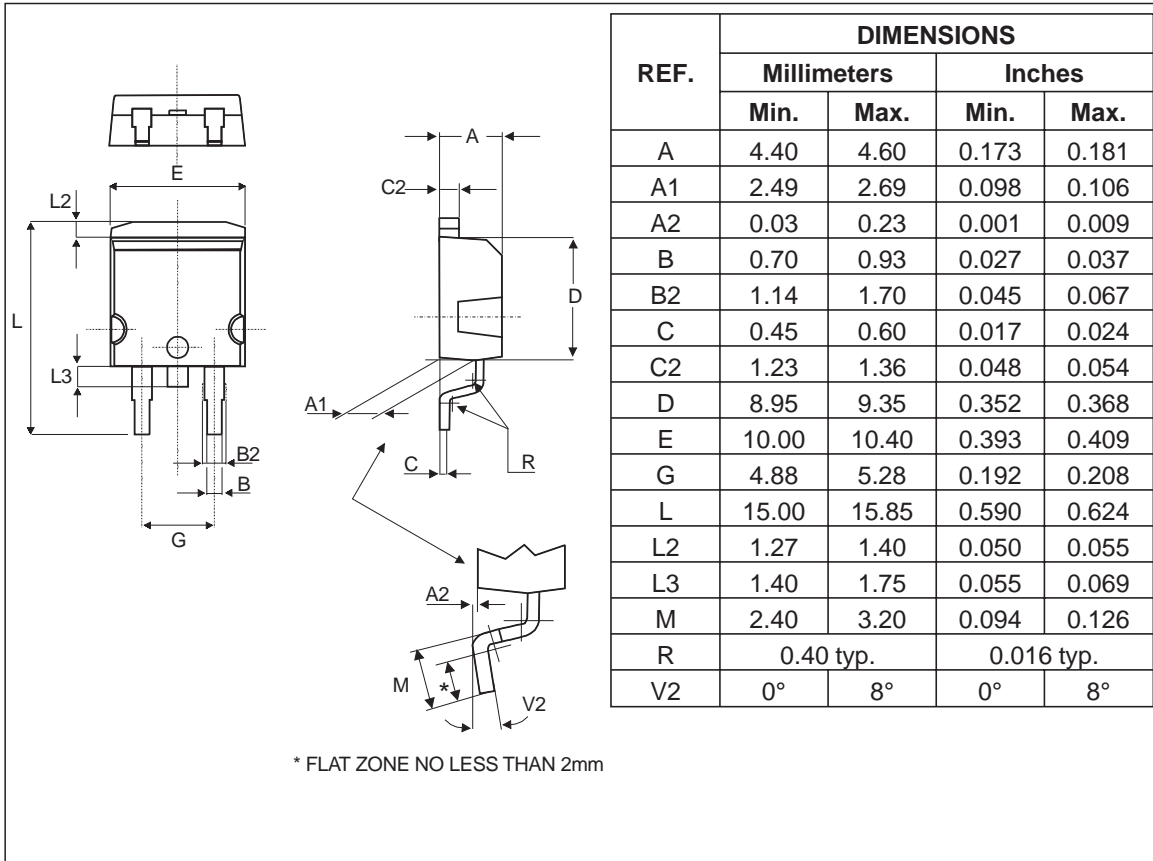

Fig. 10: Thermal resistance junction to ambient versus copper surface under tab (Epoxy printed circuit board FR4, copper thickness : 35 μm). (STPS10L25G only)



STPS10L25D/G

PACKAGE MECHANICAL DATA D²PAK



FOOT PRINT DIMENSIONS (in millimeters)

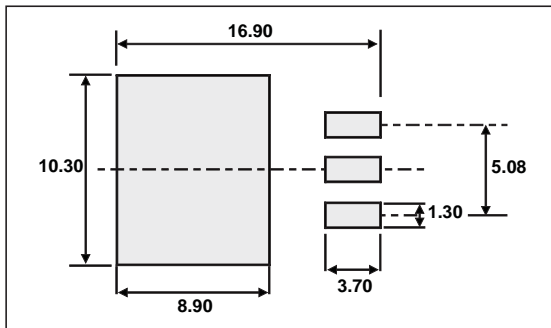

- Cooling method: by conduction (method C)

PACKAGE MECHANICAL DATA
TO-220AC

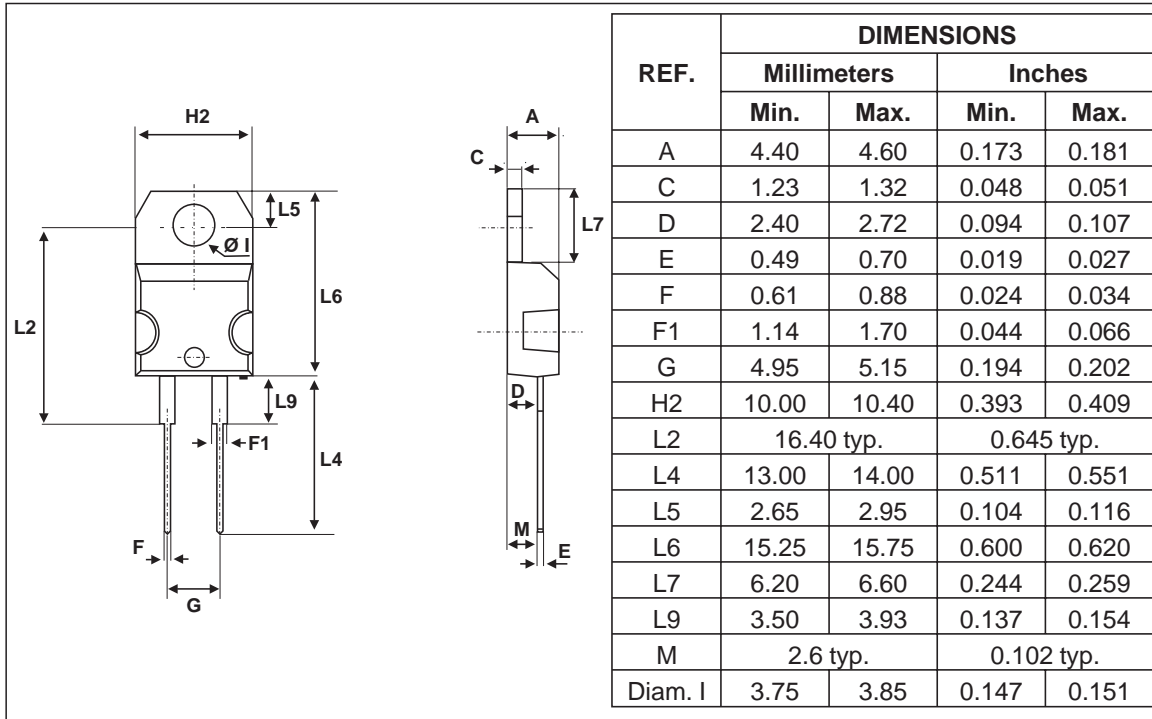

- Cooling method : C
- Recommended torque value : 0.55 m.N
- Maximum torque value : 0.70 m.N

Ordering type	Marking	Package	Weight	Base qty	Delivery mode
STPS10L25D	STPS10L25D	TO-220AC	1.86g	50	Tube
STPS10L25G	STPS10L25G	D ² PAK	1.48g	50	Tube
STPS10L25G-TR	STPS10L25G	D ² PAK	1.48g	1000	Tape & reel

- Epoxy meets UL94,V0

Information furnished is believed to be accurate and reliable. However, STMicroelectronics assumes no responsibility for the consequences of use of such information nor for any infringement of patents or other rights of third parties which may result from its use. No license is granted by implication or otherwise under any patent or patent rights of STMicroelectronics. Specifications mentioned in this publication are subject to change without notice. This publication supersedes and replaces all information previously supplied. STMicroelectronics products are not authorized for use as critical components in life support devices or systems without express written approval of STMicroelectronics.

The ST logo is a registered trademark of STMicroelectronics

© 2003 STMicroelectronics - Printed in Italy - All rights reserved.

STMicroelectronics GROUP OF COMPANIES

Australia - Brazil - Canada - China - Finland - France - Germany
Hong Kong - India - Israel - Italy - Japan - Malaysia - Malta - Morocco - Singapore
Spain - Sweden - Switzerland - United Kingdom - United States.

<http://www.st.com>

