

## Features

- Ultra Low Forward Voltage Drop
- Superior Reverse Avalanche Capability
- Patented Interlocking Clip Design for High Surge Current Capacity
- Patented Super Barrier Rectifier Technology
- Soft, Fast Switching Capability
- 150°C Operating Junction Temperature
- ±16KV ESD Protection (HBM, 3B)
- ±25KV ESD Protection (IEC61000-4-2 Level 4, Air Discharge)
- **Lead Free Finish, RoHS Compliant (Note 1)**
- **“Green” Molding Compound (No Br, Sb)**
- **Qualified to AEC-Q 101 Standards for High Reliability**

## Mechanical Data

- Case: PowerDI<sup>®</sup>123
- Case Material: Molded Plastic, “Green” Molding Compound. UL Flammability Classification Rating 94V-0
- Moisture Sensitivity: Level 1 per J-STD-020D
- Polarity Indicator: Cathode Band
- Terminals: Matte Tin Finish annealed over Copper leadframe. Solderable per MIL-STD-202, Method 208 (E3)
- Marking Information: See Page 4
- Ordering Information: See Page 4
- Weight: 0.018 grams (approximate)



Top View

## Maximum Ratings @T<sub>A</sub> = 25°C unless otherwise specified

Single phase, half wave, 60Hz, resistive or inductive load.  
For capacitance load, derate current by 20%.

Characteristic	Symbol	Value	Unit
Peak Repetitive Reverse Voltage	V <sub>RRM</sub>	30	V
Working Peak Reverse Voltage	V <sub>RWM</sub>		
DC Blocking Voltage	V <sub>RM</sub>		
RMS Reverse Voltage	V <sub>R(RMS)</sub>	21	V
Average Rectified Output Current (See Figure 1)	I <sub>O</sub>	2.0	A
Non-Repetitive Peak Forward Surge Current 8.3ms Single Half Sine-Wave Superimposed on Rated Load	I <sub>FSM</sub>	75	A
Non-Repetitive Avalanche Energy (T <sub>J</sub> = 25°C, I <sub>AS</sub> = 5A, L = 8.5 mH)	E <sub>AS</sub>	105	mJ
Repetitive Peak Avalanche Energy (T <sub>P</sub> = 1μs, T <sub>J</sub> = 25°C)	P <sub>ARM</sub>	1100	W

## Thermal Characteristics

Characteristic	Symbol	Value	Unit
Maximum Thermal Resistance			
Thermal Resistance Junction to Soldering (Note 2)	R <sub>θJS</sub>	5	°C/W
Thermal Resistance Junction to Ambient (Note 3)	R <sub>θJA</sub>	178	
Thermal Resistance Junction to Ambient (Note 4)	R <sub>θJA</sub>	123	
Operating and Storage Temperature Range	T <sub>J</sub> , T <sub>STG</sub>	-65 to +150	°C

- Notes:
1. EU Directive 2002/95/EC (RoHS). All applicable RoHS exemptions applied, see *EU Directive 2002/95/EC Annex Notes*.
  2. Theoretical R<sub>θJS</sub> calculated from the top center of the die straight down to the PCB cathode tab solder junction.
  3. FR-4 PCB, 2 oz. Copper, minimum recommended pad layout per <http://www.diodes.com/datasheets/ap02001.pdf>.
  4. Polyimide PCB, 2 oz. Copper, minimum recommended pad layout per <http://www.diodes.com/datasheets/ap02001.pdf>.

SBR and PowerDI are registered trademarks of Diodes Incorporated.

SBR2U30P1

Document number: DS30706 Rev. 6 - 2

1 of 4

[www.diodes.com](http://www.diodes.com)

October 2008

© Diodes Incorporated

**Electrical Characteristics** @T<sub>A</sub> = 25°C unless otherwise specified

Characteristic	Symbol	Min	Typ	Max	Unit	Test Condition
Reverse Breakdown Voltage (Note 5)	V <sub>(BR)R</sub>	30	-	-	V	I <sub>R</sub> = 400μA
Forward Voltage Drop	V <sub>F</sub>	-	0.22	0.26	V	I <sub>F</sub> = 0.1A, T <sub>J</sub> = 25°C I <sub>F</sub> = 1.0A, T <sub>J</sub> = 25°C I <sub>F</sub> = 2.0A, T <sub>J</sub> = 25°C I <sub>F</sub> = 0.1A, T <sub>J</sub> = 125°C I <sub>F</sub> = 1.0A, T <sub>J</sub> = 125°C I <sub>F</sub> = 2.0A, T <sub>J</sub> = 125°C
			0.31	0.35		
			0.36	0.40		
			0.12	0.15		
			0.27	0.30		
0.30	0.33					
Leakage Current (Note 5)	I <sub>R</sub>	-	75	150	μA	V <sub>R</sub> = 5V, T <sub>J</sub> = 25°C V <sub>R</sub> = 30V, T <sub>J</sub> = 25°C V <sub>R</sub> = 5V, T <sub>J</sub> = 125°C V <sub>R</sub> = 30V, T <sub>J</sub> = 125°C
			150	400	μA	
			6	15	mA	
			12	20	mA	

Notes: 5. Short duration pulse test used to minimize self-heating effect.

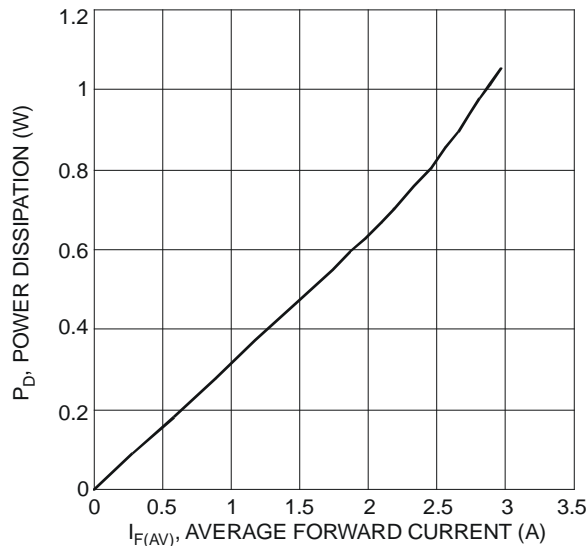

Fig. 1 Forward Power Dissipation

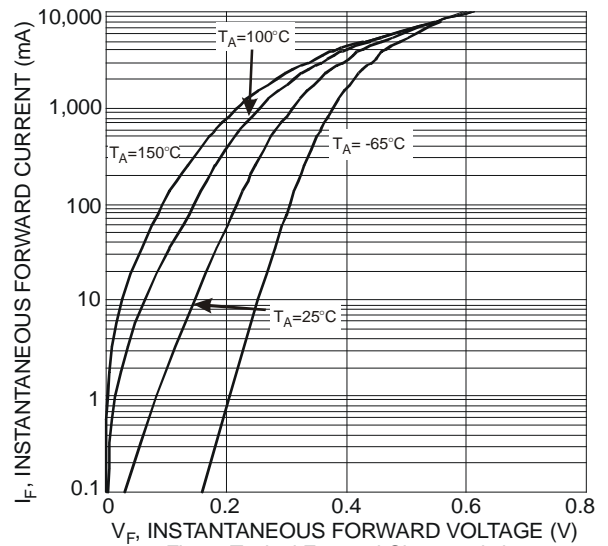

Fig. 2 Typical Forward Characteristics

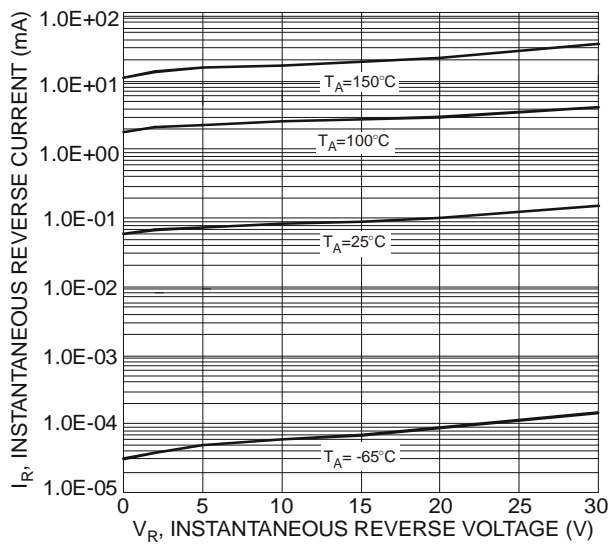

Fig. 3 Typical Reverse Characteristics

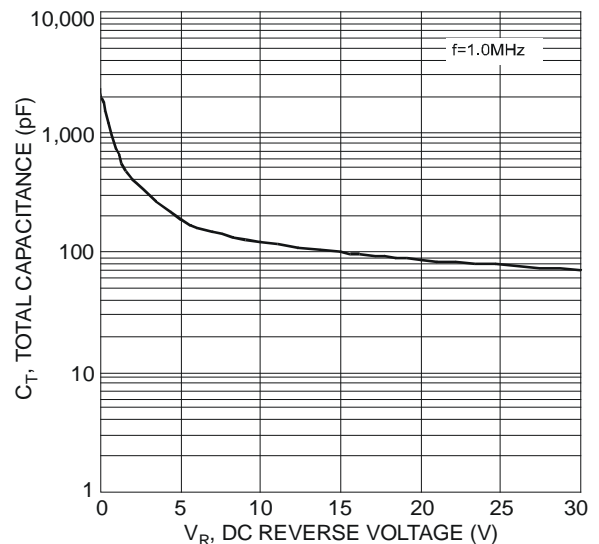

Fig. 4 Total Capacitance vs. Reverse Voltage

SBR and PowerDI are registered trademarks of Diodes Incorporated.

SBR2U30P1

Document number: DS30706 Rev. 6 - 2

2 of 4

www.diodes.com

October 2008

© Diodes Incorporated

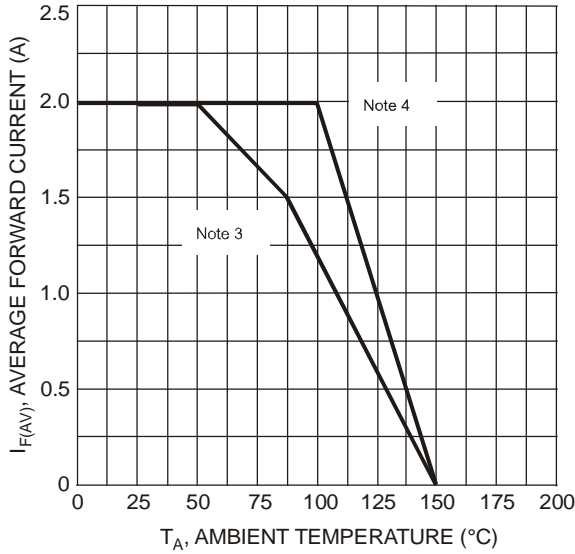

Fig. 5 Forward Current Derating Curve

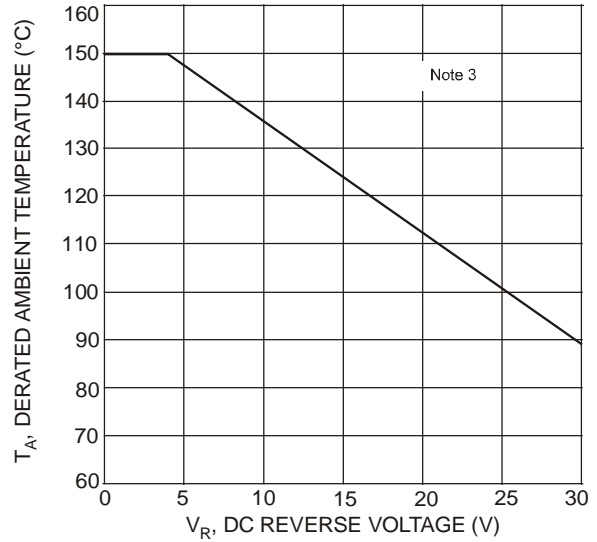

Fig. 6 Operating Temperature Derating

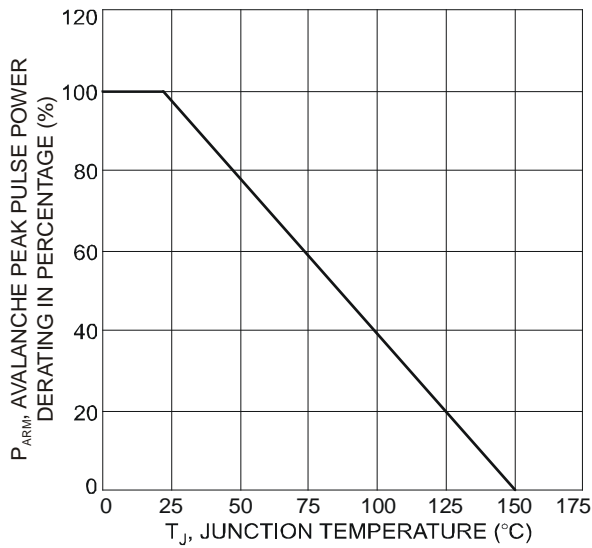

Fig. 7 Pulse Derating Curve

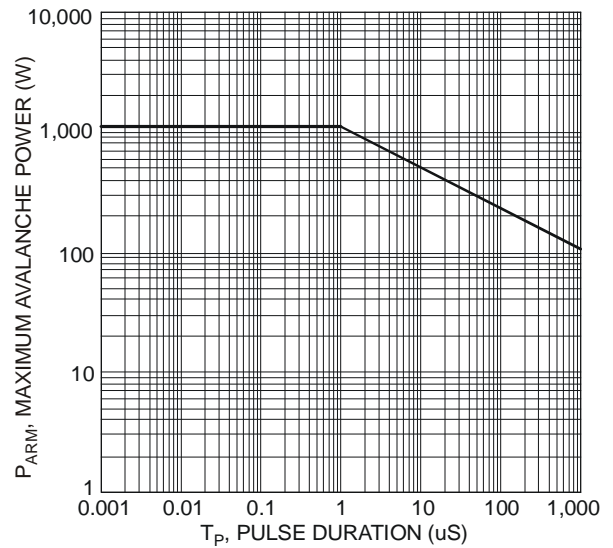

Fig. 8 Maximum Avalanche Power Curve

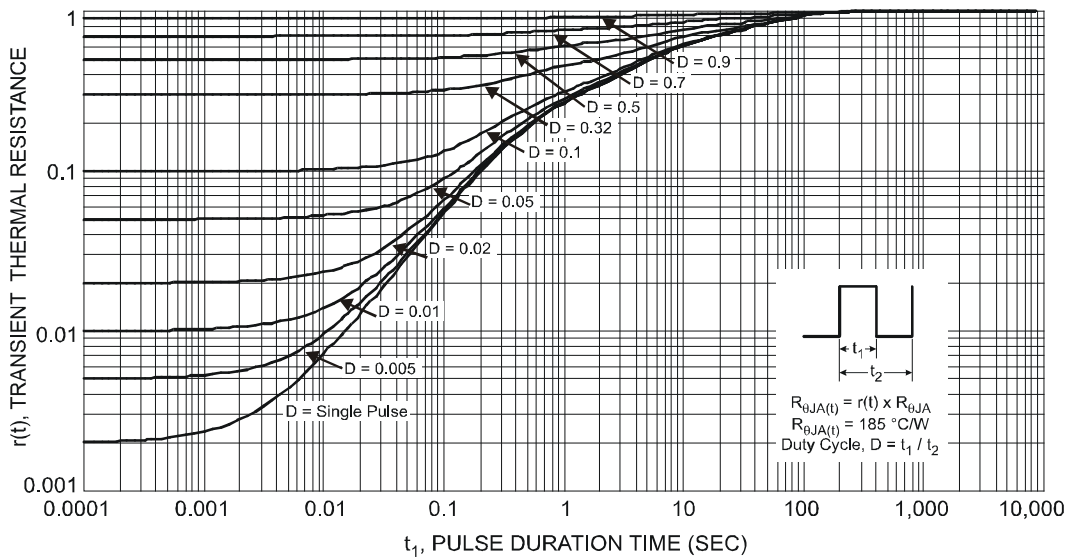

Fig. 9 Transient Thermal Resistance

SBR and PowerDI are registered trademarks of Diodes Incorporated.

SBR2U30P1

Document number: DS30706 Rev. 6 - 2

3 of 4

www.diodes.com

October 2008

© Diodes Incorporated

### Ordering Information (Note 6)

<b>Part Number</b> SBR2U30P1-7	<b>Case</b> PowerDI <sup>®</sup> 123	<b>Packaging</b> 3000/Tape & Reel
-----------------------------------	---	--------------------------------------

Notes: 6. For packaging details, go to our website at <http://www.diodes.com/datasheets/ap02007.pdf>.

### Marking Information

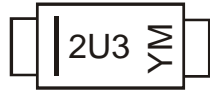

2U3 = Product Type Marking Code  
 YM = Date Code Marking  
 Y = Year (ex: T = 2006)  
 M = Month (ex: 9 = September)

#### Date Code Key

<b>Year</b>	2006	2007	2008	2009	2010	2011	2012	2013	2014	2015
<b>Code</b>	T	U	V	W	X	Y	Z	A	B	C

<b>Month</b>	Jan	Feb	Mar	Apr	May	Jun	Jul	Aug	Sep	Oct	Nov	Dec
<b>Code</b>	1	2	3	4	5	6	7	8	9	O	N	D

### Package Outline Dimensions

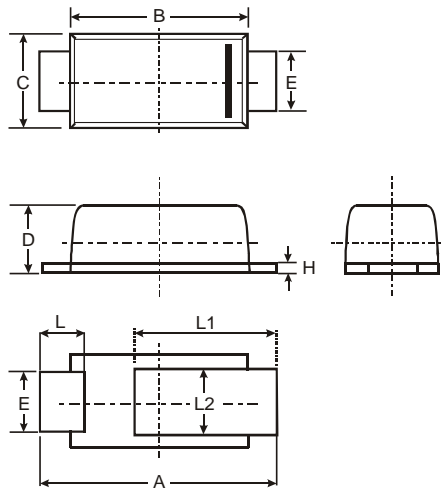

PowerDI <sup>®</sup> 123			
Dim	Min	Max	Typ
A	3.50	3.90	3.70
B	2.60	3.00	2.80
C	1.63	1.93	1.78
D	0.93	1.00	0.98
E	0.85	1.25	1.00
H	0.15	0.25	0.20
L	0.55	0.75	0.65
L1	1.80	2.20	2.00
L2	0.95	1.25	1.10
<b>All Dimensions in mm</b>			

### Suggested Pad Layout

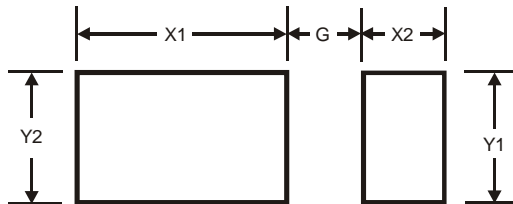

Dimensions	Value (in mm)
G	1.0
X1	2.2
X2	0.9
Y1	1.4
Y2	1.4

#### IMPORTANT NOTICE

Diodes Incorporated and its subsidiaries reserve the right to make modifications, enhancements, improvements, corrections or other changes without further notice to any product herein. Diodes Incorporated does not assume any liability arising out of the application or use of any product described herein; neither does it convey any license under its patent rights, nor the rights of others. The user of products in such applications shall assume all risks of such use and will agree to hold Diodes Incorporated and all the companies whose products are represented on our website, harmless against all damages.

#### LIFE SUPPORT

Diodes Incorporated products are not authorized for use as critical components in life support devices or systems without the expressed written approval of the President of Diodes Incorporated.

SBR and PowerDI are registered trademarks of Diodes Incorporated.