

## Features

- Low Forward Voltage Drop
- Low Reverse Leakage
- Excellent High Temperature Stability
- Patented Super Barrier Rectifier Technology
- Soft, fast switching capability
- 150°C Operating Junction Temperature
- **Lead Free/RoHS Compliant (Note 1)**
- **“Green” Device (Note 3)**

## Mechanical Data

- Case: SOD-323
- Case Material: Molded Plastic, “Green” Molding Compound.
- Moisture Sensitivity: Level 1 per J-STD-020D
- Terminals: Matte Tin Finish annealed over Alloy 42 leadframe. Solderable per MIL-STD-202, Method 208
- Marking Information: See Page 2
- Ordering Information: See Page 2
- Weight: 0.004 grams (approximate)



Top View

## Maximum Ratings @T<sub>A</sub> = 25°C unless otherwise specified

Single phase, half wave, 60Hz, resistive or inductive load.  
For capacitance load, derate current by 20%.

Characteristic	Symbol	Value	Unit
Peak Repetitive Reverse Voltage	V <sub>RRM</sub>	30	V
Working Peak Reverse Voltage	V <sub>RWM</sub>		
DC Blocking Voltage	V <sub>RM</sub>		
RMS Reverse Voltage	V <sub>R(RMS)</sub>	21	V
Average Rectified Output Current T <sub>C</sub> =65°C	I <sub>O</sub>	1	A
Non-Repetitive Peak Forward Surge Current 8.3ms Single Half Sine-Wave Superimposed on Rated Load	I <sub>FSM</sub>	20	A

## Thermal Characteristics

Characteristic	Symbol	Value	Unit
Maximum Thermal Resistance	R <sub>θJA</sub>	488	°C/W
Thermal Resistance Junction to Ambient (Note 2)			
Operating and Storage Temperature Range	T <sub>J</sub> , T <sub>STG</sub>	-65 to +150	°C

## Electrical Characteristics @T<sub>A</sub> = 25°C unless otherwise specified

Characteristic	Symbol	Min	Typ	Max	Unit	Test Condition
Reverse Breakdown Voltage (Note 4)	V <sub>(BR)R</sub>	30	-	-	V	I <sub>R</sub> = 200μA
Forward Voltage Drop	V <sub>F</sub>	-	0.39	0.43	V	I <sub>F</sub> = 700mA, T <sub>J</sub> = 25°C
			0.31	0.34		I <sub>F</sub> = 700mA, T <sub>J</sub> = 150°C
			0.42	0.46		I <sub>F</sub> = 1A, T <sub>J</sub> = 25°C
			0.36	0.39		I <sub>F</sub> = 1A, T <sub>J</sub> = 150°C
Leakage Current (Note 4)	I <sub>R</sub>	-	8.0	20	μA	V <sub>R</sub> = 10V, T <sub>J</sub> = 25°C
			4.0	10	mA	V <sub>R</sub> = 10V, T <sub>J</sub> = 150°C
			12	50	μA	V <sub>R</sub> = 30V, T <sub>J</sub> = 25°C
			5	15	mA	V <sub>R</sub> = 30V, T <sub>J</sub> = 150°C

- Notes:
1. RoHS revision 13.2.2003. High temperature solder exemption applied, see *EU Directive Annex Note 7*.
  2. FR-4 PCB, 2 oz. Copper, minimum recommended pad layout per <http://www.diodes.com/datasheets/ap02001.pdf>.
  3. Diodes Inc.'s “Green” policy can be found on our website at [http://www.diodes.com/products/lead\\_free/index.php](http://www.diodes.com/products/lead_free/index.php).
  4. Short duration pulse test used to minimize self-heating effect.

SBR is a registered trademark of Diodes Incorporated.

SBR130S3

Document number: DS31099 Rev. 5 - 2

1 of 3  
[www.diodes.com](http://www.diodes.com)

March 2008  
© Diodes Incorporated

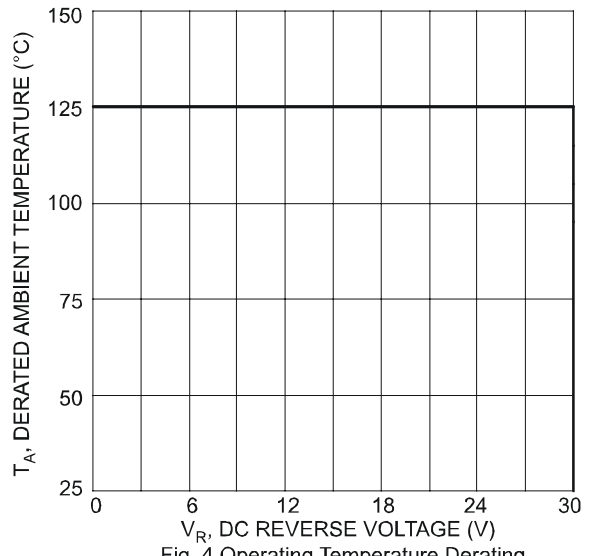
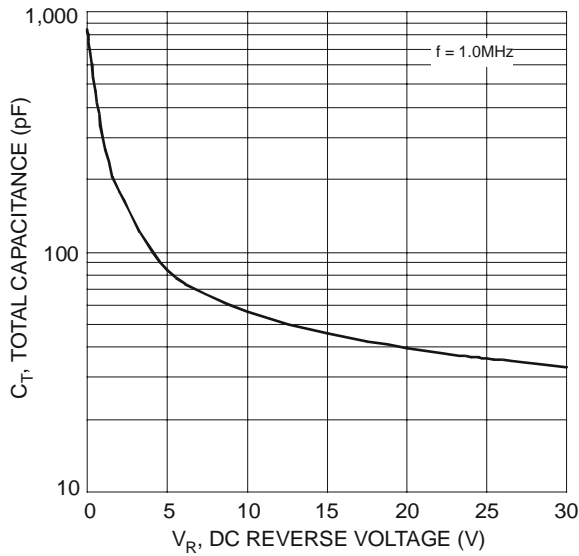
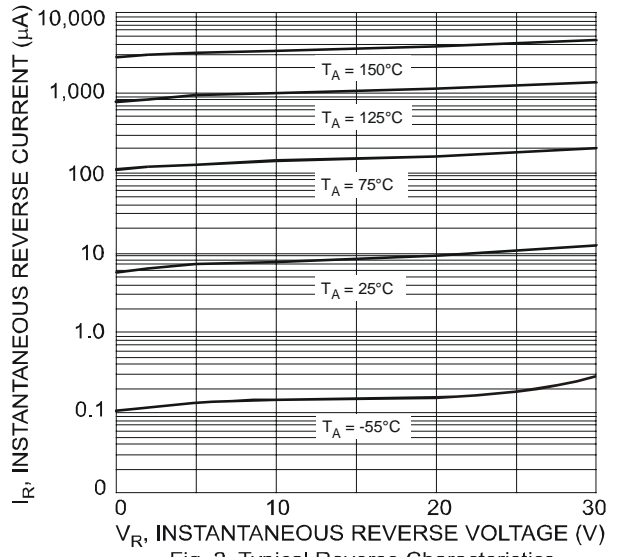
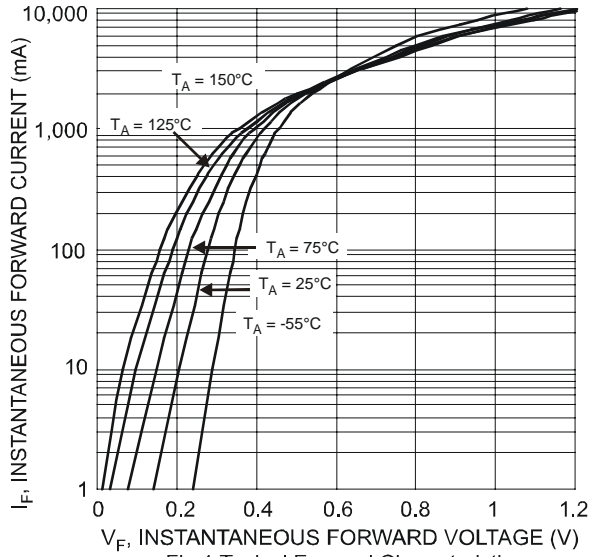

**Ordering Information** (Note 5)

Part Number	Case	Packaging
SBR130S3-7	SOD-323	3000/Tape & Reel

Notes: 5. For packaging details, go to our website at <http://www.diodes.com/datasheets/ap02007.pdf>.

**Marking Information**

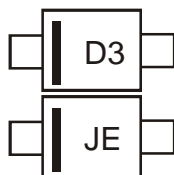

D3, JE = Product Type Marking Code

SBR is a registered trademark of Diodes Incorporated.

**Package Outline Dimensions**

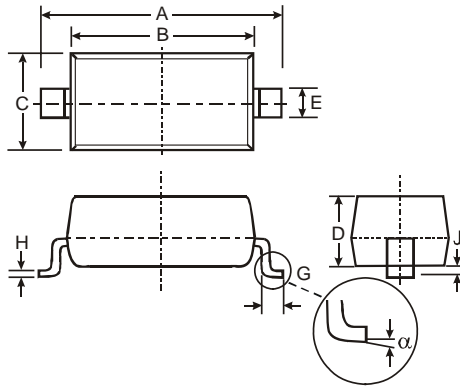

SOD-323		
Dim	Min	Max
A	2.30	2.70
B	1.60	1.80
C	1.20	1.40
D	1.05 Typical	
E	0.25	0.35
G	0.20	0.40
H	0.10	0.15
J	0.00	0.10
α	0°	8°
All Dimensions in mm		

**Suggested Pad Layout**

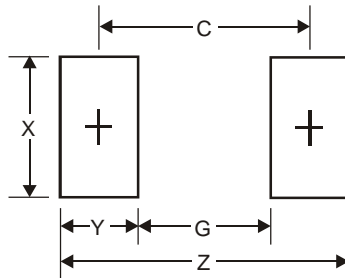

Dimensions	Value (in mm)
Z	3.75
G	1.05
X	0.65
Y	1.35
C	2.40

**IMPORTANT NOTICE**

Diodes Incorporated and its subsidiaries reserve the right to make modifications, enhancements, improvements, corrections or other changes without further notice to any product herein. Diodes Incorporated does not assume any liability arising out of the application or use of any product described herein; neither does it convey any license under its patent rights, nor the rights of others. The user of products in such applications shall assume all risks of such use and will agree to hold Diodes Incorporated and all the companies whose products are represented on our website, harmless against all damages.

**LIFE SUPPORT**

Diodes Incorporated products are not authorized for use as critical components in life support devices or systems without the expressed written approval of the President of Diodes Incorporated.