

2.5V CMOS Low-Jitter 62.5 MHz SAS-2 XO

FDSAS2062



5.0 x 3.2mm Ceramic SMD

ASSP XO™ for Storage



Product Features

- Very low phase jitter - 0.5ps RMS
- Thicker crystal for improved reliability
- Low output current - 15mA max.
- Low power stand by mode
- Industrial Temperature Range
- Pb-free & RoHS compliant

Product Description

This is an enhanced high-frequency 3.3V, 62.5MHz crystal clock oscillator with superb jitter and low operating current for Serial Attached SCSI (SAS-1 & SAS-2) applications. The output clock signal, generated internally with a patented oscillator design, is compatible with LVCMOS logic levels.

Applications

- SAS-2 Hard Disk Drive

Package:

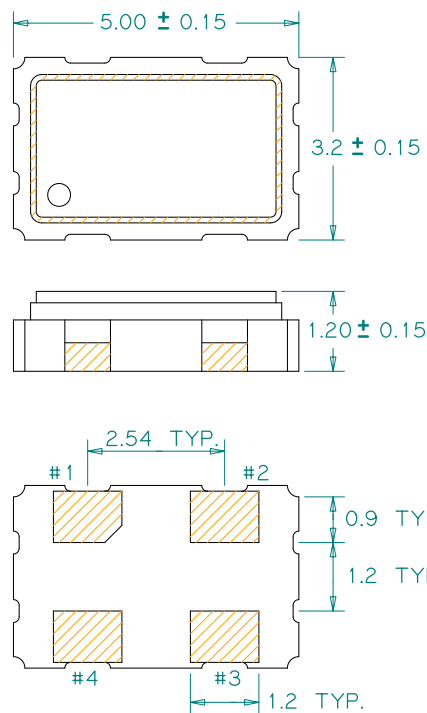

Recommended Land Pattern:

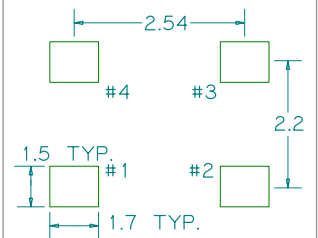

Pin Functions:

Pin	Function
1	OE Function
2	Ground
3	Clock Output
4	V _{DD}

*Extended high frequency power decoupling is recommended (see test circuit for minimum recommendation). To ensure optimal performance, do not route RF traces beneath the package.

Part Ordering Information: FDSAS2062

Electrical Performance

Parameter	Min.	Typ.	Max.	Units	Notes
Output Frequency		62.5		MHz	
Supply Voltage	2.375	2.5	2.625	V	
Supply Current, Output Enabled			15	mA	
Supply Current, Output Disabled			10	μA	
Frequency Stability			±50	ppm	See Note 1 below
Operating Temperature Range	-20		+70	°C	
Output Logic 0, V _{OL}			10% V _{DD}	V	
Output Logic 1, V _{OH}	90% V _{DD}			V	
Output Load			15	pF	
Duty Cycle	45		55	%	Measured 50% V _{DD}
Rise and Fall Time			2	ns	Measured 20/80% of waveform
Jitter, Phase RMS (1-σ)		0.2	0.5	ps	12kHz to 20 MHz frequency band
Jitter, pk-pk		21	30	ps	100.000 random periods

Notes:

- Stability includes all combinations of operating temperature, load changes, rated input (supply) voltage changes, initial calibration tolerance (25°C), aging (1 year at 25°C average effective ambient temperature), shock and vibration.
- For specifications other than those listed, please contact sales.

Output Enable / Disable Function

Parameter	Min.	Typ.	Max.	Units	Notes
Input Voltage (pin 1), Output Enable	0.7 V _{DD}			V	or open
Input Voltage (pin 1), Output Disable (low power standby)			0.3 V _{DD}	V	Output is Hi-Z
Internal Pullup Resistance	30			kΩ	
Output Disable Delay			200	ns	
Output Enable Delay			2	ms	

Absolute Maximum Ratings

Parameter	Min.	Typ.	Max.	Units	Notes
Storage Temperature	-55		+125	°C	

For the latest product information visit: <http://www.pericom.com/products/timing/oscillators/FDSAS2062/>

For test circuit go to: http://www.pericom.com/pdf/sre/tc_hcmos.pdf

For soldering reflow profile and reliability test ratings go to: <http://www.pericom.com/pdf/sre/reflow.pdf>

For typical phase noise go to: http://www.pericom.com/pdf/sre/pn_FDSAS2062.pdf

For tape and reel information go to: http://www.pericom.com/pdf/sre/tr_5032_xo.pdf