



**HIGH EFFICIENCY FAST RECOVERY RECTIFIER DIODES**

**FEATURES**

- SUITED FOR SMPS
- VERY LOW FORWARD LOSSES
- NEGLIGIBLE SWITCHING LOSSES
- HIGH SURGE CURRENT CAPABILITY
- HIGH AVALANCHE ENERGY CAPABILITY
- INSULATED VERSION TOP3I :  
Insulating voltage = 2500 V DC  
Capacitance = 12 pF

**DESCRIPTION**

Dual center tap rectifier suited for switchmode power supply and high frequency DC to DC converters.  
Packaged in SOT93, or TOP3I this device is intended for use in low voltage, high frequency inverters, free wheeling and polarity protection applications.

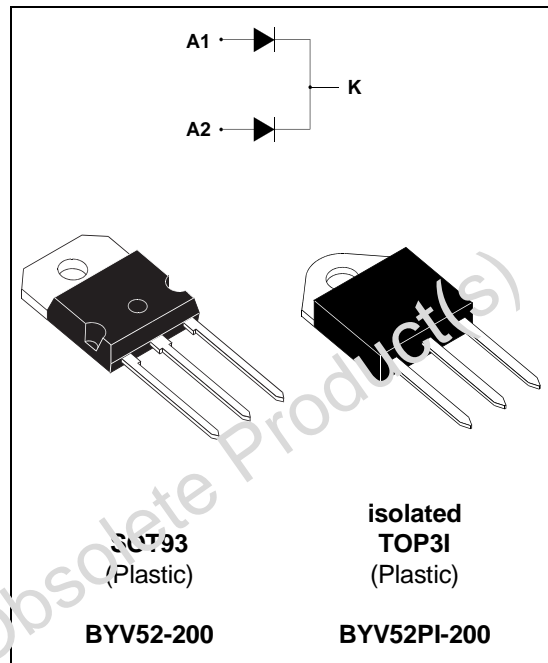

**ABSOLUTE MAXIMUM RATINGS**

Symbol	Parameter			Value	Unit
$I_{F(RMS)}$	RMS forward current			Per diode	50 A
$I_{F(AV)}$	Average forward current $\delta = 0.5$	SOT93	$T_c = 110^\circ\text{C}$	Per diode	30 A
		TOP3I	$T_c = 90^\circ\text{C}$	Per diode	30 A
$I_{FSM}$	Surge non repetitive forward current		$t_p = 10\text{ms}$ sinusoidal	Per diode	500 A
$T_{stg}$ $T_j$	Storage and junction temperature range			- 40 to + 150 - 40 to + 150	$^\circ\text{C}$ $^\circ\text{C}$

Symbol	Parameter	Value	Unit
$V_{RRM}$	Repetitive peak reverse voltage	200	V

## BYV52/PI

### THERMAL RESISTANCE

Symbol	Parameter		Value	Unit	
Rth (j-c)	Junction to case	SOT93	Per diode	1.2	°C/W
			Total	0.75	
		TOP3I	Per diode	1.8	
			Total	1.2	
Rth (c)	Coupling	SOT93	0.3	°C/W	
		TOP3I	0.6		

When the diodes 1 and 2 are used simultaneously :  
 $T_j - T_c (\text{diode } 1) = P(\text{diode } 1) \times R_{th(j-c)}(\text{Per diode}) + P(\text{diode } 2) \times R_{th(c)}$

### ELECTRICAL CHARACTERISTICS (Per diode) STATIC CHARACTERISTICS

Symbol	Test Conditions		Min.	Typ.	Max.	Unit
I <sub>R</sub> *	T <sub>j</sub> = 25°C	V <sub>R</sub> = V <sub>RRM</sub>			25	μA
	T <sub>j</sub> = 100°C				2.5	mA
V <sub>F</sub> **	T <sub>j</sub> = 125°C	I <sub>F</sub> = 20 A			0.85	V
	T <sub>j</sub> = 125°C	I <sub>F</sub> = 40 A			1.00	
	T <sub>j</sub> = 25°C	I <sub>F</sub> = 40 A			1.15	

Pulse test : \* tp = 5 ms, duty cycle < 2 %

\*\* tp = 380 μs, duty cycle < 2 %

To evaluate the conduction losses use the following equation :  
 $P = 0.7 \times I_{F(AV)} + 0.0075 \times I_F^2(\text{RMS})$

### RECOVERY CHARACTERISTICS

Symbol	Test Conditions		Min.	Typ.	Max.	Unit
trr	T <sub>j</sub> = 25°C	I <sub>F</sub> = 0.5A I <sub>R</sub> = 1A			35	ns
		I <sub>F</sub> = 1A V <sub>R</sub> = 30V			50	
tfr	T <sub>j</sub> = 25°C	I <sub>F</sub> = 1A V <sub>FR</sub> = 1.1 x V <sub>F</sub>		10		ns
V <sub>FP</sub>	T <sub>j</sub> = 25°C	I <sub>F</sub> = 1A		1.5		V

**Fig.1 :** Average forward power dissipation versus average forward current.

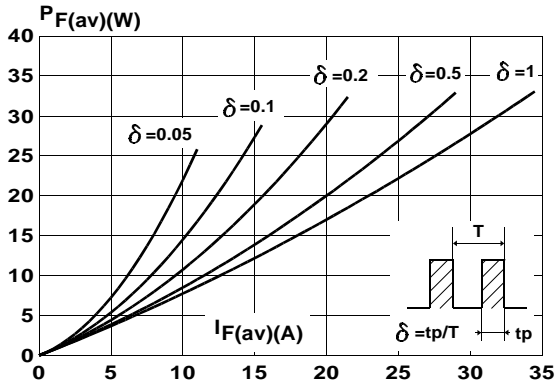

**Fig.2 :** Peak current versus form factor.

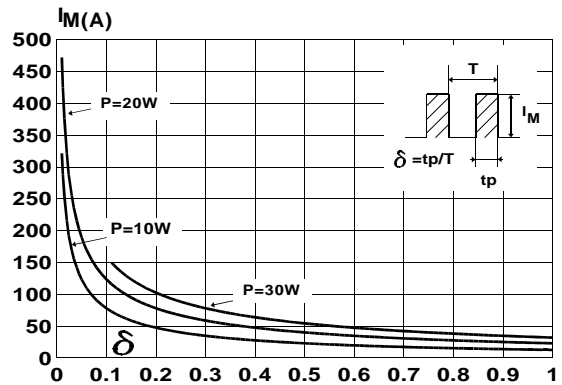

**Fig.3 :** Forward voltage drop versus forward current (maximum values).

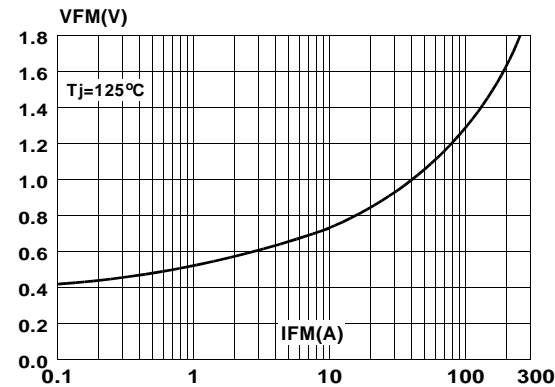

**Fig.4 :** Relative variation of thermal impedance junction to case versus pulse duration.

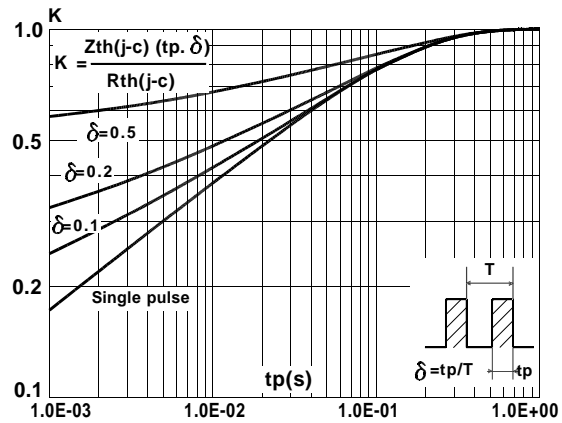

**Fig.5 :** Non repetitive surge peak forward current versus overload duration. (SOD93)

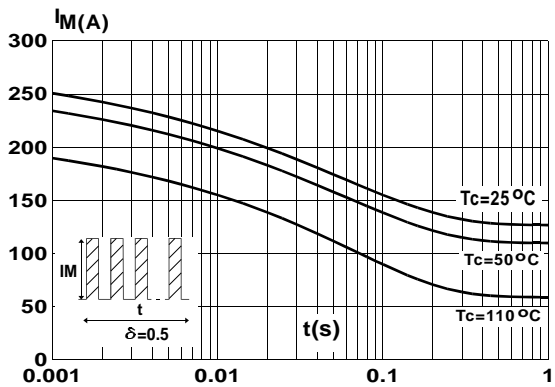

**Fig.6 :** Non repetitive surge peak forward current versus overload duration. (TOP3I)

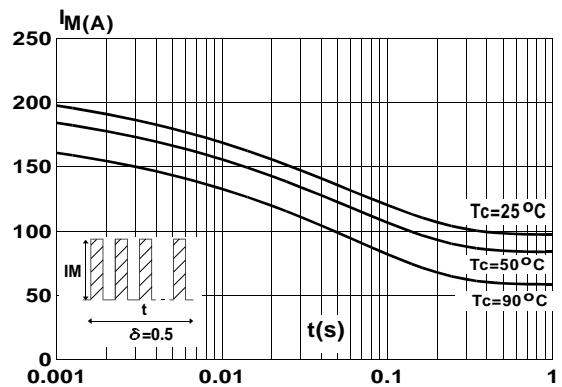

**Fig.7** : Average current versus ambient temperature.  
(duty cycle : 0.5) (SOD93)

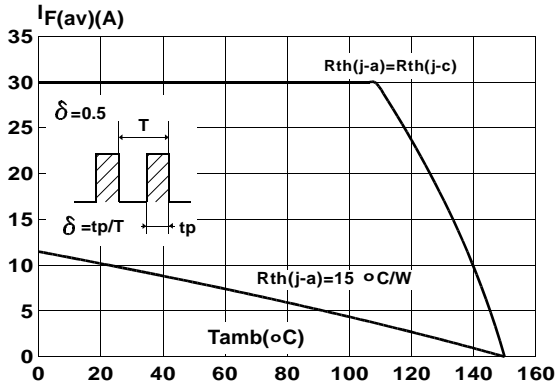

**Fig.8** : Average current versus ambient temperature.  
(duty cycle : 0.5) (TOP3I)

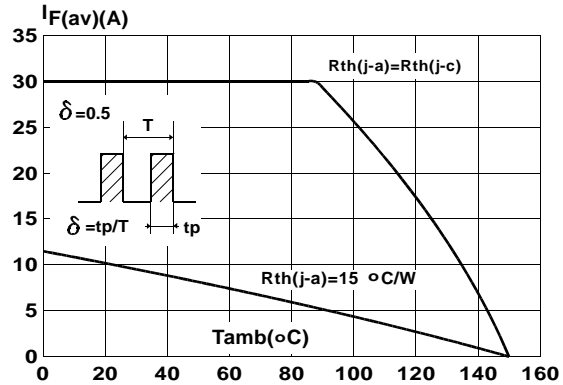

**Fig.9** : Junction capacitance versus reverse voltage applied (Typical values).

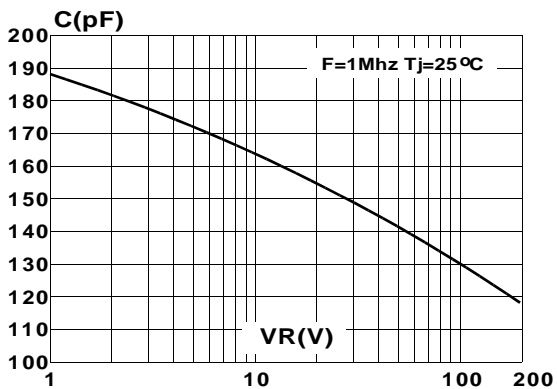

**Fig.10** : Recovery charges versus  $dI_F/dt$ .

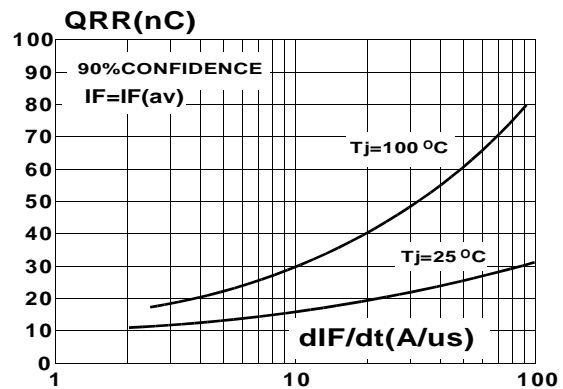

**Fig.11** : Peak reverse current versus  $dI_F/dt$ .

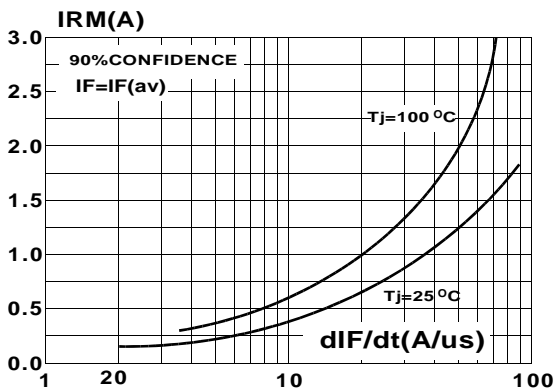

**Fig.12** : Dynamic parameters versus junction temperature.

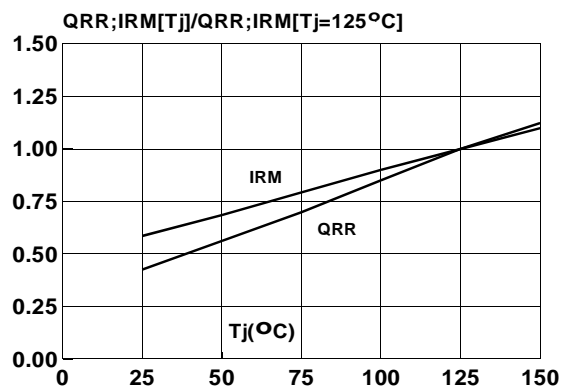

**PACKAGE MECHANICAL DATA**  
SOD93

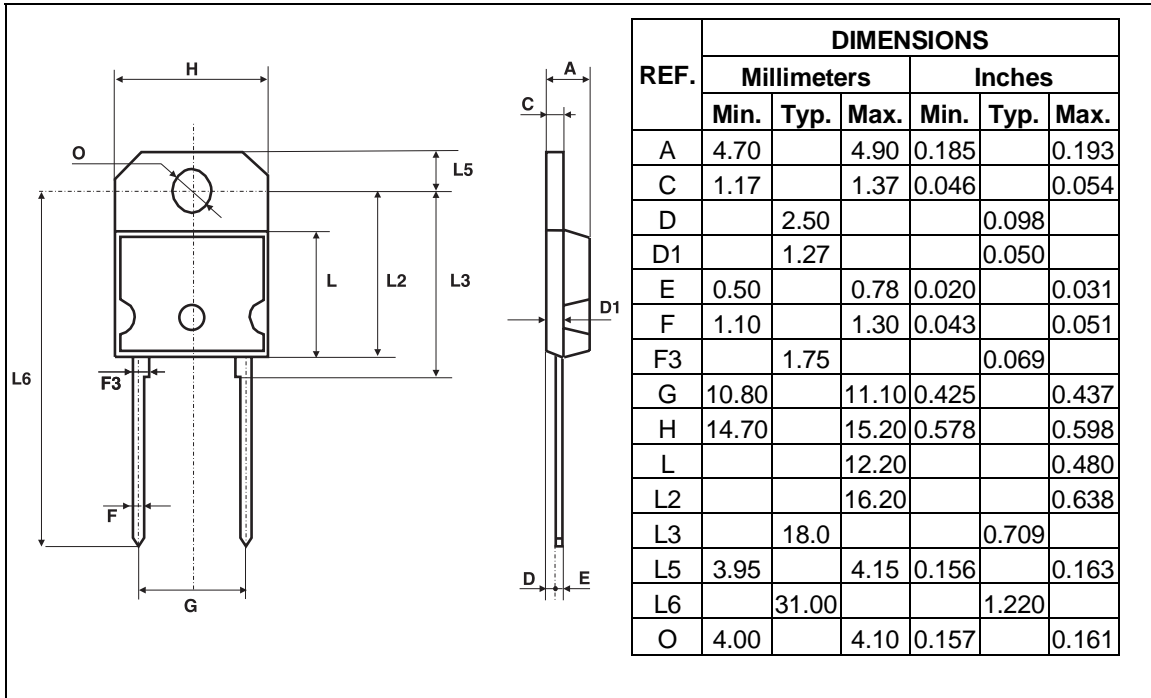

- **Marking** : Type number
- **Cooling method** : C
- **Weight** : 3.79 g
- **Recommended torque value** : 0.8m.N
- **Maximum torque value** : 1.0m.N

## BYV52/PI

### PACKAGE MECHANICAL DATA

TOP3I (isolated)

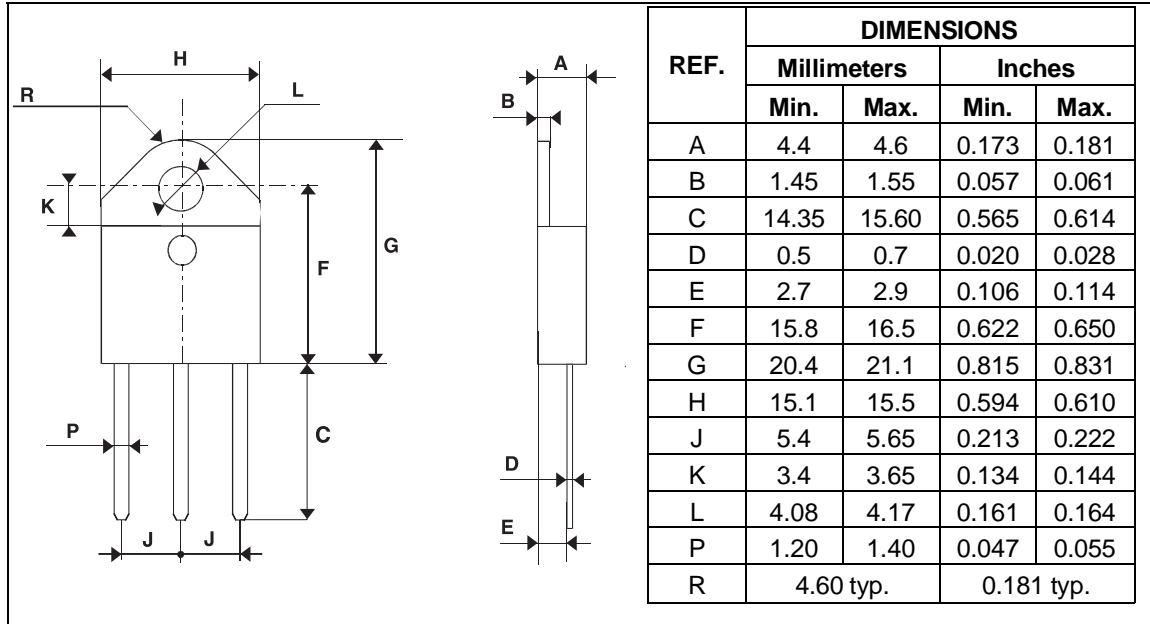

- **Marking** : Type number
- **Cooling method** : C
- **Weight** : 4.46 g
- **Recommended torque value** : 0.8m.N
- **Maximum torque value** : 1.0m.N

Information furnished is believed to be accurate and reliable. However, STMicroelectronics assumes no responsibility for the consequences of use of such information nor for any infringement of patents or other rights of third parties which may result from its use. No license is granted by implication or otherwise under any patent or patent rights of STMicroelectronics. Specifications mentioned in this publication are subject to change without notice. This publication supersedes and replaces all information previously supplied. STMicroelectronics products are not authorized for use as critical components in life support devices or systems without express written approval of STMicroelectronics.

The ST logo is a registered trademark of STMicroelectronics

© 1999 STMicroelectronics - Printed in Italy - All rights reserved.

STMicroelectronics GROUP OF COMPANIES

Australia - Brazil - China - Finland - France - Germany - Hong Kong - India - Italy - Japan - Malaysia  
Malta - Morocco - Singapore - Spain - Sweden - Switzerland - United Kingdom - U.S.A.

<http://www.st.com>