

# HiPerFRED<sup>2</sup>

High Performance Fast Recovery Diode  
Low Loss and Soft Recovery  
Common Cathode

$V_{RRM} = 300\text{ V}$   
 $I_{FAV} = 2 \times 30\text{ A}$   
 $t_{rr} = 35\text{ ns}$

Part number

**DPG 60 C 300 PC**

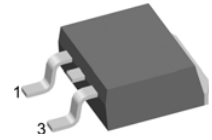
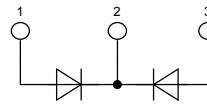

Backside: cathode

### Features / Advantages:

- Planar passivated chips
- Very low leakage current
- Very short recovery time
- Improved thermal behaviour
- Very low  $I_{RM}$ -values
- Very soft recovery behaviour
- Avalanche voltage rated for reliable operation
- Soft reverse recovery for low EMI/RFI
- Low  $I_{RM}$  reduces:
  - Power dissipation within the diode
  - Turn-on loss in the commutating switch

### Applications:

- Antiparallel diode for high frequency switching devices
- Antisaturation diode
- Snubber diode
- Free wheeling diode
- Rectifiers in switch mode power supplies (SMPS)
- Uninterruptible power supplies (UPS)

### Package:

- Housing: TO-263 (D2Pak)
- Industry standard outline
- Epoxy meets UL 94V-0
- RoHS compliant

Symbol	Definition	Conditions	Ratings			Unit
			min.	typ.	max.	
$V_{RRM}$	max. repetitive reverse voltage				300	V
$I_R$	reverse current	$V_R = 300\text{ V}$			1	$\mu\text{A}$
		$V_R = 300\text{ V}$			0.1	mA
$V_F$	forward voltage	$I_F = 30\text{ A}$			1.35	V
		$I_F = 60\text{ A}$			1.66	V
		$I_F = 30\text{ A}$			1.08	V
		$I_F = 60\text{ A}$			1.43	V
$I_{FAV}$	average forward current	rectangular d = 0.5			30	A
$V_{FO}$	threshold voltage	} for power loss calculation only			0.70	V
$r_F$	slope resistance				11.1	m $\Omega$
$R_{thJC}$	thermal resistance junction to case				0.85	K/W
$T_{VJ}$	virtual junction temperature		-55		175	$^{\circ}\text{C}$
$P_{tot}$	total power dissipation				175	W
$I_{FSM}$	max. forward surge current	t = 10 ms (50 Hz), sine			360	A
$I_{RM}$	max. reverse recovery current				3	A
		$I_F = 30\text{ A}; V_R = 200\text{ V}$			7	A
$t_{rr}$	reverse recovery time	-di <sub>F</sub> /dt = 200 A/ $\mu\text{s}$			35	ns
					55	ns
$C_J$	junction capacitance	$V_R = 150\text{ V}; f = 1\text{ MHz}$			50	pF

Symbol	Definition	Conditions	Ratings			Unit
			min.	typ.	max.	
$I_{RMS}$	RMS current	per pin <sup>1)</sup>			35	A
$R_{thCH}$	thermal resistance case to heatsink			0.25		K/W
$T_{stg}$	storage temperature		-55		150	°C
<b>Weight</b>				2		g
$F_c$	mounting force with clip		20		60	N

<sup>1)</sup>  $I_{RMS}$  is typically limited by: 1. pin-to-chip resistance; or by 2. current capability of the chip.  
In case of 1, a common cathode/anode configuration and a non-isolated backside, the whole current capability can be used by connecting the backside.

### Product Marking

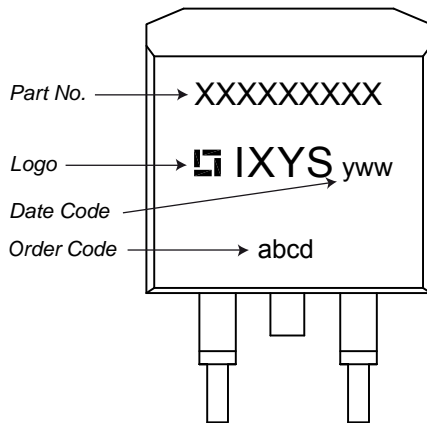

### Part number

D = Diode  
P = HiPerFRED  
G = extreme fast  
60 = Current Rating [A]  
C = Common Cathode  
300 = Reverse Voltage [V]  
PC = TO-263AB (D2Pak) (2)

Ordering	Part Name	Marking on Product	Delivering Mode	Base Qty	Code Key
Standard	DPG 60 C 300 PC	DPG60C300PC	Tape & Reel	800	503494

Similar Part	Package	Voltage Class
DPG60C300HB	TO-247AD (3)	300
DPG60C300QB	TO-3P (3)	300
DPG60C300HJ	ISOPLUS247 (3)	300
DPF60C300HB	TO-247AD (3)	300
DPG80C300HB	TO-247AD (3)	300

**Outlines TO-263 (D2Pak)**

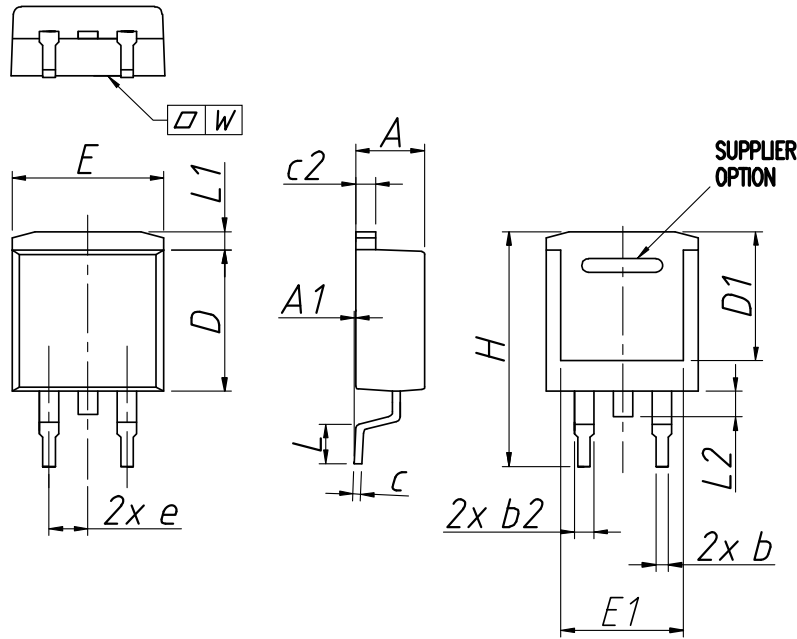

Dim.	Millimeter		Inches	
	min	max	min	max
A	4.06	4.83	0.160	0.190
A1	typ. 0.10		typ. 0.004	
b	0.51	0.99	0.020	0.039
b2	1.14	1.40	0.045	0.055
c	0.40	0.74	0.016	0.029
c2	1.14	1.40	0.045	0.029
D	8.38	9.40	0.330	0.370
D1	8.00	8.89	0.315	0.350
E	9.65	10.41	0.380	0.410
E1	6.22	8.20	0.245	0.323
e	2,54 BSC		0,100 BSC	
H	14.61	15.88	0.575	0.625
L	1.78	2.79	0.070	0.110
L1	1.02	1.68	0.040	0.066
L2	1.02	1.52	0.040	0.060
W	typ. 0.02	0.040	typ. 0.0008	0.0016

All dimensions conform with and/or are within JEDEC standard.

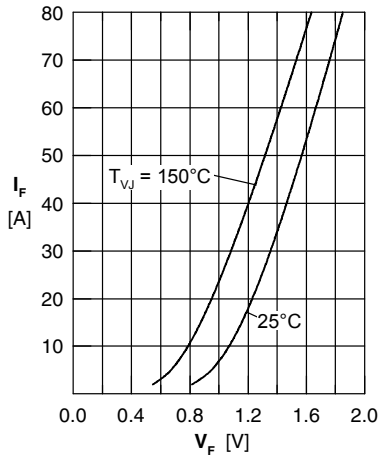

Fig. 1 Forward current  $I_F$  versus forward voltage  $V_F$

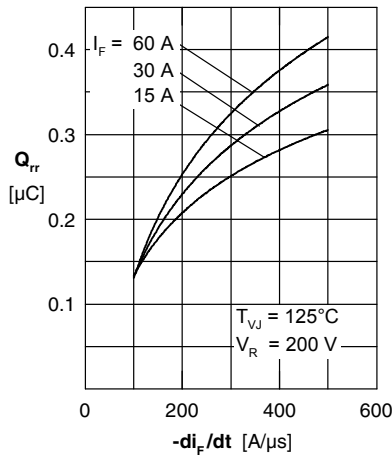

Fig. 2 Typ. reverse recovery charge  $Q_{rr}$  versus  $-di_F/dt$

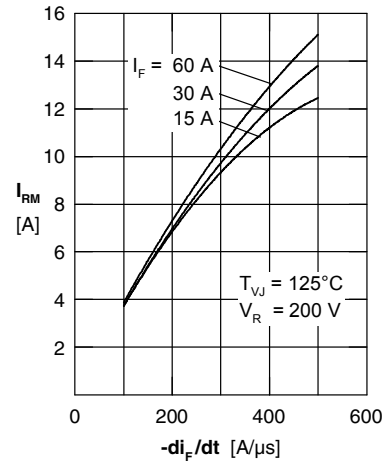

Fig. 3 Typ. reverse recovery current  $I_{RM}$  versus  $-di_F/dt$

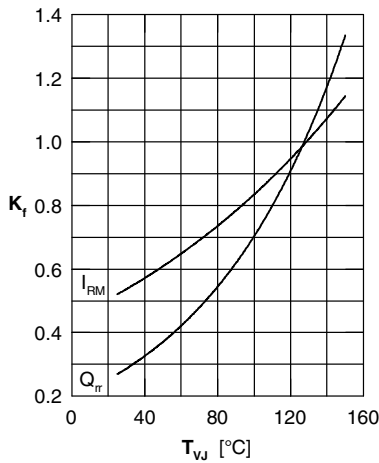

Fig. 4 Dynamic parameters  $Q_{rr}$ ,  $I_{RM}$  versus  $T_{VJ}$

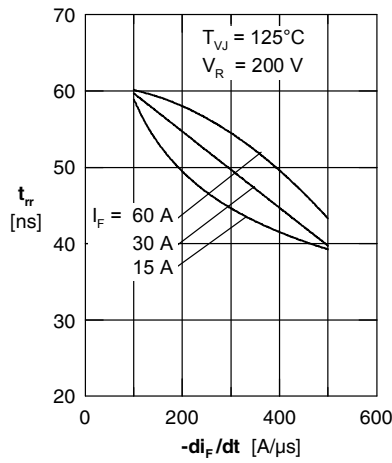

Fig. 5 Typ. reverse recovery time  $t_{rr}$  versus  $-di_F/dt$

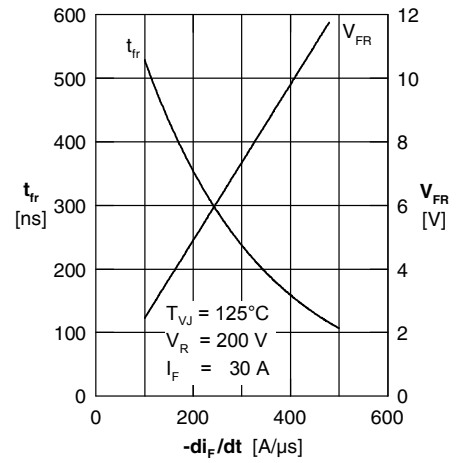

Fig. 6 Typ. forward recovery voltage  $V_{FR}$  & forward recovery time  $t_{fr}$  vs.  $di_F/dt$

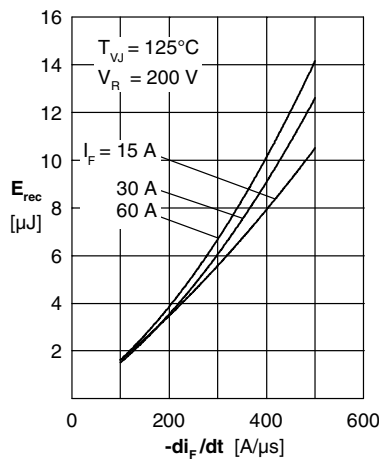

Fig. 7 Typ. recovery energy  $E_{rec}$  versus  $-di_F/dt$

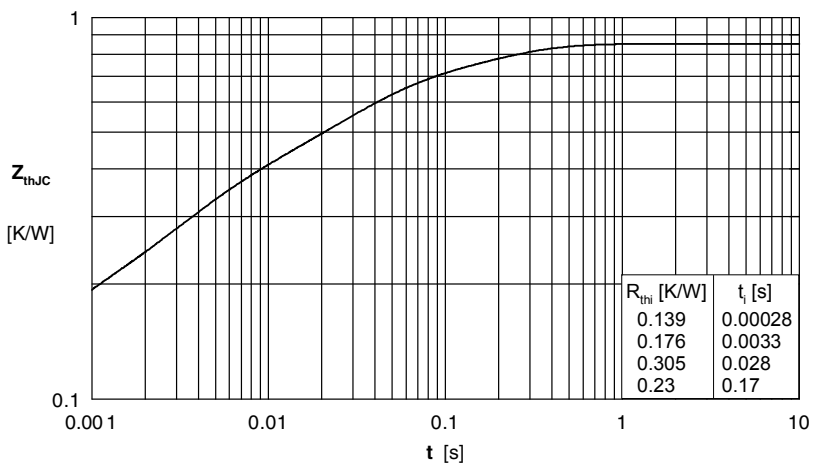

Fig. 8 Transient thermal impedance junction to case