

HiPerFRED²

High Performance Fast Recovery Diode
 Low Loss and Soft Recovery
 Common Cathode

$V_{RRM} = 400\text{ V}$
 $I_{FAV} = 2 \times 10\text{ A}$
 $t_{rr} = 45\text{ ns}$

Part number
DPG 20 C 400 PN

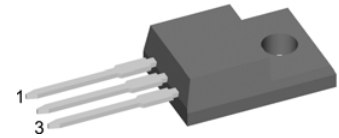
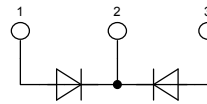

Backside: isolated

E72873

Features / Advantages:

- Planar passivated chips
- Very low leakage current
- Very short recovery time
- Improved thermal behaviour
- Very low I_{rm} -values
- Very soft recovery behaviour
- Avalanche voltage rated for reliable operation
- Soft reverse recovery for low EMI/RFI
- Low I_{rm} reduces:
 - Power dissipation within the diode
 - Turn-on loss in the commutating switch

Applications:

- Antiparallel diode for high frequency switching devices
- Antisaturation diode
- Snubber diode
- Free wheeling diode
- Rectifiers in switch mode power supplies (SMPS)
- Uninterruptible power supplies (UPS)

Package:

- Housing: TO-220FP
- Industry standard outline
- Plastic overmolded tab for electrical isolation
- Isolation Voltage 2500 V
- Epoxy meets UL 94V-0
- RoHS compliant

Symbol	Definition	Conditions	Ratings			Unit
			min.	typ.	max.	
V_{RRM}	max. repetitive reverse voltage				400	V
I_R	reverse current	$V_R = 400\text{ V}$			1	μA
		$V_R = 400\text{ V}$			0.15	mA
V_F	forward voltage	$I_F = 10\text{ A}$			1.32	V
		$I_F = 20\text{ A}$			1.51	V
		$I_F = 10\text{ A}$			1.03	V
		$I_F = 20\text{ A}$			1.24	V
I_{FAV}	average forward current	rectangular d = 0.5			10	A
V_{FO}	threshold voltage	} for power loss calculation only			0.77	V
r_F	slope resistance				19.8	m Ω
R_{thJC}	thermal resistance junction to case				4.40	K/W
T_{VJ}	virtual junction temperature		-55		175	$^{\circ}\text{C}$
P_{tot}	total power dissipation				35	W
I_{FSM}	max. forward surge current	t = 10 ms (50 Hz), sine			150	A
I_{RM}	max. reverse recovery current				4	A
		$I_F = 10\text{ A}; V_R = 270\text{ V}$			6	A
t_{rr}	reverse recovery time	-di _F /dt = 200 A/ μs			45	ns
					65	ns
C_J	junction capacitance	$V_R = 200\text{ V}; f = 1\text{ MHz}$			12	pF

Symbol	Definition	Conditions	Ratings			Unit
			min.	typ.	max.	
I_{RMS}	RMS current	per pin ¹⁾			35	A
R_{thCH}	thermal resistance case to heatsink			0.50		K/W
T_{stg}	storage temperature		-55		150	°C
Weight				2		g
M_D	mounting torque		0.4		0.6	Nm
F_C	mounting force with clip		20		60	N
V_{ISOL}	isolation voltage	t = 1 second	2500			V
		t = 1 minute	2000			V
d_s	creepage distance on surface		1.07			mm
d_A	striking distance through air		1.07			mm

¹⁾ I_{RMS} is typically limited by: 1. pin-to-chip resistance; or by 2. current capability of the chip.
 In case of 1, a common cathode/anode configuration and a non-isolated backside, the whole current capability can be used by connecting the backside.

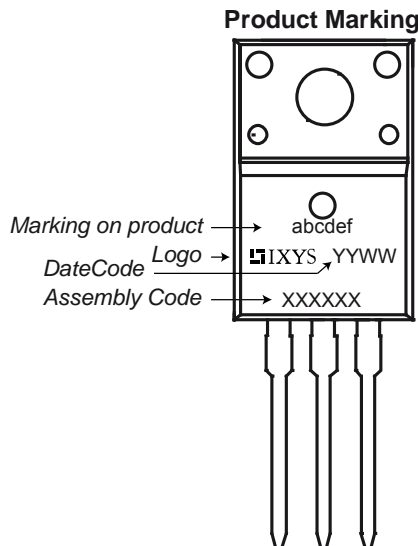

Part number

D = Diode
 P = HiPerFRED
 G = extreme fast
 20 = Current Rating [A]
 C = Common Cathode
 400 = Reverse Voltage [V]
 PN = TO-220ABFP (3)

Ordering	Part Name	Marking on Product	Delivering Mode	Base Qty	Code Key
Standard	DPG 20 C 400 PN	DPG20C400PN	Tube	50	504338

Similar Part	Package	Voltage Class
DPG20C400PB	TO-220AB (3)	400
DPG20C400PC	TO-263AB (D2Pak)	400

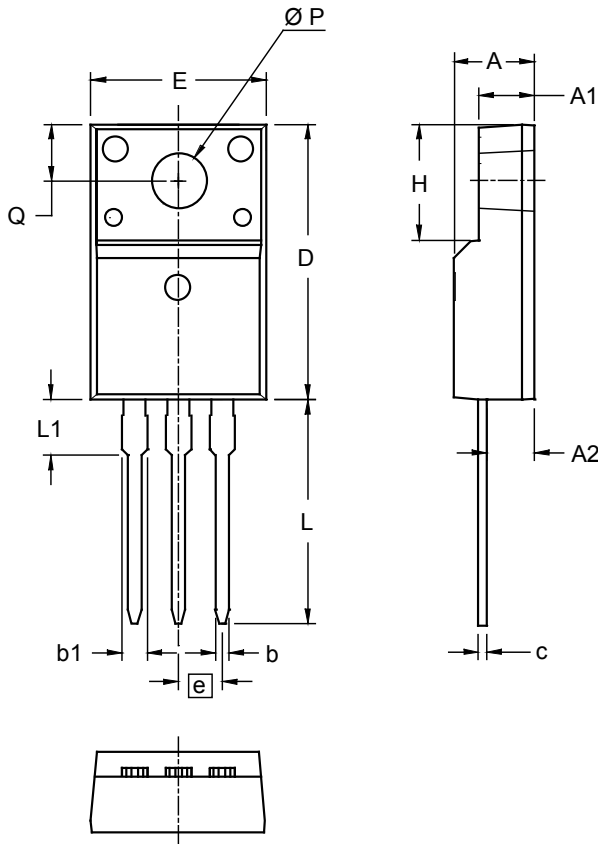
Outlines TO-220FP



SYM	INCHES		MILLIMETERS	
	MIN	MAX	MIN	MAX
A	.177	.193	4.50	4.90
A1	.092	.108	2.34	2.74
A2	.101	.117	2.56	2.96
b	.028	.035	0.70	0.90
b1	.050	.058	1.27	1.47
c	.018	.024	0.45	0.60
D	.617	.633	15.67	16.07
E	.392	.408	9.96	10.36
e	.100 BSC		2.54 BSC	
H	.255	.271	6.48	6.88
L	.499	.523	12.68	13.28
L1	.119	.135	3.03	3.43
ØP	.121	.129	3.08	3.28
Q	.126	.134	3.20	3.40

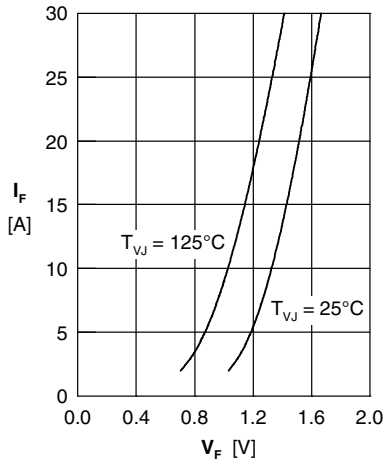

Fig. 1 Forward current I_F versus forward voltage drop V_F

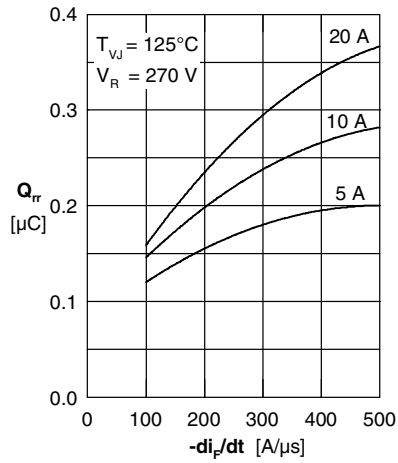

Fig. 2 Typ. reverse recovery charge Q_{rr} versus $-di_F/dt$

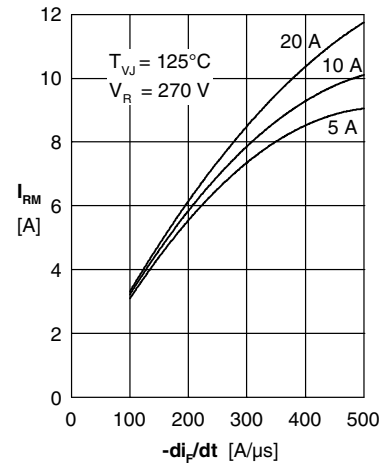

Fig. 3 Typ. reverse recovery current I_{RM} versus $-di_F/dt$

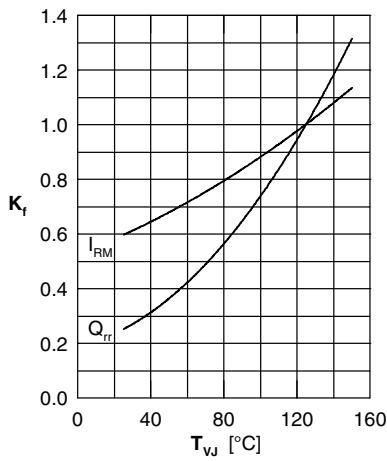

Fig. 4 Dynamic parameters Q_{rr} , I_{RM} versus T_{VJ}

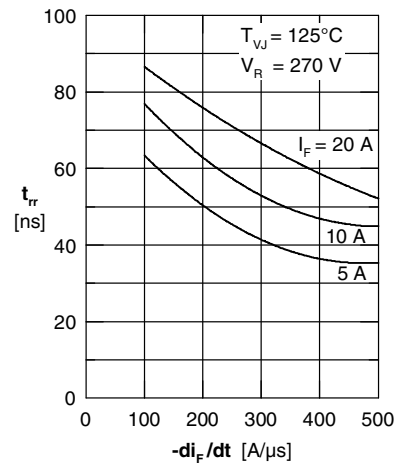

Fig. 5 Typ. reverse recovery time t_{rr} versus $-di_F/dt$

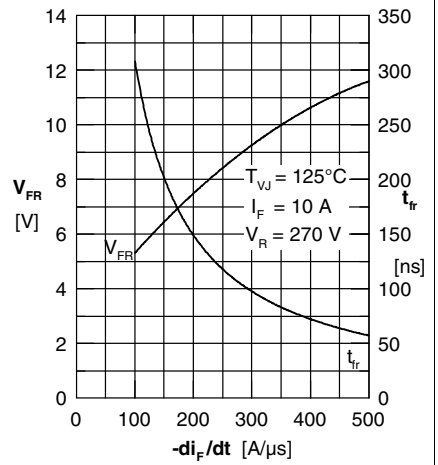

Fig. 6 Typ. forward recovery voltage V_{FR} and t_{fr} versus di_F/dt

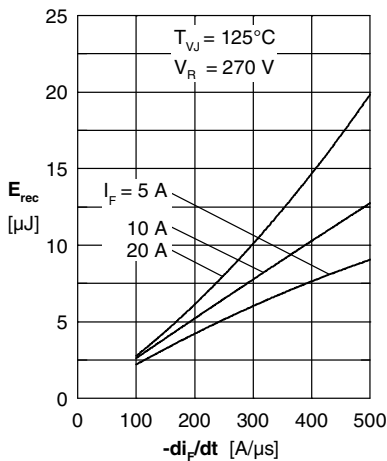

Fig. 7 Typ. recovery energy E_{rec} versus $-di_F/dt$

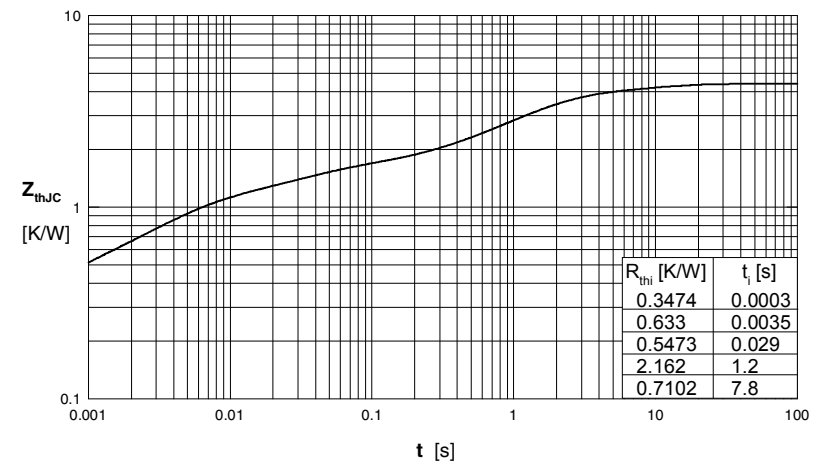

Fig. 8 Transient thermal resistance junction to case