

MBRB30H60CT-1G, MBR30H60CTG, MBRF30H60CTG, MBRB30H60CTT4G

SWITCHMODE™ Power Rectifier 60 V, 30 A

Features and Benefits

- Low Forward Voltage
- Low Power Loss/High Efficiency
- High Surge Capacity
- 175°C Operating Junction Temperature
- 30 A Total (15 A Per Diode Leg)
- Guard-Ring for Stress Protection
- These are Pb-Free Devices

Applications

- Power Supply – Output Rectification
- Power Management
- Instrumentation

Mechanical Characteristics:

- Case: Epoxy, Molded
- Epoxy Meets UL 94 V-0 @ 0.125 in
- Weight (Approximately): 1.5 Grams (I²PAK)
1.7 Grams (D²PAK)
1.9 Grams (TO-220 and TO-220FP)
- Finish: All External Surfaces Corrosion Resistant and Terminal Leads are Readily Solderable
- Lead Temperature for Soldering Purposes:
260°C Max. for 10 Seconds

MAXIMUM RATINGS

Please See the Table on the Following Page



ON Semiconductor®

<http://onsemi.com>

SCHOTTKY BARRIER RECTIFIERS 30 AMPERES, 60 VOLTS

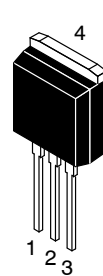
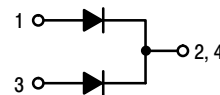

I²PAK (TO-262)
CASE 418D
PLASTIC
STYLE 3

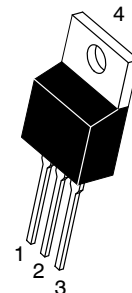

TO-220
CASE 221A
PLASTIC
STYLE 6

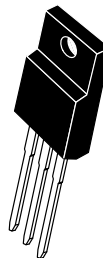

TO-220
CASE 221D
STYLE 3

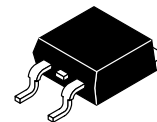

D²PAK
CASE 418B

ORDERING AND MARKING INFORMATION

See detailed ordering and shipping information in the package dimensions section on page 6 of this data sheet.

MBRB30H60CT-1G, MBR30H60CTG, MBRF30H60CTG, MBRB30H60CTT4G

MAXIMUM RATINGS (Per Diode Leg)

Rating	Symbol	Value	Unit
Peak Repetitive Reverse Voltage Working Peak Reverse Voltage DC Blocking Voltage	V_{RRM} V_{RWM} V_R	60	V
Average Rectified Forward Current (Rated V_R) $T_C = 159^\circ\text{C}$	$I_{F(AV)}$	15	A
Peak Repetitive Forward Current (Rated V_R , Square Wave, 20 kHz)	I_{FRM}	30	A
Nonrepetitive Peak Surge Current (Surge applied at rated load conditions halfwave, single phase, 60 Hz)	I_{FSM}	260	A
Operating Junction Temperature (Note 1)	T_J	-55 to +175	$^\circ\text{C}$
Storage Temperature	T_{stg}	-55 to +175	$^\circ\text{C}$
Voltage Rate of Change (Rated V_R)	dv/dt	10,000	V/ μs
Controlled Avalanche Energy (see test conditions in Figures 11 and 12)	W_{AVAIL}	350	mJ
ESD Ratings: Machine Model = C Human Body Model = 3B		> 400 > 8000	V

THERMAL CHARACTERISTICS

Maximum Thermal Resistance (MBRB30H60CT-1G and MBR30H60CTG) – Junction-to-Case – Junction-to-Ambient (MBRF30H60CTG) – Junction-to-Case (MBRB30H60CTTRG) – Junction-to-Case	$R_{\theta JC}$ $R_{\theta JA}$ $R_{\theta JC}$ $R_{\theta JC}$	2.0 70 4.4 1.6	$^\circ\text{C}/\text{W}$
--	--	-------------------------	---------------------------

ELECTRICAL CHARACTERISTICS (Per Diode Leg)

Maximum Instantaneous Forward Voltage (Note 2) ($I_F = 15\text{ A}$, $T_C = 25^\circ\text{C}$) ($I_F = 15\text{ A}$, $T_C = 125^\circ\text{C}$) ($I_F = 30\text{ A}$, $T_C = 25^\circ\text{C}$) ($I_F = 30\text{ A}$, $T_C = 125^\circ\text{C}$)	V_F	0.62 0.56 0.78 0.71	V
Maximum Instantaneous Reverse Current (Note 2) (Rated DC Voltage, $T_C = 25^\circ\text{C}$) (Rated DC Voltage, $T_C = 125^\circ\text{C}$)	i_R	0.3 45	mA

Stresses exceeding Maximum Ratings may damage the device. Maximum Ratings are stress ratings only. Functional operation above the Recommended Operating Conditions is not implied. Extended exposure to stresses above the Recommended Operating Conditions may affect device reliability.

1. The heat generated must be less than the thermal conductivity from Junction-to-Ambient: $dP_D/dT_J < 1/R_{\theta JA}$.
2. Pulse Test: Pulse Width = 300 μs , Duty Cycle $\leq 2.0\%$.

MBRB30H60CT-1G, MBR30H60CTG, MBRF30H60CTG, MBRB30H60CTT4G

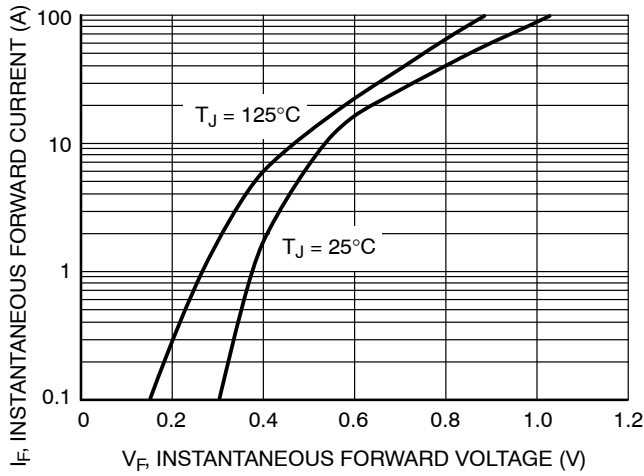

Figure 1. Typical Forward Voltage

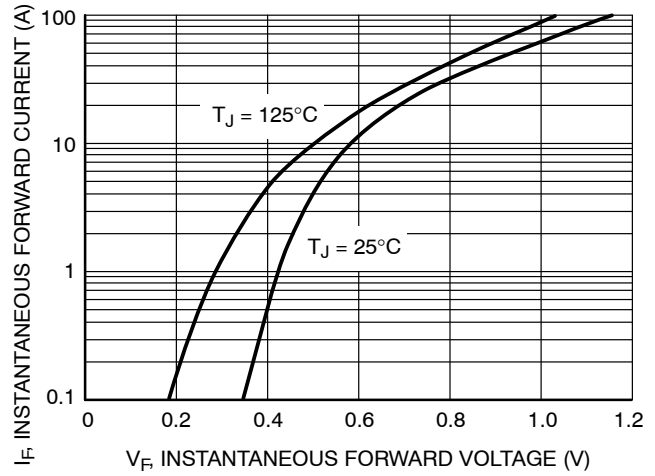

Figure 2. Maximum Forward Voltage

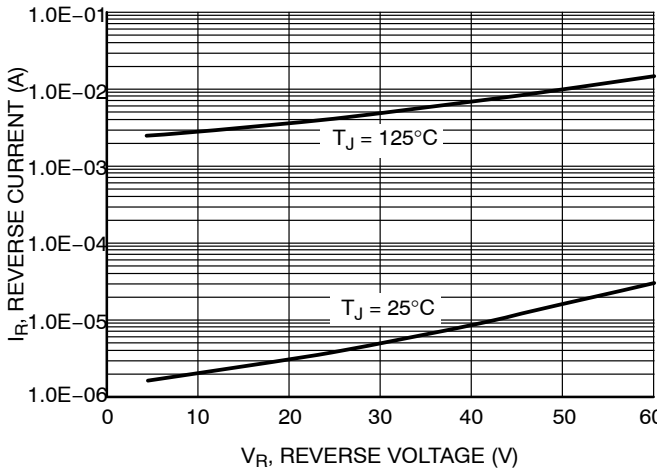

Figure 3. Typical Reverse Current

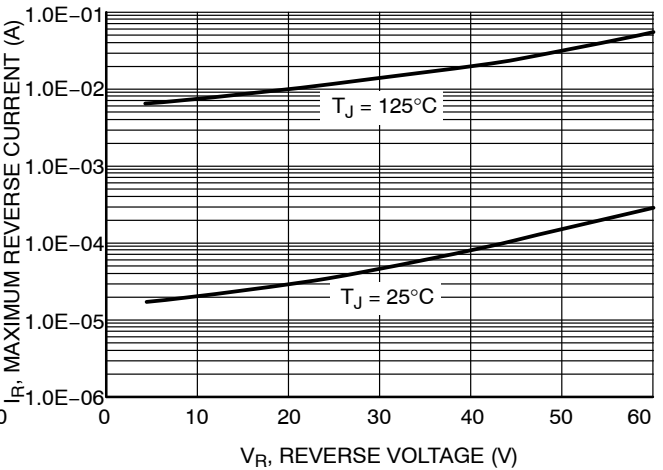

Figure 4. Maximum Reverse Current

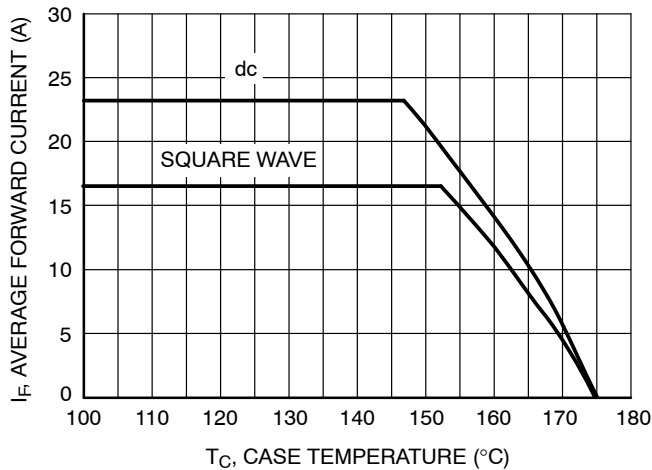

Figure 5. Current Derating for MBRB30H60CT-1G, MBR30H60CTG, and MBRB30H60CTT4G

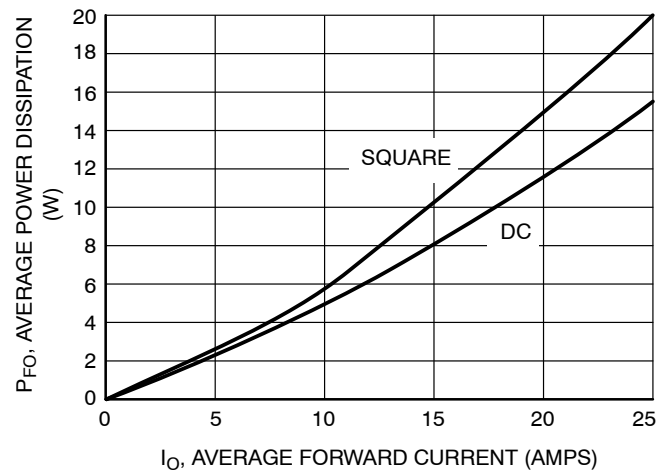

Figure 6. Forward Power Dissipation

MBRB30H60CT-1G, MBR30H60CTG, MBRF30H60CTG, MBRB30H60CTT4G

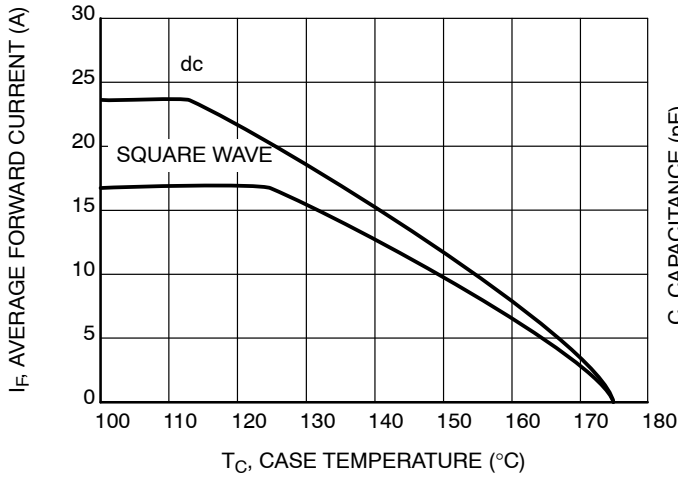

Figure 8. Current Derating for MBRF30H60CTG

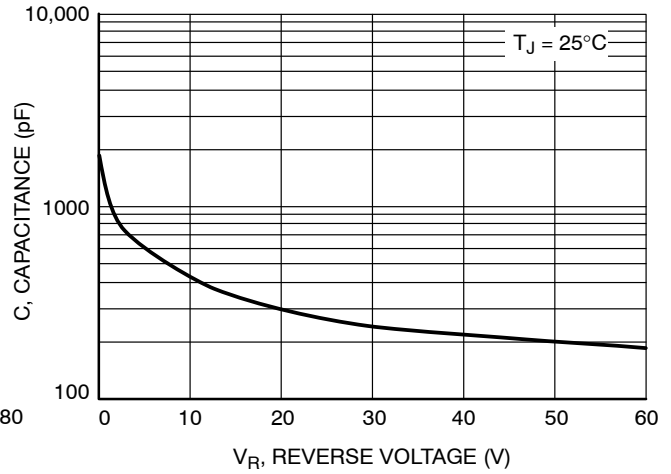

Figure 7. Capacitance

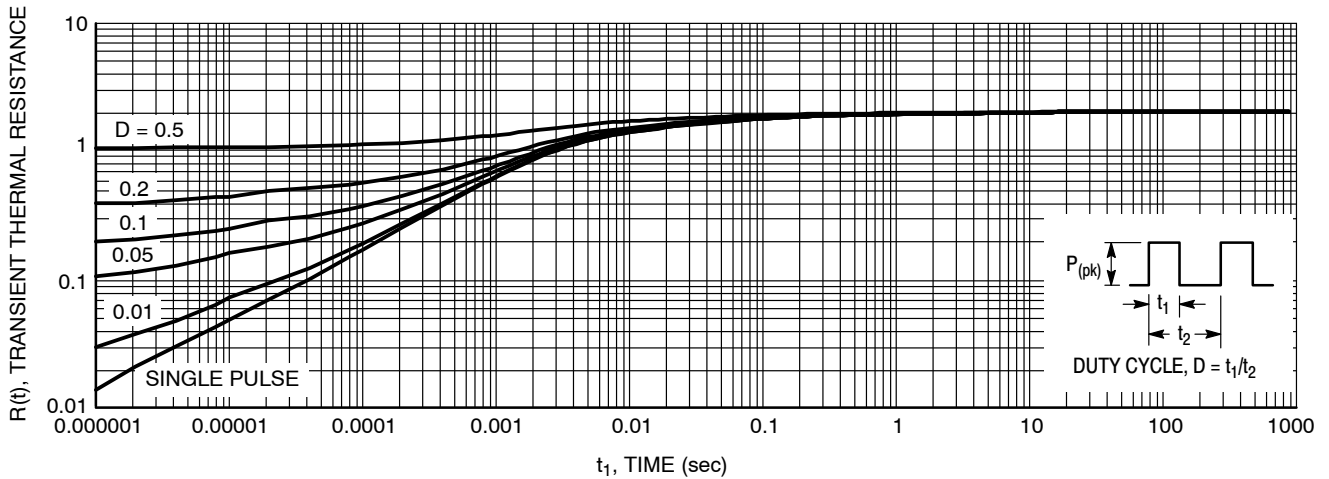

Figure 9. Thermal Response Junction-to-Case for MBRB30H60CT-1G, MBR30H60CTG and MBRB30H60CTT4G

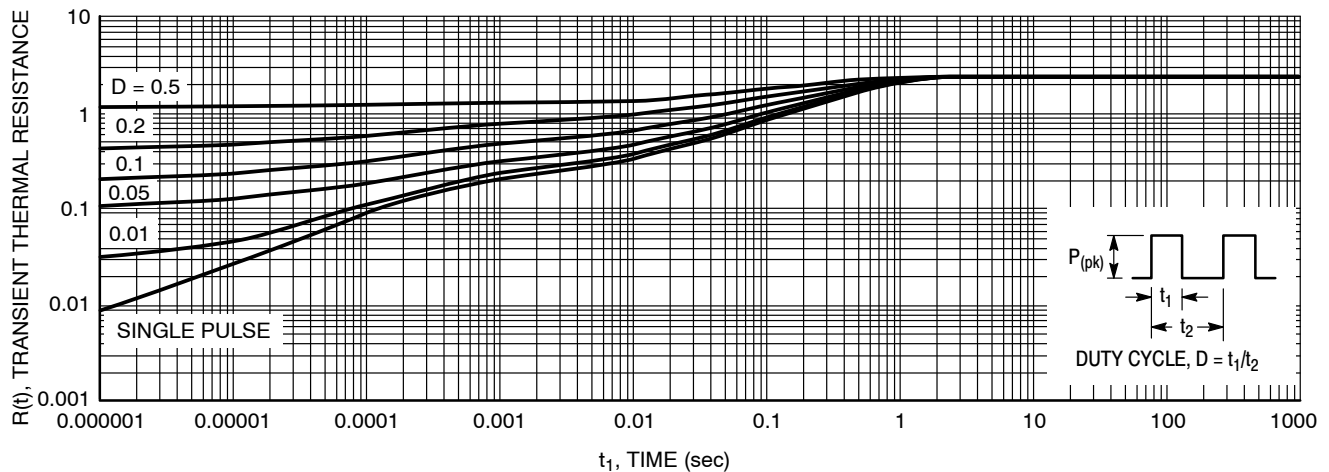

Figure 10. Thermal Response Junction-to-Case for MBRF30H60CTG

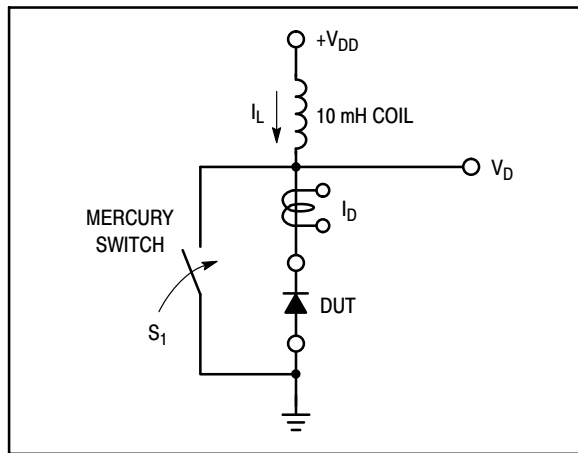

Figure 11. Test Circuit

The unclamped inductive switching circuit shown in Figure 11 was used to demonstrate the controlled avalanche capability of this device. A mercury switch was used instead of an electronic switch to simulate a noisy environment when the switch was being opened.

When S_1 is closed at t_0 the current in the inductor I_L ramps up linearly; and energy is stored in the coil. At t_1 the switch is opened and the voltage across the diode under test begins to rise rapidly, due to di/dt effects, when this induced voltage reaches the breakdown voltage of the diode, it is clamped at BV_{DUT} and the diode begins to conduct the full load current which now starts to decay linearly through the diode, and goes to zero at t_2 .

By solving the loop equation at the point in time when S_1 is opened; and calculating the energy that is transferred to the diode it can be shown that the total energy transferred is equal to the energy stored in the inductor plus a finite amount of energy from the V_{DD} power supply while the diode is in breakdown (from t_1 to t_2) minus any losses due to finite component resistances. Assuming the component resistive

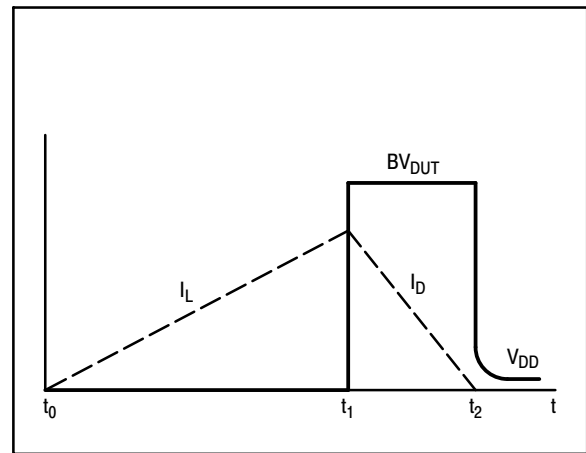

Figure 12. Current-Voltage Waveforms

elements are small Equation (1) approximates the total energy transferred to the diode. It can be seen from this equation that if the V_{DD} voltage is low compared to the breakdown voltage of the device, the amount of energy contributed by the supply during breakdown is small and the total energy can be assumed to be nearly equal to the energy stored in the coil during the time when S_1 was closed, Equation (2).

EQUATION (1):

$$W_{AVAL} \approx \frac{1}{2} L I_{LPK}^2 \left(\frac{BV_{DUT}}{BV_{DUT} - V_{DD}} \right)$$

EQUATION (2):

$$W_{AVAL} \approx \frac{1}{2} L I_{LPK}^2$$

MBRB30H60CT-1G, MBR30H60CTG, MBRF30H60CTG, MBRB30H60CTT4G

MARKING DIAGRAMS

I²PAK (TO-262)
CASE 418D



TO-220
CASE 221A

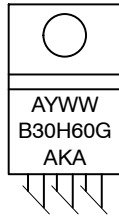

TO-220
CASE 221D



D²PAK
CASE 418B



B30H60 = Device Code
 A = Assembly Location
 Y = Year
 WW = Work Week
 G = Pb-Free Package
 AKA = Polarity Designator

ORDERING INFORMATION

Device	Package	Shipping [†]
MBRB30H60CT-1G	TO-262 (Pb-Free)	50 Units / Rail
MBR30H60CTG	TO-220 (Pb-Free)	50 Units / Rail
MBRF30H60CTG	TO-220FP (Pb-Free)	50 Units / Rail
MBRB30H60CTT4G	D ² PAK (Pb-Free)	800 / Tape & Reel

[†]For information on tape and reel specifications, including part orientation and tape sizes, please refer to our Tape and Reel Packaging Specifications Brochure, BRD8011/D.

PACKAGE DIMENSIONS

I²PAK (TO-262)
CASE 418D-01
ISSUE D

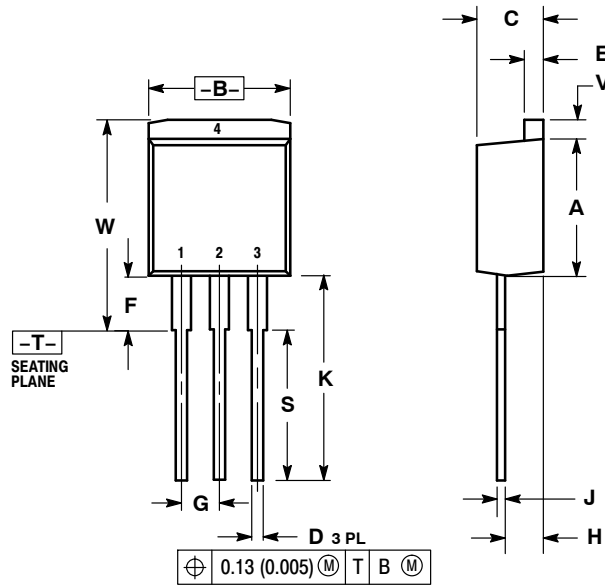

NOTES:
1. DIMENSIONING AND TOLERANCING PER ANSI Y14.5M, 1982.
2. CONTROLLING DIMENSION: INCH.

DIM	INCHES		MILLIMETERS	
	MIN	MAX	MIN	MAX
A	0.335	0.380	8.51	9.65
B	0.380	0.406	9.65	10.31
C	0.160	0.185	4.06	4.70
D	0.026	0.035	0.66	0.89
E	0.045	0.055	1.14	1.40
F	0.122 REF		3.10 REF	
G	0.100 BSC		2.54 BSC	
H	0.094	0.110	2.39	2.79
J	0.013	0.025	0.33	0.64
K	0.500	0.562	12.70	14.27
S	0.390 REF		9.90 REF	
V	0.045	0.070	1.14	1.78
W	0.522	0.551	13.25	14.00

STYLE 3:
PIN 1. ANODE
2. CATHODE
3. ANODE
4. CATHODE

TO-220
CASE 221A-09
ISSUE AF

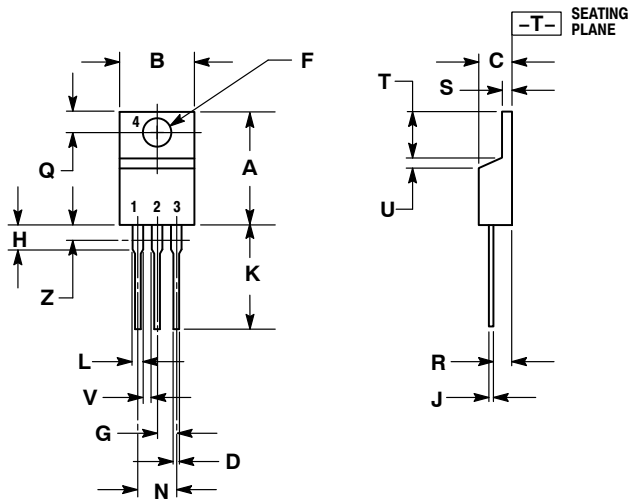

NOTES:
1. DIMENSIONING AND TOLERANCING PER ANSI Y14.5M, 1982.
2. CONTROLLING DIMENSION: INCH.
3. DIMENSION Z DEFINES A ZONE WHERE ALL BODY AND LEAD IRREGULARITIES ARE ALLOWED.

DIM	INCHES		MILLIMETERS	
	MIN	MAX	MIN	MAX
A	0.570	0.620	14.48	15.75
B	0.380	0.405	9.66	10.28
C	0.160	0.190	4.07	4.82
D	0.025	0.035	0.64	0.88
F	0.142	0.161	3.61	4.09
G	0.095	0.105	2.42	2.66
H	0.110	0.155	2.80	3.93
J	0.014	0.025	0.36	0.64
K	0.500	0.562	12.70	14.27
L	0.045	0.060	1.15	1.52
N	0.190	0.210	4.83	5.33
Q	0.100	0.120	2.54	3.04
R	0.080	0.110	2.04	2.79
S	0.045	0.055	1.15	1.39
T	0.235	0.255	5.97	6.47
U	0.000	0.050	0.00	1.27
V	0.045	---	1.15	---
Z	---	0.080	---	2.04

STYLE 6:
PIN 1. ANODE
2. CATHODE
3. ANODE
4. CATHODE

PACKAGE DIMENSIONS

D²PAK 3
CASE 418B-04
ISSUE K

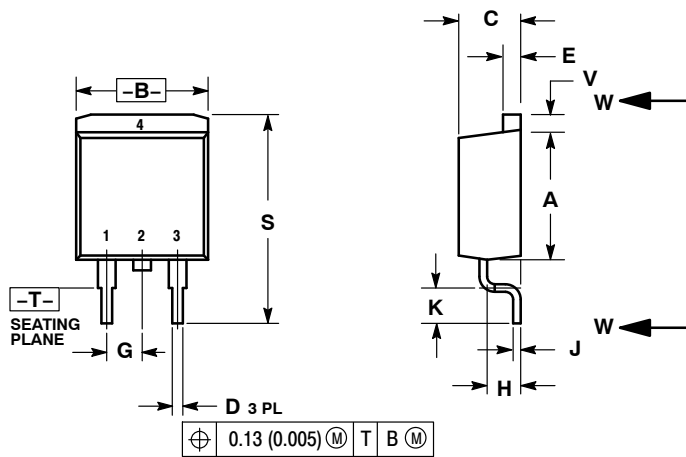

- NOTES:
1. DIMENSIONING AND TOLERANCING PER ANSI Y14.5M, 1982.
 2. CONTROLLING DIMENSION: INCH.
 3. 418B-01 THRU 418B-03 OBSOLETE, NEW STANDARD 418B-04.

DIM	INCHES		MILLIMETERS	
	MIN	MAX	MIN	MAX
A	0.340	0.380	8.64	9.65
B	0.380	0.405	9.65	10.29
C	0.160	0.190	4.06	4.83
D	0.020	0.035	0.51	0.89
E	0.045	0.055	1.14	1.40
F	0.310	0.350	7.87	8.89
G	0.100 BSC		2.54 BSC	
H	0.080	0.110	2.03	2.79
J	0.018	0.025	0.46	0.64
K	0.090	0.110	2.29	2.79
L	0.052	0.072	1.32	1.83
M	0.280	0.320	7.11	8.13
N	0.197 REF		5.00 REF	
P	0.079 REF		2.00 REF	
R	0.039 REF		0.99 REF	
S	0.575	0.625	14.60	15.88
V	0.045	0.055	1.14	1.40

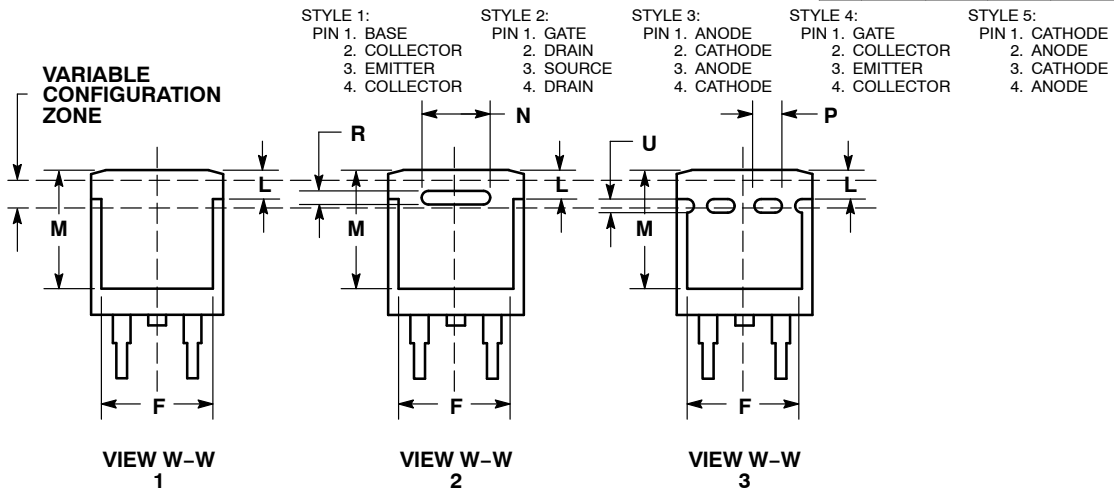

SOLDERING FOOTPRINT*

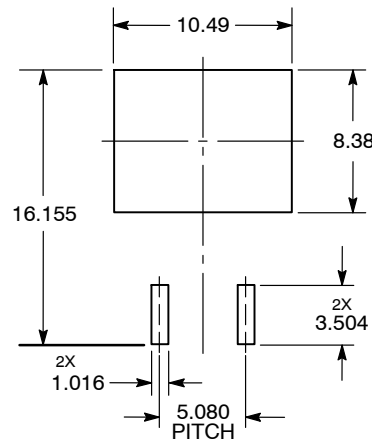

DIMENSIONS: MILLIMETERS

*For additional information on our Pb-Free strategy and soldering details, please download the ON Semiconductor Soldering and Mounting Techniques Reference Manual, SOLDERRM/D.

MBRB30H60CT-1G, MBR30H60CTG, MBRF30H60CTG, MBRB30H60CTT4G

PACKAGE DIMENSIONS

TO-220 FULLPAK CASE 221D-03 ISSUE K

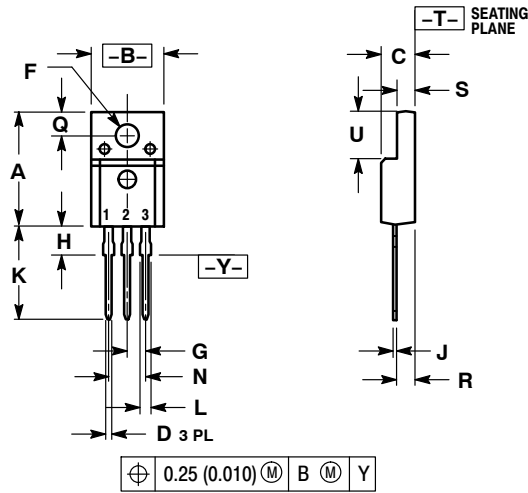

- NOTES:
- DIMENSIONING AND TOLERANCING PER ANSI Y14.5M, 1982.
 - CONTROLLING DIMENSION: INCH
 - 221D-01 THRU 221D-02 OBSOLETE, NEW STANDARD 221D-03.

DIM	INCHES		MILLIMETERS	
	MIN	MAX	MIN	MAX
A	0.617	0.635	15.67	16.12
B	0.392	0.419	9.96	10.63
C	0.177	0.193	4.50	4.90
D	0.024	0.039	0.60	1.00
F	0.116	0.129	2.95	3.28
G	0.100 BSC		2.54 BSC	
H	0.118	0.135	3.00	3.43
J	0.018	0.025	0.45	0.63
K	0.503	0.541	12.78	13.73
L	0.048	0.058	1.23	1.47
N	0.200 BSC		5.08 BSC	
Q	0.122	0.138	3.10	3.50
R	0.099	0.117	2.51	2.96
S	0.092	0.113	2.34	2.87
U	0.239	0.271	6.06	6.88

- STYLE 3:
PIN 1. ANODE
2. CATHODE
3. ANODE

FULLPAK and SWITCHMODE are trademarks of Semiconductor Components Industries, LLC.

ON Semiconductor and are registered trademarks of Semiconductor Components Industries, LLC (SCILLC). SCILLC reserves the right to make changes without further notice to any products herein. SCILLC makes no warranty, representation or guarantee regarding the suitability of its products for any particular purpose, nor does SCILLC assume any liability arising out of the application or use of any product or circuit, and specifically disclaims any and all liability, including without limitation special, consequential or incidental damages. "Typical" parameters which may be provided in SCILLC data sheets and/or specifications can and do vary in different applications and actual performance may vary over time. All operating parameters, including "Typicals" must be validated for each customer application by customer's technical experts. SCILLC does not convey any license under its patent rights nor the rights of others. SCILLC products are not designed, intended, or authorized for use as components in systems intended for surgical implant into the body, or other applications intended to support or sustain life, or for any other application in which the failure of the SCILLC product could create a situation where personal injury or death may occur. Should Buyer purchase or use SCILLC products for any such unintended or unauthorized application, Buyer shall indemnify and hold SCILLC and its officers, employees, subsidiaries, affiliates, and distributors harmless against all claims, costs, damages, and expenses, and reasonable attorney fees arising out of, directly or indirectly, any claim of personal injury or death associated with such unintended or unauthorized use, even if such claim alleges that SCILLC was negligent regarding the design or manufacture of the part. SCILLC is an Equal Opportunity/Affirmative Action Employer. This literature is subject to all applicable copyright laws and is not for resale in any manner.

PUBLICATION ORDERING INFORMATION

LITERATURE FULFILLMENT:
Literature Distribution Center for ON Semiconductor
P.O. Box 5163, Denver, Colorado 80217 USA
Phone: 303-675-2175 or 800-344-3860 Toll Free USA/Canada
Fax: 303-675-2176 or 800-344-3867 Toll Free USA/Canada
Email: orderlit@onsemi.com

N. American Technical Support: 800-282-9855 Toll Free
USA/Canada
Europe, Middle East and Africa Technical Support:
Phone: 421 33 790 2910
Japan Customer Focus Center
Phone: 81-3-5773-3850

ON Semiconductor Website: www.onsemi.com
Order Literature: <http://www.onsemi.com/orderlit>

For additional information, please contact your local Sales Representative

MBRB30H60CT-1/D