

MBR2045CT, MBRF2045CT

SWITCHMODE™ Power Rectifier

Features and Benefits

- Low Forward Voltage
- Low Power Loss / High Efficiency
- High Surge Capacity
- 175°C Operating Junction Temperature
- 20 A Total (10 A Per Diode Leg)
- Pb-Free Package is Available*

Applications

- Power Supply – Output Rectification
- Power Management
- Instrumentation

Mechanical Characteristics

- Case: Epoxy, Molded
- Epoxy Meets UL 94, V-0 @ 0.125 in
- Weight: 1.9 Grams (Approximately)
- Finish: All External Surfaces Corrosion Resistant and Terminal Leads are Readily Solderable
- Lead Temperature for Soldering Purposes: 260°C Max. for 10 Seconds
- ESD Rating: Human Body Model = 3B
Machine Model = C



ON Semiconductor®

<http://onsemi.com>

SCHOTTKY BARRIER RECTIFIER 20 AMPERES, 45 VOLTS

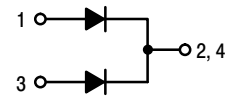

MARKING DIAGRAMS

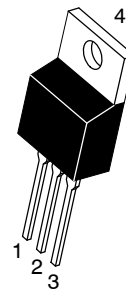

TO-220AB
CASE 221A
STYLE 6

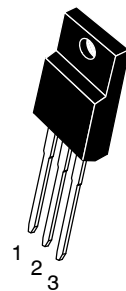
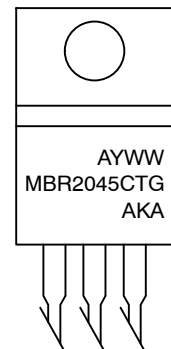

TO-220 FULLPAK
CASE 221D
STYLE 3

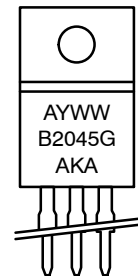

A = Assembly Location
Y = Year
WW = Work Week
G = Pb-Free Package
AKA = Diode Polarity

*For additional information on our Pb-Free strategy and soldering details, please download the ON Semiconductor Soldering and Mounting Techniques Reference Manual, SOLDERRM/D.

ORDERING INFORMATION

See detailed ordering and shipping information in the package dimensions section on page 2 of this data sheet.

MBR2045CT, MBRF2045CT

MAXIMUM RATINGS

Rating	Symbol	Value	Unit
Peak Repetitive Reverse Voltage Working Peak Reverse Voltage DC Blocking Voltage	V_{RRM} V_{RWM} V_R	45	V
Average Rectified Forward Current Per Device Per Diode ($T_C = 165^\circ\text{C}$)	$I_{F(AV)}$	20 10	A
Peak Repetitive Forward Current per Diode Leg (Square Wave, 20 kHz, $T_C = 163^\circ\text{C}$)	I_{FRM}	20	A
Non-Repetitive Peak Surge Current (Surge Applied at Rated Load Conditions Halfwave, Single Phase, 60 Hz)	I_{FSM}	150	A
Peak Repetitive Reverse Surge Current (2.0 μs , 1.0 kHz) See Figure 13	I_{RRM}	1.0	A
Storage Temperature Range	T_{stg}	-65 to +175	$^\circ\text{C}$
Operating Junction Temperature (Note 1)	T_J	-65 to +175	$^\circ\text{C}$
Voltage Rate of Change (Rated V_R)	dv/dt	10,000	V/ μs

Stresses exceeding Maximum Ratings may damage the device. Maximum Ratings are stress ratings only. Functional operation above the Recommended Operating Conditions is not implied. Extended exposure to stresses above the Recommended Operating Conditions may affect device reliability.

1. The heat generated must be less than the thermal conductivity from Junction-to-Ambient: $dP_D/dT_J < 1/R_{\theta JA}$.

THERMAL CHARACTERISTICS

Characteristic	Symbol	Value	Unit
Maximum Thermal Resistance (MBR2045CT) - Junction-to-Case - Junction-to-Ambient	$R_{\theta JC}$ $R_{\theta JA}$	2.0 60	$^\circ\text{C}/\text{W}$
(MBRF2045CT) - Junction-to-Case - Junction-to-Ambient	$R_{\theta JC}$ $R_{\theta JA}$	4.75 75	

ELECTRICAL CHARACTERISTICS

Characteristic	Symbol	Min	Typ	Max	Unit
Instantaneous Forward Voltage (Note 2) ($i_F = 10$ Amps, $T_J = 125^\circ\text{C}$) ($i_F = 20$ Amps, $T_J = 125^\circ\text{C}$) ($i_F = 20$ Amps, $T_J = 25^\circ\text{C}$)	V_F	- - -	0.50 0.67 0.71	0.57 0.72 0.84	V
Instantaneous Reverse Current (Note 2) (Rated dc Voltage, $T_J = 125^\circ\text{C}$) (Rated dc Voltage, $T_J = 25^\circ\text{C}$)	i_R	- -	10.4 0.02	15 0.1	mA

2. Pulse Test: Pulse Width = 300 μs , Duty Cycle $\leq 2.0\%$.

DEVICE ORDERING INFORMATION

Device Order Number	Package Type	Shipping [†]
MBR2045CT	TO-220	50 Units / Rail
MBR2045CTG	TO-220 (Pb-Free)	50 Units / Rail
MBRF2045CTG	TO-220FP (Pb-Free)	50 Units / Rail

MBR2045CT, MBRF2045CT

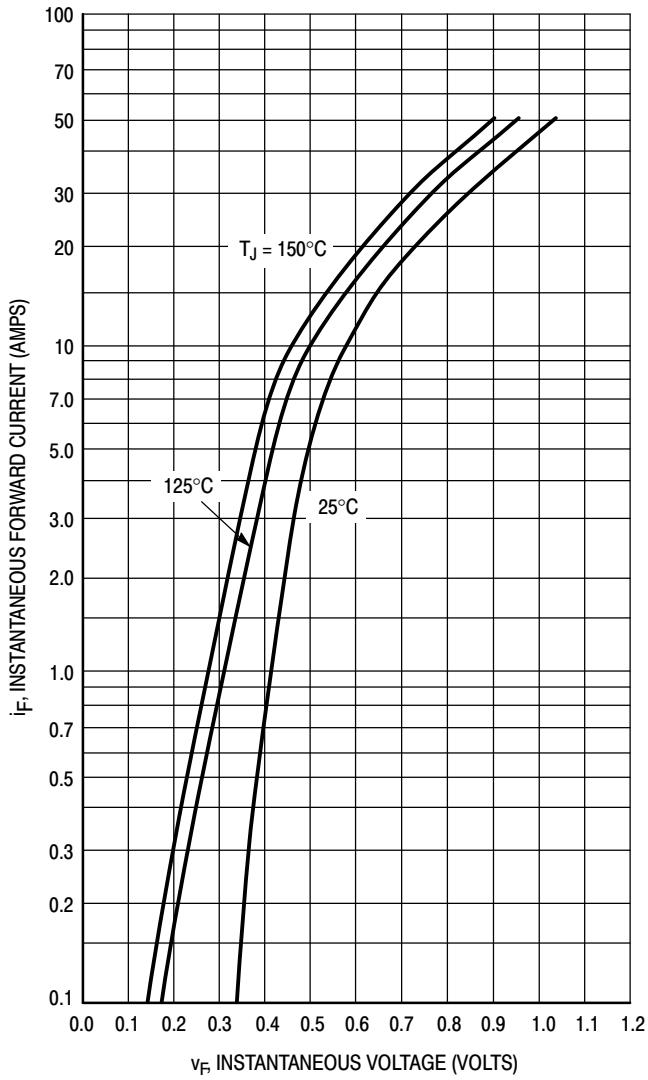

Figure 1. Typical Forward Voltage

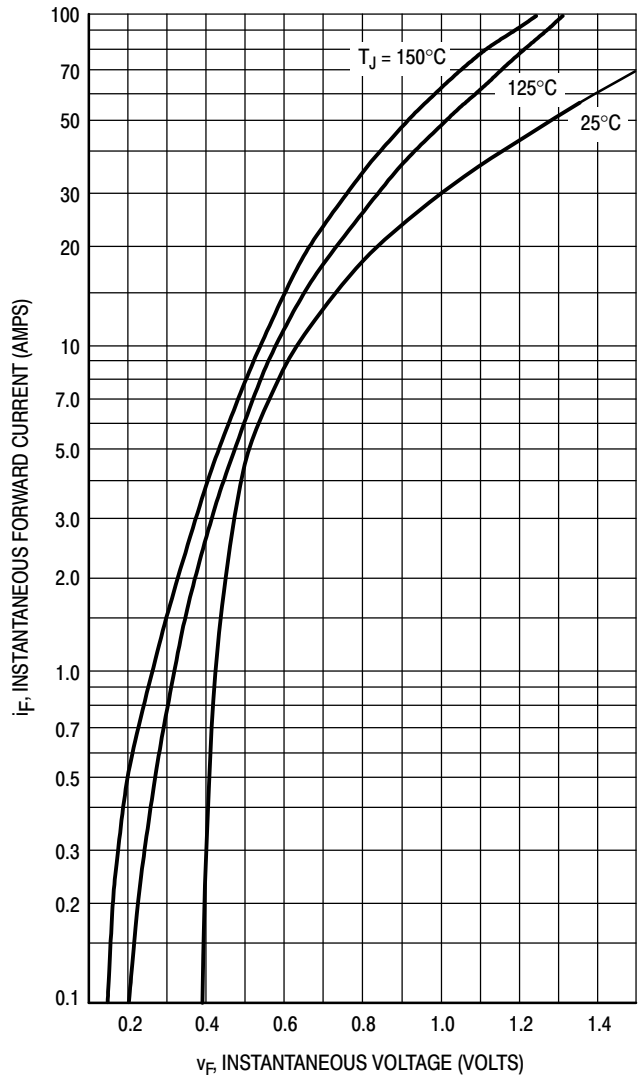

Figure 2. Maximum Forward Voltage

MBR2045CT, MBRF2045CT

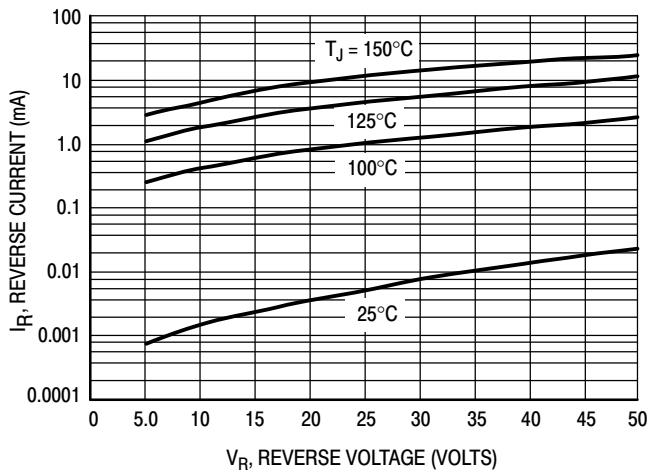

Figure 3. Typical Reverse Current

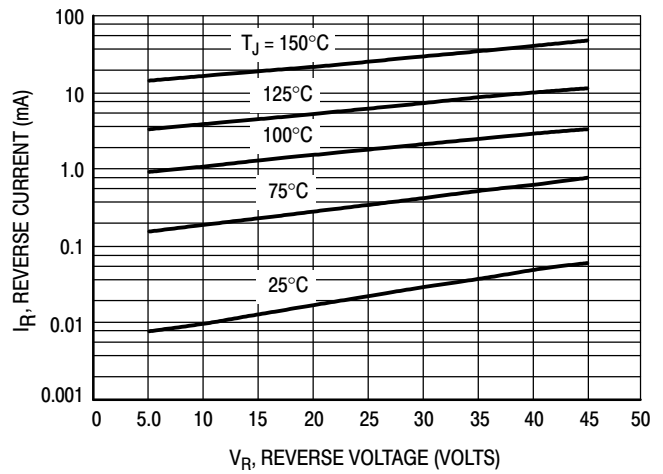

Figure 4. Maximum Reverse Current

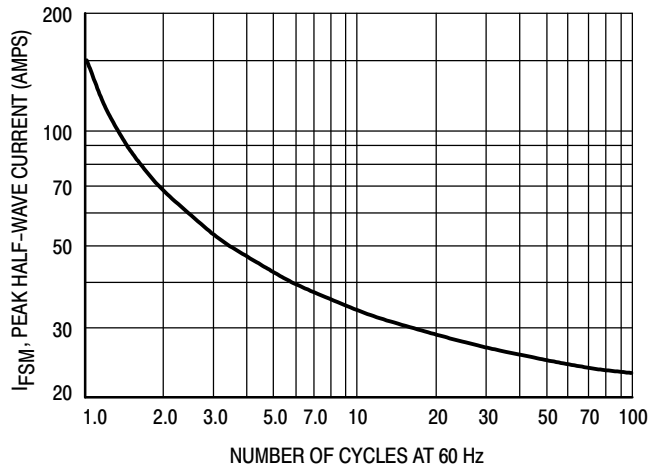

Figure 5. Maximum Surge Capability

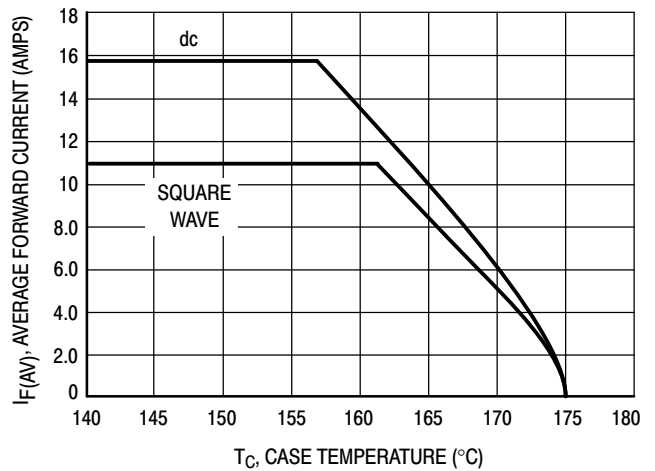

Figure 6. Current Derating, Case, Per Leg

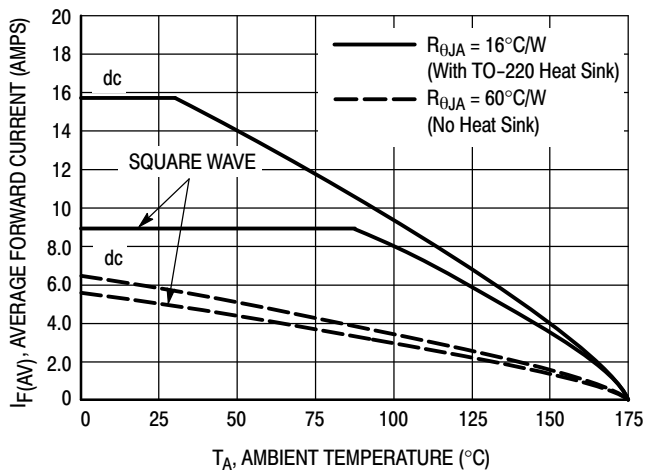

Figure 7. Current Derating, Ambient, Per Leg

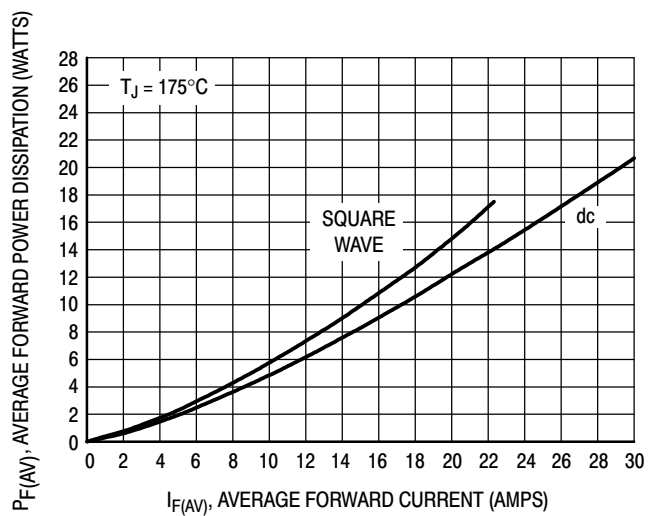

Figure 8. Forward Power Dissipation

MBR2045CT, MBRF2045CT

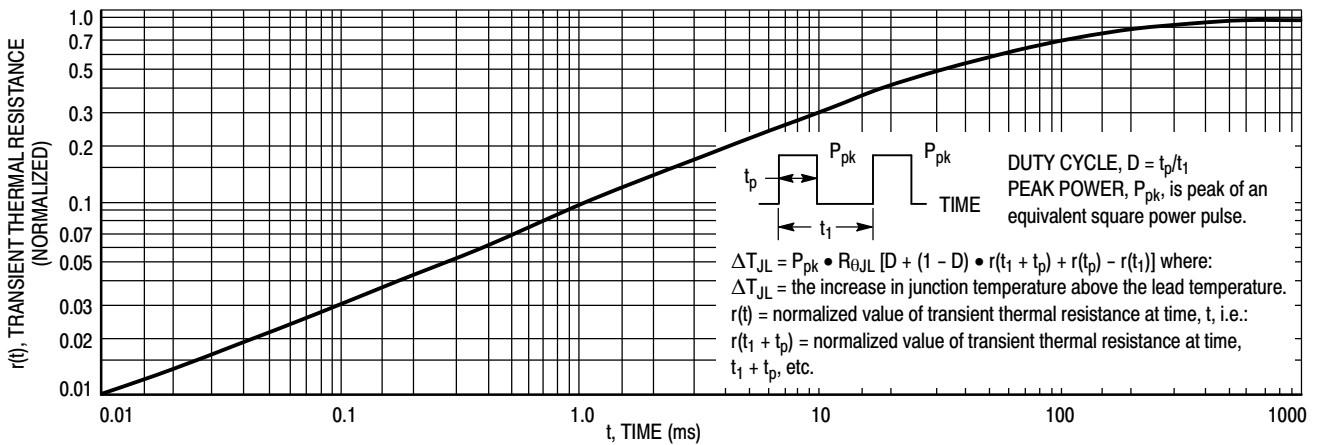

Figure 9. Thermal Response for MBR2045CT

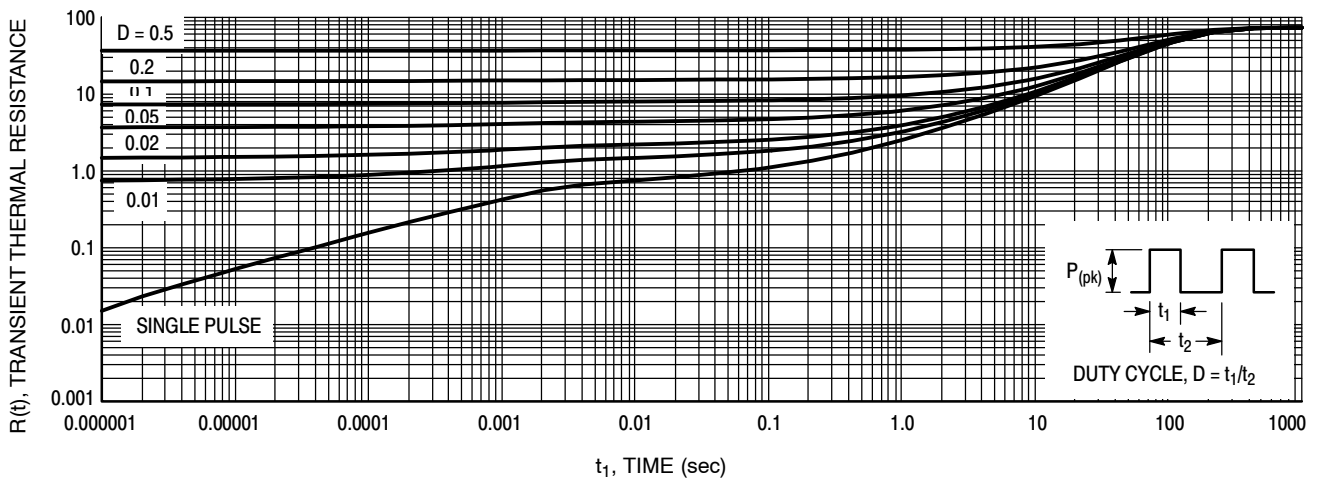

Figure 10. Thermal Response Junction-to-Ambient for MBRF2045CT

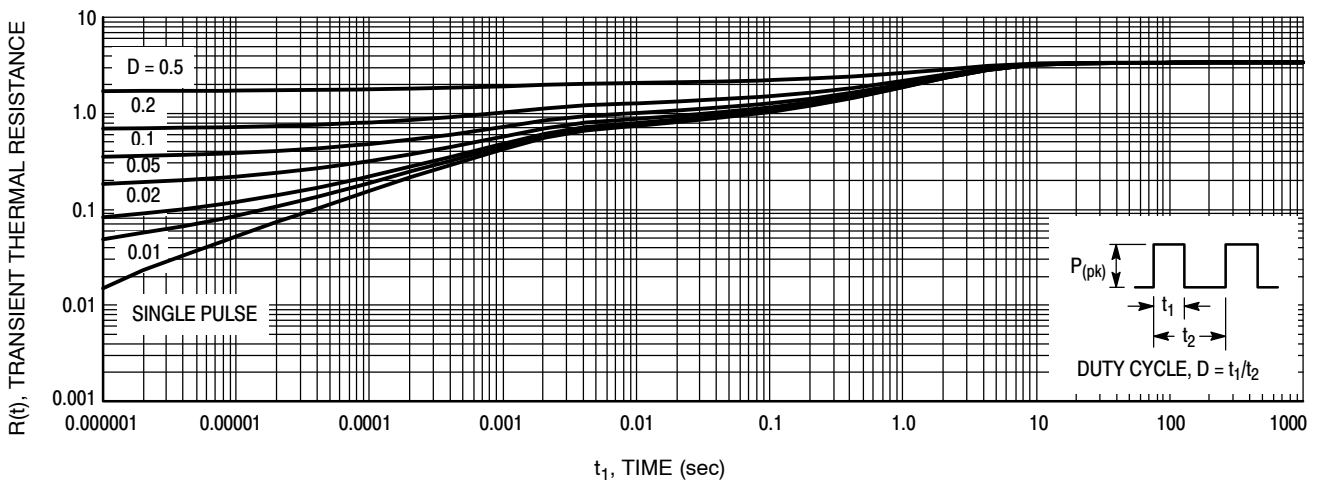

Figure 11. Thermal Response Junction-to-Case for MBRF2045CT

MBR2045CT, MBRF2045CT

HIGH FREQUENCY OPERATION

Since current flow in a Schottky rectifier is the result of majority carrier conduction, it is not subject to junction diode forward and reverse recovery transients due to minority carrier injection and stored charge. Satisfactory circuit analysis work may be performed by using a model consisting of an ideal diode in parallel with a variable capacitance. (See Figure 12.)

Rectification efficiency measurements show that operation will be satisfactory up to several megahertz. For example, relative waveform rectification efficiency is approximately 70 percent at 2.0 MHz, e.g., the ratio of dc power to RMS power in the load is 0.28 at this frequency, whereas perfect rectification would yield 0.406 for sine wave inputs. However, in contrast to ordinary junction diodes, the loss in waveform efficiency is not indicative of power loss; it is simply a result of reverse current flow through the diode capacitance, which lowers the dc output voltage.

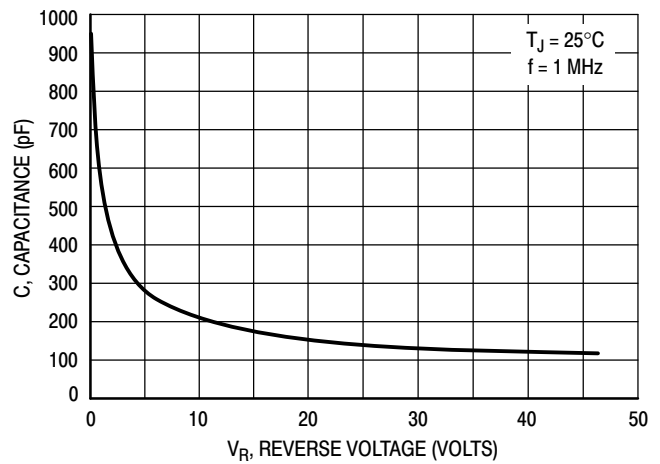

Figure 12. Typical Capacitance

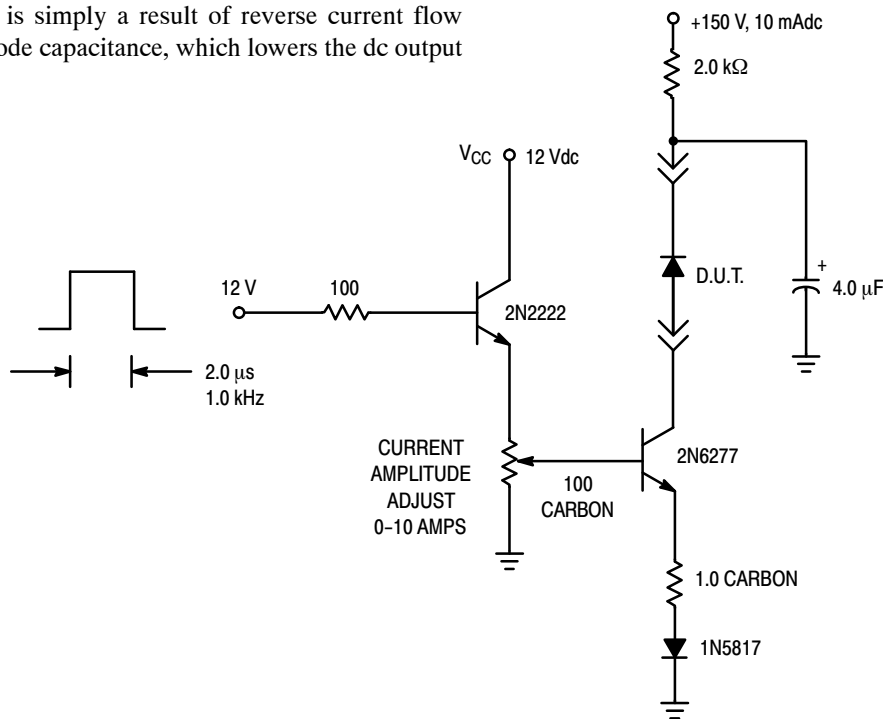
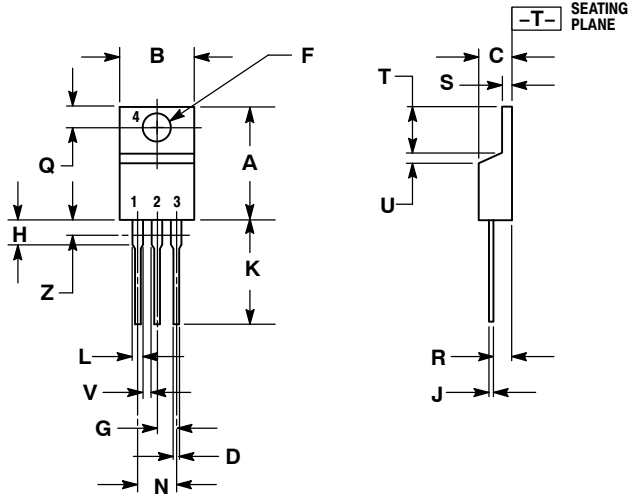

Figure 13. Test Circuit for dv/dt and Reverse Surge Current

MBR2045CT, MBRF2045CT

PACKAGE DIMENSIONS

TO-220
CASE 221A-09
ISSUE AF



NOTES:

1. DIMENSIONING AND TOLERANCING PER ANSI Y14.5M, 1982.
2. CONTROLLING DIMENSION: INCH.
3. DIMENSION Z DEFINES A ZONE WHERE ALL BODY AND LEAD IRREGULARITIES ARE ALLOWED.

DIM	INCHES		MILLIMETERS	
	MIN	MAX	MIN	MAX
A	0.570	0.620	14.48	15.75
B	0.380	0.405	9.66	10.28
C	0.160	0.190	4.07	4.82
D	0.025	0.035	0.64	0.88
F	0.142	0.161	3.61	4.09
G	0.095	0.105	2.42	2.66
H	0.110	0.155	2.80	3.93
J	0.014	0.025	0.36	0.64
K	0.500	0.562	12.70	14.27
L	0.045	0.060	1.15	1.52
N	0.190	0.210	4.83	5.33
Q	0.100	0.120	2.54	3.04
R	0.080	0.110	2.04	2.79
S	0.045	0.055	1.15	1.39
T	0.235	0.255	5.97	6.47
U	0.000	0.050	0.00	1.27
V	0.045	---	1.15	---
Z	---	0.080	---	2.04

STYLE 6:

- PIN 1. ANODE
- CATHODE
- ANODE
- CATHODE

MBR2045CT, MBRF2045CT

PACKAGE DIMENSIONS

TO-220 FULLPAK
CASE 221D-03
ISSUE J

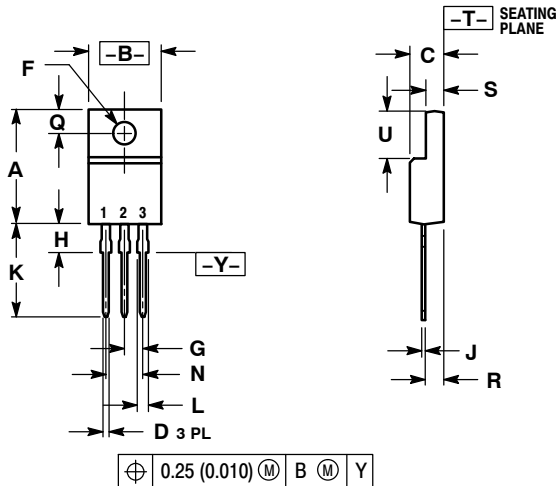

NOTES:

1. DIMENSIONING AND TOLERANCING PER ANSI Y14.5M, 1982.
2. CONTROLLING DIMENSION: INCH
3. 221D-01 THRU 221D-02 OBSOLETE, NEW STANDARD 221D-03.

DIM	INCHES		MILLIMETERS	
	MIN	MAX	MIN	MAX
A	0.617	0.635	15.67	16.12
B	0.392	0.419	9.96	10.63
C	0.177	0.193	4.50	4.90
D	0.024	0.039	0.60	1.00
F	0.116	0.129	2.95	3.28
G	0.100 BSC		2.54 BSC	
H	0.118	0.135	3.00	3.43
J	0.018	0.025	0.45	0.63
K	0.503	0.541	12.78	13.73
L	0.048	0.058	1.23	1.47
N	0.200 BSC		5.08 BSC	
Q	0.122	0.138	3.10	3.50
R	0.099	0.117	2.51	2.96
S	0.092	0.113	2.34	2.87
U	0.239	0.271	6.06	6.88

STYLE 3:

1. ANODE
2. CATHODE
3. ANODE

SWITCHMODE is a trademark of Semiconductor Components Industries, LLC.

ON Semiconductor and are registered trademarks of Semiconductor Components Industries, LLC (SCILLC). SCILLC reserves the right to make changes without further notice to any products herein. SCILLC makes no warranty, representation or guarantee regarding the suitability of its products for any particular purpose, nor does SCILLC assume any liability arising out of the application or use of any product or circuit, and specifically disclaims any and all liability, including without limitation special, consequential or incidental damages. "Typical" parameters which may be provided in SCILLC data sheets and/or specifications can and do vary in different applications and actual performance may vary over time. All operating parameters, including "Typicals" must be validated for each customer application by customer's technical experts. SCILLC does not convey any license under its patent rights nor the rights of others. SCILLC products are not designed, intended, or authorized for use as components in systems intended for surgical implant into the body, or other applications intended to support or sustain life, or for any other application in which the failure of the SCILLC product could create a situation where personal injury or death may occur. Should Buyer purchase or use SCILLC products for any such unintended or unauthorized application, Buyer shall indemnify and hold SCILLC and its officers, employees, subsidiaries, affiliates, and distributors harmless against all claims, costs, damages, and expenses, and reasonable attorney fees arising out of, directly or indirectly, any claim of personal injury or death associated with such unintended or unauthorized use, even if such claim alleges that SCILLC was negligent regarding the design or manufacture of the part. SCILLC is an Equal Opportunity/Affirmative Action Employer. This literature is subject to all applicable copyright laws and is not for resale in any manner.

PUBLICATION ORDERING INFORMATION

LITERATURE FULFILLMENT:

Literature Distribution Center for ON Semiconductor
P.O. Box 5163, Denver, Colorado 80217 USA
Phone: 303-675-2175 or 800-344-3860 Toll Free USA/Canada
Fax: 303-675-2176 or 800-344-3867 Toll Free USA/Canada
Email: orderlit@onsemi.com

N. American Technical Support: 800-282-9855 Toll Free
USA/Canada
Europe, Middle East and Africa Technical Support:
Phone: 421 33 790 2910
Japan Customer Focus Center
Phone: 81-3-5773-3850

ON Semiconductor Website: www.onsemi.com

Order Literature: <http://www.onsemi.com/orderlit>

For additional information, please contact your local Sales Representative

MBR2045CT/D