

## High frequency secondary rectifier

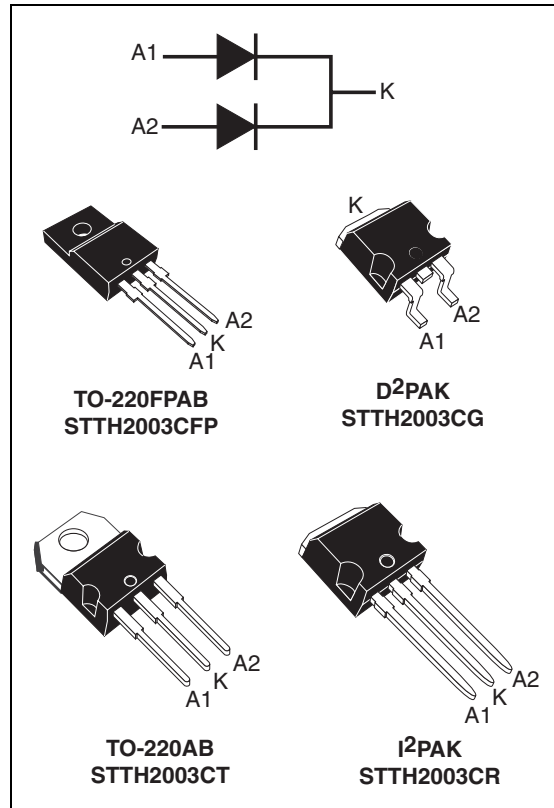
### Features

- Combines highest recovery and reverse voltage performance
- Ultra-fast, soft and noise-free recovery
- Insulated package TO-220FPAB:
  - Electrical insulation: 2000 V DC
  - Capacitance: 12 pF

### Description

Dual center tap fast recovery epitaxial diodes suited for switch mode power supply and high frequency DC/DC converters.

Packaged in TO-220AB, TO-220FPAB, I<sup>2</sup>PAK or D<sup>2</sup>PAK, this device is especially intended for secondary rectification.



**Table 1. Device summary**

Symbol	Value
$I_{F(AV)}$	2 x 10 A
$V_{RRM}$	300 V
$T_j$ (max)	175 °C
$V_F$ (max)	1 V
$t_{rr}$ (typ)	35 ns

# 1 Characteristics

**Table 2. Absolute ratings (limiting values, per diode)**

Symbol	Parameter			Value	Unit	
$V_{RRM}$	Repetitive peak reverse voltage			300	V	
$I_{F(RMS)}$	Forward current rms			30	A	
$I_{F(peak)}$	Peak working forward current $\delta = 0.5$	$I^2PAK, D^2PAK, TO-220AB$	$T_c = 140\text{ }^\circ\text{C}$	Per diode Per device	10 20	A
		TO-220FPAB	$T_c = 125\text{ }^\circ\text{C}$			
$I_{FSM}$	Surge non repetitive forward current		$t_p = 10\text{ ms sinusoidal}$	110	A	
$I_{RSM}$	Non repetitive avalanche current		$t_p = 10\text{ }\mu\text{s square}$	5	A	
$T_{stg}$	Storage temperature range			-65 to + 175	$^\circ\text{C}$	
$T_j$	Maximum operating junction temperature			175	$^\circ\text{C}$	

**Table 3. Thermal resistance**

Symbol	Parameter			Value (max)	Unit
$R_{th(j-c)}$	Junction to case	$I^2PAK, D^2PAK, TO-220AB$	Per diode	2.5	$^\circ\text{C/W}$
			Total	1.3	
		TO-220FPAB	Per diode	4.6	
			Total	4	
$R_{th(c)}$	Coupling	$I^2PAK, D^2PAK, TO-220AB$		0.1	
		TO-220FPAB		3.5	

**Table 4. Static electrical characteristics (per diode)**

Symbol	Parameter	Test conditions		Min.	Typ.	Max.	Unit
$I_R^{(1)}$	Reverse leakage current	$T_j = 25\text{ }^\circ\text{C}$	$V_R = 300\text{ V}$			20	$\mu\text{A}$
		$T_j = 125\text{ }^\circ\text{C}$			30	300	
$V_F^{(2)}$	Forward voltage drop	$T_j = 25\text{ }^\circ\text{C}$	$I_F = 10\text{ A}$			1.25	V
		$T_j = 125\text{ }^\circ\text{C}$			0.85	1	

1. Pulse test:  $t_p = 5\text{ ms}$ ,  $\delta < 2\%$

2. Pulse test:  $t_p = 380\text{ }\mu\text{s}$ ,  $\delta < 2\%$

To evaluate the conduction losses use the following equation:  $P = 0.75 \times I_{F(AV)} + 0.025 I_F^2 (RMS)$

Table 5. Recovery characteristics

Symbol	Parameter	Test conditions		Min.	Typ.	Max.	Unit
$t_{rr}$	Reverse recovery time	$T_j = 25\text{ }^\circ\text{C}$	$I_F = 0.5\text{ A}, I_{rr} = 0.25\text{ A}$ $I_R = 1\text{ A}$			25	ns
			$I_F = 1\text{ A}, V_R = 30\text{ V}$ $di_F/dt = -50\text{ A}/\mu\text{s}$			35	
$t_{fr}$	Forward recovery time	$T_j = 25\text{ }^\circ\text{C}$	$I_F = 10\text{ A}$ $di_F/dt = 100\text{ A}/\mu\text{s}$ $V_{FR} = 1.1 \times V_{Fmax}$			230	ns
$V_{FP}$	Peak forward voltage	$T_j = 25\text{ }^\circ\text{C}$	$I_F = 10\text{ A},$ $di_F/dt = 100\text{ A}/\mu\text{s}$			3.5	V
$I_{RM}$	Reverse recovery current	$T_j = 125\text{ }^\circ\text{C}$	$I_F = 10\text{ A}, V_{CC} = 200\text{ V}$ $di_F/dt = 200\text{ A}/\mu\text{s}$			8	A
S factor	Softness factor				0.3	-	

Figure 1. Conduction losses versus average forward current (per diode)

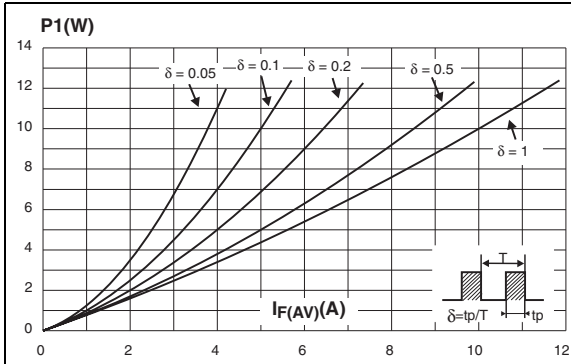


Figure 2. Forward voltage drop versus forward current (maximum values, per diode)

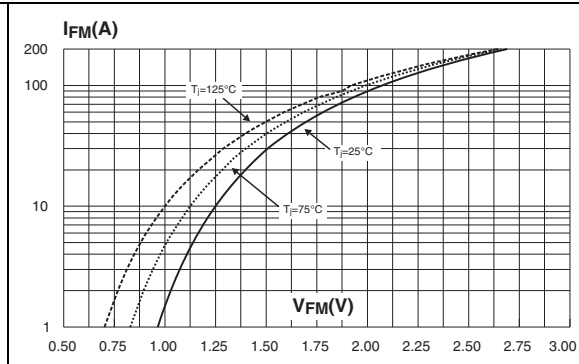


Figure 3. Relative variation of thermal impedance junction to case versus pulse duration

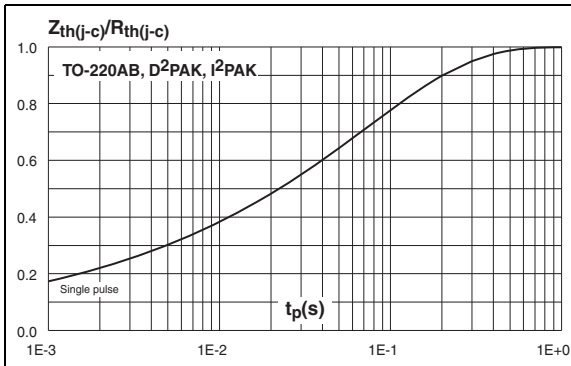
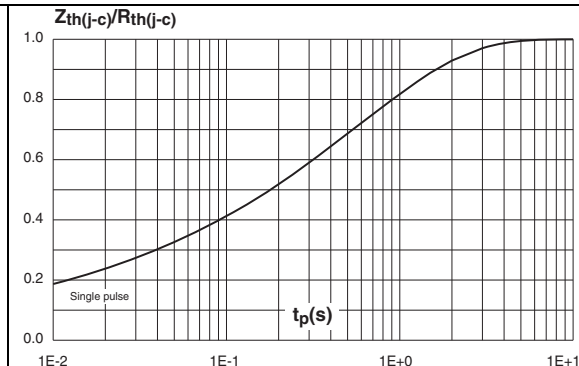
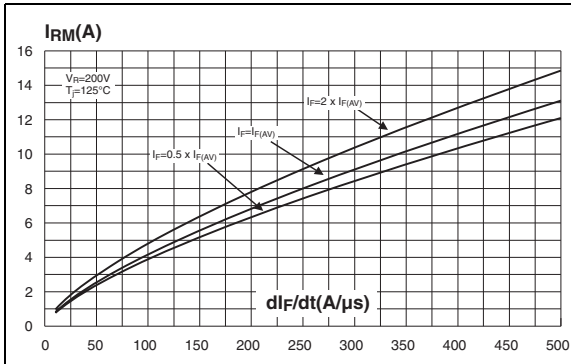


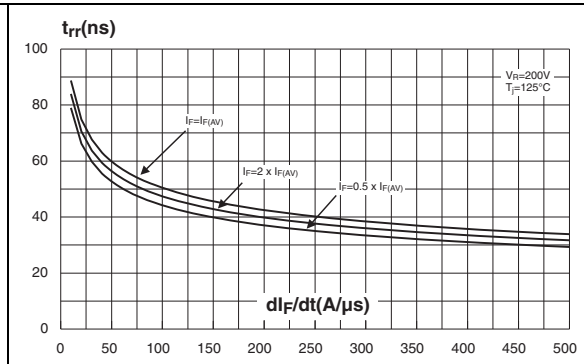
Figure 4. Relative variation of thermal impedance junction to case versus pulse duration (TO-22FP0AB)



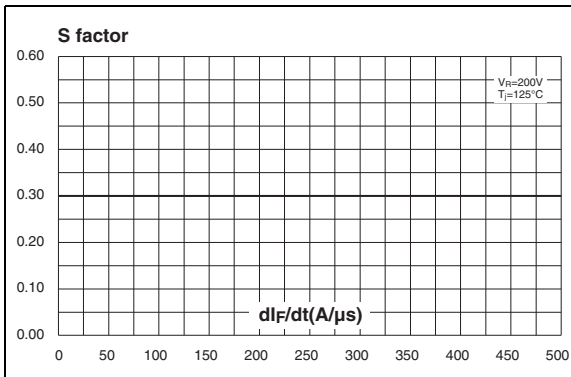
**Figure 5. Peak reverse recovery current versus  $di_F/dt$  (90% confidence, per diode)**



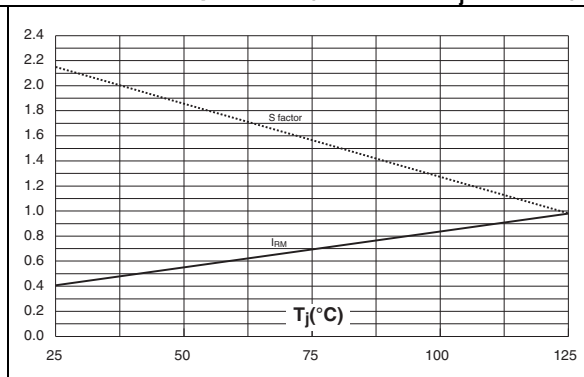
**Figure 6. Reverse recovery time versus  $di_F/dt$  (90% confidence, per diode)**



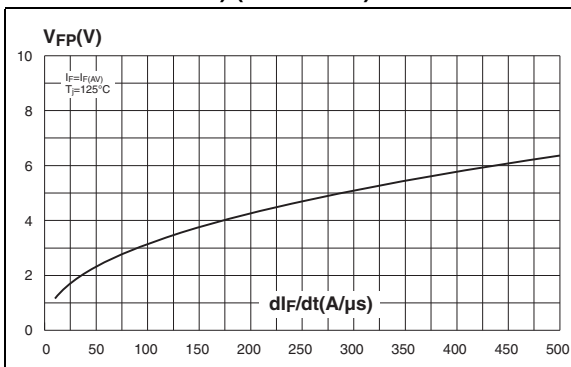
**Figure 7. Softness factor (tb/ta) versus  $di_F/dt$  (typical values, per diode)**



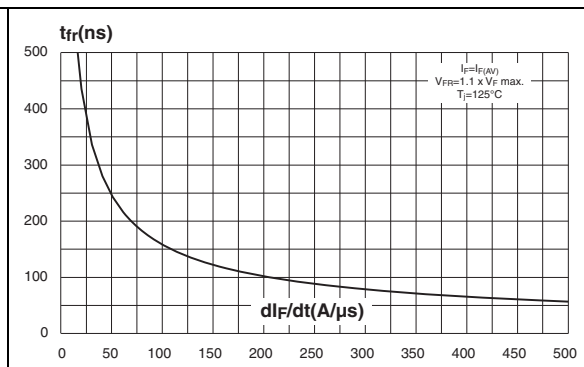
**Figure 8. Relative variation of dynamic parameters versus junction temperature (reference:  $T_J = 125^\circ C$ )**

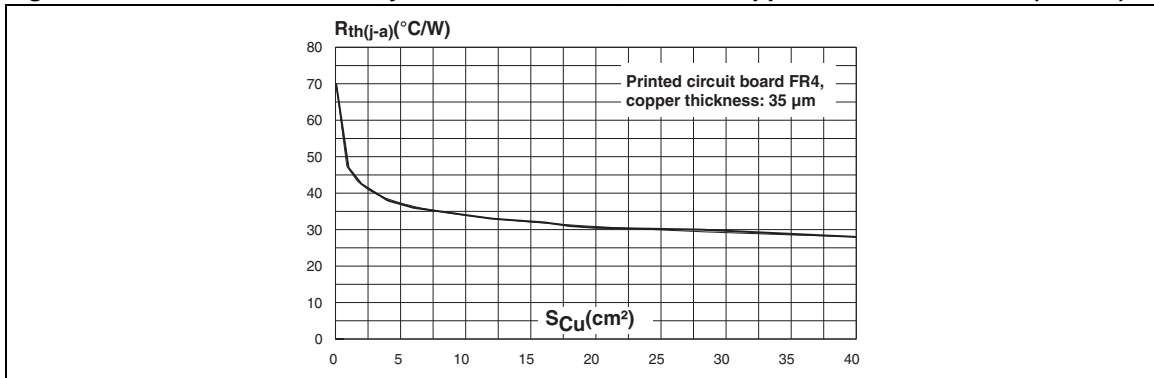


**Figure 9. Transient peak forward voltage versus  $di_F/dt$  (90% confidence, per diode) (TO-220AB)**



**Figure 10. Forward recovery time versus  $di_F/dt$  (90% confidence, per diode)**



**Figure 11. Thermal resistance, junction to ambient, versus copper surface under tab (D<sup>2</sup>PAK)**

## 2 Package information

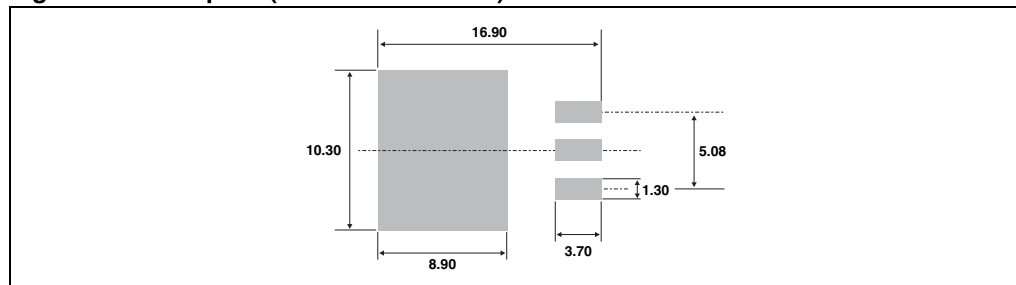
- Epoxy meets UL94, V0
- Cooling method: by conduction (C)
- Recommended torque value: 0.4 to 0.6 N·m

In order to meet environmental requirements, ST offers these devices in different grades of ECOPACK® packages, depending on their level of environmental compliance. ECOPACK® specifications, grade definitions and product status are available at: [www.st.com](http://www.st.com). ECOPACK® is an ST trademark.

Table 6. D<sup>2</sup>PAK dimensions

Ref.	Dimensions			
	Millimeters		Inches	
	Min.	Max.	Min.	Max.
A	4.40	4.60	0.173	0.181
A1	2.49	2.69	0.098	0.106
A2	0.03	0.23	0.001	0.009
B	0.70	0.93	0.027	0.037
B2	1.14	1.70	0.045	0.067
C	0.45	0.60	0.017	0.024
C2	1.23	1.36	0.048	0.054
D	8.95	9.35	0.352	0.368
E	10.00	10.40	0.393	0.409
G	4.88	5.28	0.192	0.208
L	15.00	15.85	0.590	0.624
L2	1.27	1.40	0.050	0.055
L3	1.40	1.75	0.055	0.069
M	2.40	3.20	0.094	0.126
R	0.40 typ.		0.016 typ.	
V2	0°	8°	0°	8°

Figure 12. Footprint (dimensions in mm)



Devices in I<sup>2</sup>PAK with nickel-plated back frame must NOT be mounted by frame soldering like SMDs. Such devices are intended to be through-hole mounted ONLY and in no circumstances shall ST be held liable for any lack of performance or damage arising out of soldering of nickel-plated back frames.

**Table 7. I<sup>2</sup>PAK dimensions**

Ref.	Dimensions			
	Millimeters		Inches	
	Min.	Max.	Min.	Max.
A	4.40	4.60	0.173	0.181
A1	2.40	2.72	0.094	0.107
b	0.61	0.88	0.024	0.035
b1	1.14	1.70	0.044	0.067
c	0.49	0.70	0.019	0.028
c2	1.23	1.32	0.048	0.052
D	8.95	9.35	0.352	0.368
e	2.40	2.70	0.094	0.106
e1	4.95	5.15	0.195	0.203
E	10	10.40	0.394	0.409
L	13	14	0.512	0.551
L1	3.50	3.93	0.138	0.155
L2	1.27	1.40	0.050	0.055

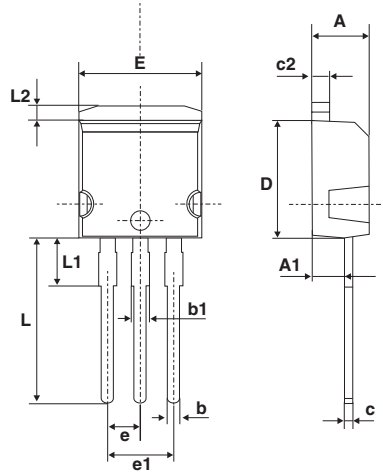


Table 8. TO-220AB dimensions

Ref.	Dimensions			
	Millimeters		Inches	
	Min.	Max.	Min.	Max.
A	4.40	4.60	0.173	0.181
C	1.23	1.32	0.048	0.051
D	2.40	2.72	0.094	0.107
E	0.49	0.70	0.019	0.027
F	0.61	0.88	0.024	0.034
F1	1.14	1.70	0.044	0.066
F2	1.14	1.70	0.044	0.066
G	4.95	5.15	0.194	0.202
G1	2.40	2.70	0.094	0.106
H2	10	10.40	0.393	0.409
L2	16.4 typ.		0.645 typ.	
L4	13	14	0.511	0.551
L5	2.65	2.95	0.104	0.116
L6	15.25	15.75	0.600	0.620
L7	6.20	6.60	0.244	0.259
L9	3.50	3.93	0.137	0.154
M	2.6 typ.		0.102 typ.	
Diam.	3.75	3.85	0.147	0.151

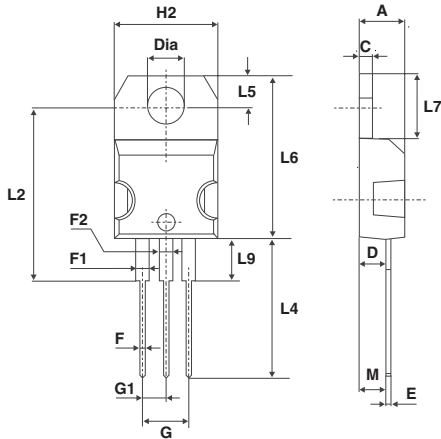
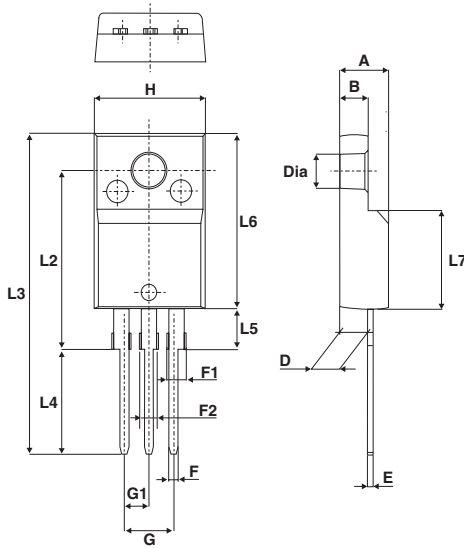




Table 9. TO-220FPAB 3 leads in-line dimensions

Ref.	Dimensions			
	Millimeters		Inches	
	Min.	Max.	Min.	Max.
A	4.4	4.9	0.173	0.192
B	2.5	2.9	0.098	0.114
D	2.45	2.75	0.096	0.108
E	0.4	0.7	0.016	0.028
F	0.6	1	0.024	0.039
F1	1.15	1.7	0.045	0.067
F2	1.15	1.7	0.045	0.067
G	4.95	5.2	0.195	0.205
G1	2.4	2.7	0.094	0.106
H	10	10.7	0.394	0.421
L2	16 Typ.		0.630 Typ.	
L3	28.6	30.6	1.126	1.205
L4	9.8	10.7	0.386	0.421
L6	15.8	16.4	0.622	0.646
L7	9	9.9	0.354	0.390
Dia.	2.9	3.5	0.114	0.138



### 3 Ordering information

Table 10. Ordering information

Order code	Marking	Package	Weight	Base qty	Delivery mode
STTH2003CT	STTH2003CT	TO-220AB	2.2 g	50	Tube
STTH2003CG	STTH2003CG	D <sup>2</sup> PAK	1.48 g	50	Tube
STTH2003CG-TR	STTH2003CG	D <sup>2</sup> PAK	1.48 g	1000	Tape and reel
STTH2003CFP	STTH2003CFP	TO-220FPAB	2.08 g	50	Tube
STTH2003CR	STTH2003CR	I <sup>2</sup> PAK	1.49 g	50	Tube

### 4 Revision history

Table 11. Document revision history

Date	Revision	Changes
Aug-2003	7D	Previous release.
26-Mar-2007	8	Removed ISOWATT package.
11-Feb-2011	9	Updated base quantity for tape and reel delivery in <a href="#">Table 10</a> . Corrected temperature in <a href="#">Table 1</a> . Added warning paragraph above <a href="#">Table 7</a> .

**Please Read Carefully:**

Information in this document is provided solely in connection with ST products. STMicroelectronics NV and its subsidiaries ("ST") reserve the right to make changes, corrections, modifications or improvements, to this document, and the products and services described herein at any time, without notice.

All ST products are sold pursuant to ST's terms and conditions of sale.

Purchasers are solely responsible for the choice, selection and use of the ST products and services described herein, and ST assumes no liability whatsoever relating to the choice, selection or use of the ST products and services described herein.

No license, express or implied, by estoppel or otherwise, to any intellectual property rights is granted under this document. If any part of this document refers to any third party products or services it shall not be deemed a license grant by ST for the use of such third party products or services, or any intellectual property contained therein or considered as a warranty covering the use in any manner whatsoever of such third party products or services or any intellectual property contained therein.

**UNLESS OTHERWISE SET FORTH IN ST'S TERMS AND CONDITIONS OF SALE ST DISCLAIMS ANY EXPRESS OR IMPLIED WARRANTY WITH RESPECT TO THE USE AND/OR SALE OF ST PRODUCTS INCLUDING WITHOUT LIMITATION IMPLIED WARRANTIES OF MERCHANTABILITY, FITNESS FOR A PARTICULAR PURPOSE (AND THEIR EQUIVALENTS UNDER THE LAWS OF ANY JURISDICTION), OR INFRINGEMENT OF ANY PATENT, COPYRIGHT OR OTHER INTELLECTUAL PROPERTY RIGHT.**

**UNLESS EXPRESSLY APPROVED IN WRITING BY AN AUTHORIZED ST REPRESENTATIVE, ST PRODUCTS ARE NOT RECOMMENDED, AUTHORIZED OR WARRANTED FOR USE IN MILITARY, AIR CRAFT, SPACE, LIFE SAVING, OR LIFE SUSTAINING APPLICATIONS, NOR IN PRODUCTS OR SYSTEMS WHERE FAILURE OR MALFUNCTION MAY RESULT IN PERSONAL INJURY, DEATH, OR SEVERE PROPERTY OR ENVIRONMENTAL DAMAGE. ST PRODUCTS WHICH ARE NOT SPECIFIED AS "AUTOMOTIVE GRADE" MAY ONLY BE USED IN AUTOMOTIVE APPLICATIONS AT USER'S OWN RISK.**

Resale of ST products with provisions different from the statements and/or technical features set forth in this document shall immediately void any warranty granted by ST for the ST product or service described herein and shall not create or extend in any manner whatsoever, any liability of ST.

ST and the ST logo are trademarks or registered trademarks of ST in various countries.

Information in this document supersedes and replaces all information previously supplied.

The ST logo is a registered trademark of STMicroelectronics. All other names are the property of their respective owners.

© 2011 STMicroelectronics - All rights reserved

STMicroelectronics group of companies

Australia - Belgium - Brazil - Canada - China - Czech Republic - Finland - France - Germany - Hong Kong - India - Israel - Italy - Japan - Malaysia - Malta - Morocco - Philippines - Singapore - Spain - Sweden - Switzerland - United Kingdom - United States of America

[www.st.com](http://www.st.com)

