

Standard Rectifier

Phase leg

$$\begin{aligned} V_{RRM} &= 1200 \text{ V} \\ I_{FAV} &= 2 \times 45 \text{ A} \\ V_F &= 1.23 \text{ V} \end{aligned}$$

Part number

DSP45-12A

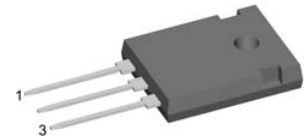
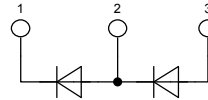

Backside: cathode

Features / Advantages:

- Planar passivated chips
- Very low leakage current
- Very low forward voltage drop
- Improved thermal behaviour

Applications:

- Diode for main rectification
- For single and three phase bridge configurations

Package:

- Housing: TO-247
- Industry standard outline
- Epoxy meets UL 94V-0
- RoHS compliant

Symbol	Definition	Conditions	Ratings			Unit
			min.	typ.	max.	
V_{RRM}	max. repetitive reverse voltage				1200	V
I_R	reverse current	$V_R = 1200 \text{ V}$			20	μA
		$V_R = 1200 \text{ V}$			3	mA
V_F	forward voltage	$I_F = 45 \text{ A}$			1.28	V
		$I_F = 90 \text{ A}$			1.37	V
		$I_F = 45 \text{ A}$			1.23	V
		$I_F = 90 \text{ A}$			1.35	V
I_{FAV}	average forward current	rectangular d = 0.5			45	A
V_{FO}	threshold voltage	} for power loss calculation only			0.81	V
r_F	slope resistance				9.1	m Ω
R_{thJC}	thermal resistance junction to case				0.55	K/W
T_{VJ}	virtual junction temperature		-40		175	$^{\circ}\text{C}$
P_{tot}	total power dissipation				270	W
I_{FSM}	max. forward surge current	t = 10 ms (50 Hz), sine			480	A
		t = 8,3 ms (60 Hz), sine			518	A
		t = 10 ms (50 Hz), sine			408	A
		t = 8,3 ms (60 Hz), sine			441	A
I^2t	value for fusing	t = 10 ms (50 Hz), sine			1152	A ² s
		t = 8,3 ms (60 Hz), sine			1120	A ² s
		t = 10 ms (50 Hz), sine			832	A ² s
		t = 8,3 ms (60 Hz), sine			808	A ² s
C_J	junction capacitance	$V_R = 400 \text{ V}; f = 1 \text{ MHz}$		18		pF

Symbol	Definition	Conditions	Ratings			Unit
			min.	typ.	max.	
I_{RMS}	RMS current	per pin ¹⁾			70	A
R_{thCH}	thermal resistance case to heatsink			0.25		K/W
T_{stg}	storage temperature		-55		150	°C
Weight				6		g
M_D	mounting torque		0.8		1.2	Nm
F_C	mounting force with clip		20		120	N

¹⁾ I_{RMS} is typically limited by: 1. pin-to-chip resistance; or by 2. current capability of the chip.
 In case of 1, a common cathode/anode configuration and a non-isolated backside, the whole current capability can be used by connecting the backside.

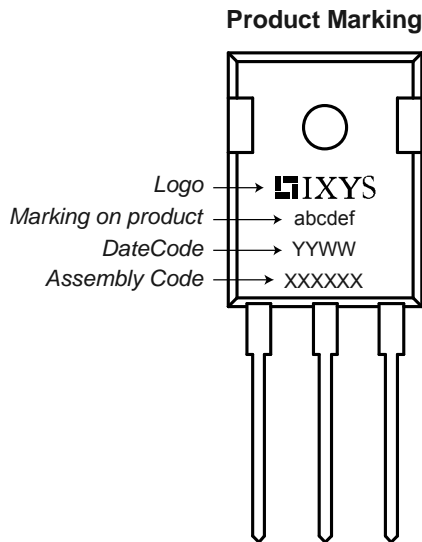

Ordering	Part Name	Marking on Product	Delivering Mode	Base Qty	Code Key
Standard	DSP45-12A	DSP45-12A	Tube	30	480673

Similar Part	Package	Voltage class
DSP45-16A	TO-247AD (3)	1600
DSP45-16AR	ISOPLUS247 (3)	1600

Outlines TO-247

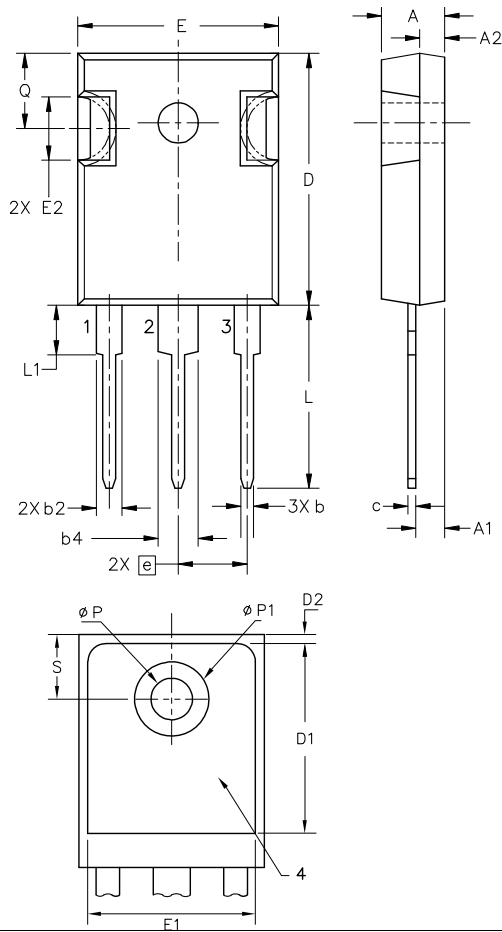

Sym.	Inches		Millimeter	
	min.	max.	min.	max.
A	0.185	0.209	4.70	5.30
A1	0.087	0.102	2.21	2.59
A2	0.059	0.098	1.50	2.49
D	0.819	0.845	20.79	21.45
E	0.610	0.640	15.48	16.24
E2	0.170	0.216	4.31	5.48
e	0.215 BSC		5.46 BSC	
L	0.780	0.800	19.80	20.30
L1	-	0.177	-	4.49
$\varnothing P$	0.140	0.144	3.55	3.65
Q	0.212	0.244	5.38	6.19
S	0.242 BSC		6.14 BSC	
b	0.039	0.055	0.99	1.40
b2	0.065	0.094	1.65	2.39
b4	0.102	0.135	2.59	3.43
c	0.015	0.035	0.38	0.89
D1	0.515	-	13.07	-
D2	0.020	0.053	0.51	1.35
E1	0.530	-	13.45	-
$\varnothing P1$	-	0.29	-	7.39

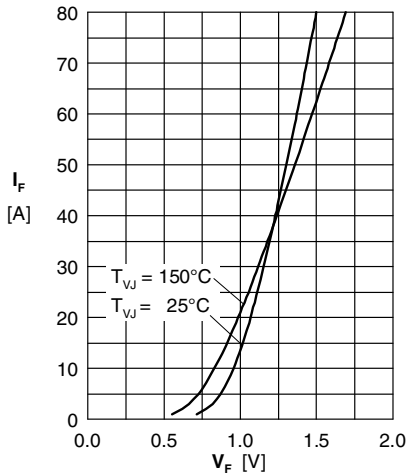

Fig. 1 Forward current versus voltage drop per diode

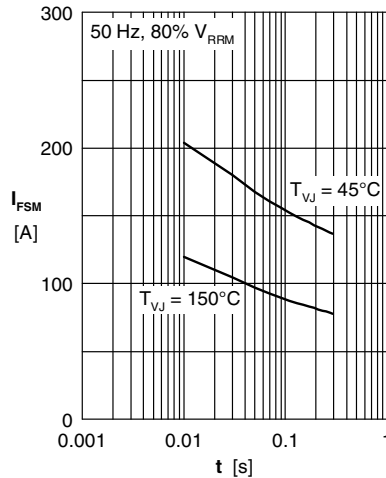

Fig. 2 Surge overload current

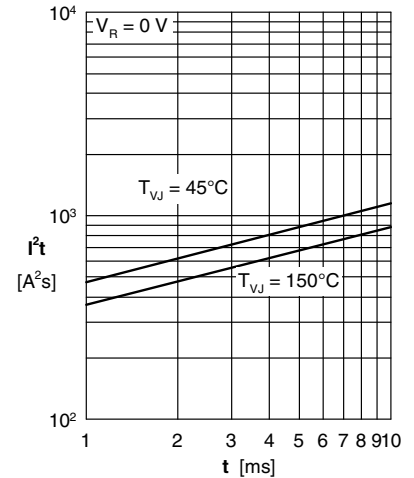

Fig. 3 I^2t versus time per diode

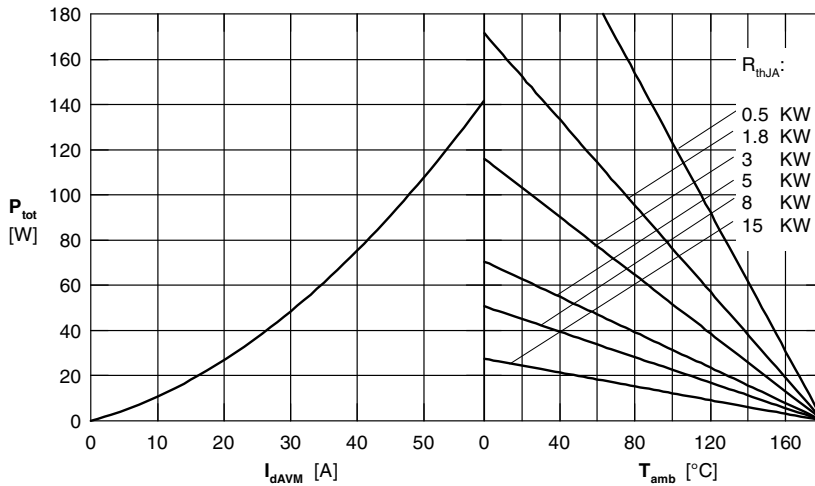

Fig. 4 Power dissipation vs. direct output current & ambient temperature, sine 180°

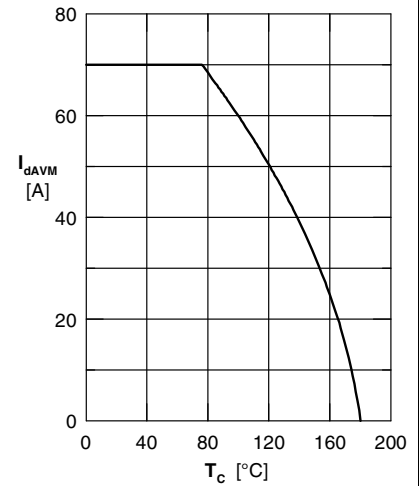

Fig. 5 Max. forward current versus case temperature, sine 180°

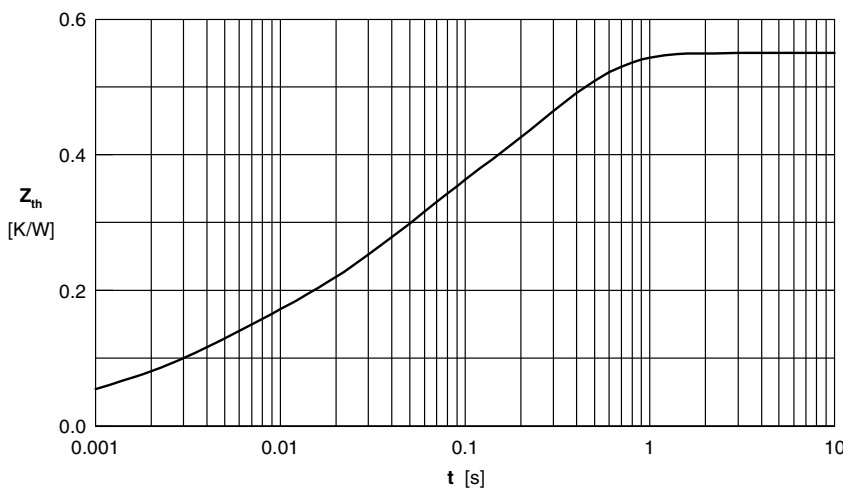

Fig. 6 Transient thermal impedance junction to case

i	R _i	τ _i
1	0.033	0.0006
2	0.095	0.0039
3	0.164	0.033
4	0.258	0.272