

Power Schottky rectifier

Features

- High current capability
- Avalanche rated
- Low forward voltage drop current
- High frequency operation

Description

Dual center tap schottky rectifier suited for high frequency switch mode power supplies.

Packaged in TO-247 and TO-220AB, this device provides desktop SMPS designers with a low forward voltage drop device, and reduced leakage current, with the objective of making the application compliant with environmental care standards, or suitable for 80+ requirements.

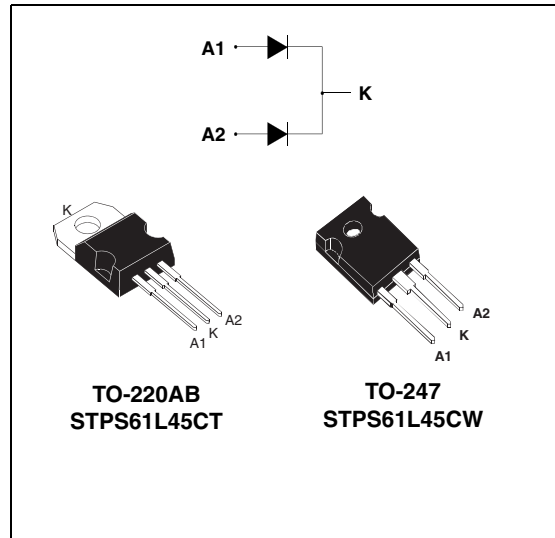

Table 1. Device summary

$I_{F(AV)}$	2 x 30 A
V_{RRM}	45 V
$T_j(max)$	150 °C
$V_F(typ)$	0.45 V

1 Characteristics

Table 2. Absolute ratings (limiting values per diode at 25 °C unless otherwise specified)

Symbol	Parameter		Value	Unit	
V _{RRM}	Repetitive peak reverse voltage		45	V	
I _{F(RMS)}	RMS forward current		60	A	
I _{F(AV)}	Average forward current $\delta = 0.5$	T _c = 120 °C T _c = 115 °C	Per diode Per device	30 60	A
I _{FSM}	Surge non repetitive forward current	t _p = 10 ms sinusoidal	500	A	
P _{ARM}	Repetitive peak avalanche power	t _p = 1 μ s T _j = 25 °C	10000	W	
T _{stg}	Storage temperature range		-65 to + 175	°C	
T _j	Maximum operating junction temperature ⁽¹⁾		150	°C	

1. $\frac{dP_{tot}}{dT_j} < \frac{1}{R_{th(j-a)}}$ condition to avoid runaway for a diode on its own heatsink

Table 3. Thermal resistances

Symbol	Parameter		Value	Unit
R _{th(j-c)}	Junction to case	Per diode Total	1.3 0.75	°C/W
R _{th(c)}	Coupling		0.2	°C/W

When the diodes 1 and 2 are used simultaneously :

$$\Delta T_j(\text{diode } 1) = P(\text{diode } 1) \times R_{th(j-c)}(\text{Per diode}) + P(\text{diode } 2) \times R_{th(c)}$$

Table 4. Static electrical characteristics (per diode)

Symbol	Parameter	Test Conditions		Min.	Typ.	Max.	Unit	
I _R ⁽¹⁾	Reverse leakage current	T _j = 25 °C	V _R = V _{RRM}			1.5	mA	
		T _j = 125 °C				190		400
V _F ⁽²⁾	Forward voltage drop	T _j = 25 °C	I _F = 5 A			0.35	V	
		T _j = 125 °C				0.23		
		T _j = 25 °C	I _F = 15 A			0.43		0.50
		T _j = 125 °C				0.34		0.40
		T _j = 25 °C	I _F = 30 A			0.50		0.56
		T _j = 125 °C				0.45		0.51

1. Pulse test: t_p = 5 ms, $\delta < 2\%$

2. Pulse test: t_p = 380 μ s, $\delta < 2\%$

To evaluate the conduction losses use the following equation:

$$P = 0.3 \times I_{F(AV)} + 0.007 \times I_{F(RMS)}^2$$

Figure 1. Conduction losses versus average forward current (per diode)

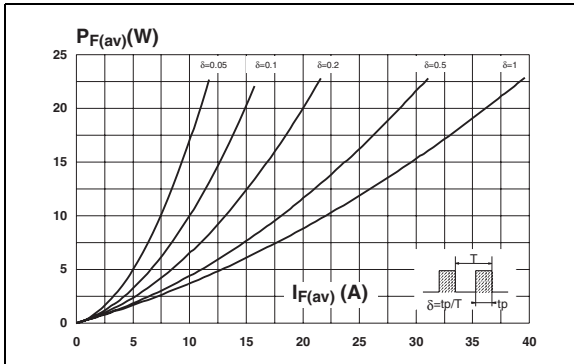

Figure 2. Average forward current versus ambient temperature ($\delta = 0.5$), (per diode)

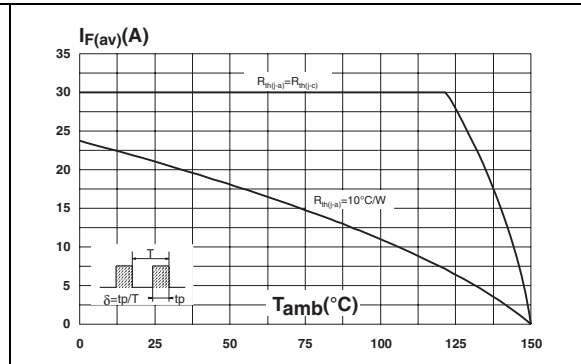

Figure 3. Normalized avalanche power derating versus pulse duration

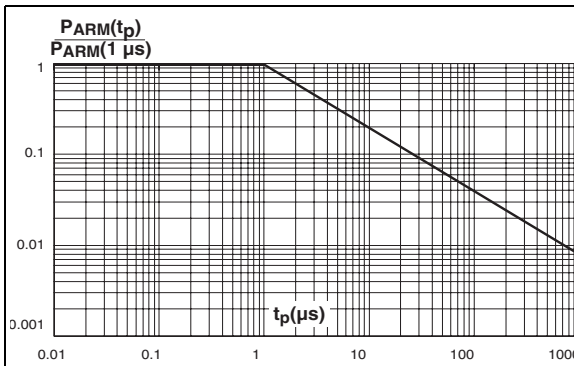

Figure 4. Normalized avalanche power derating versus junction temperature

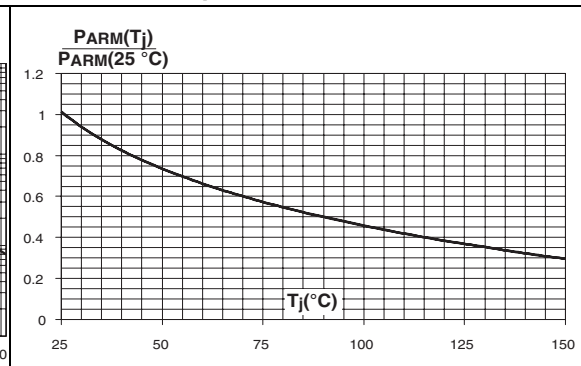

Figure 5. Non repetitive surge peak forward current versus overload duration (per diode)

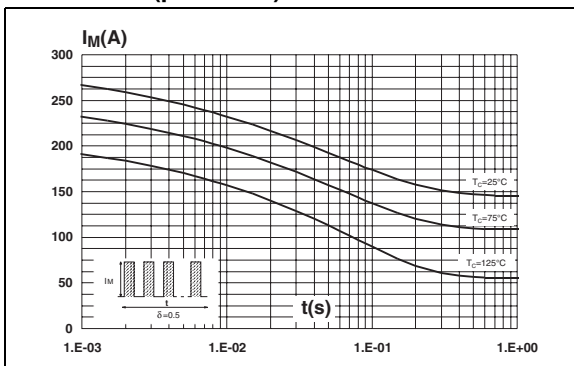

Figure 6. Relative variation of thermal impedance junction to case versus pulse duration

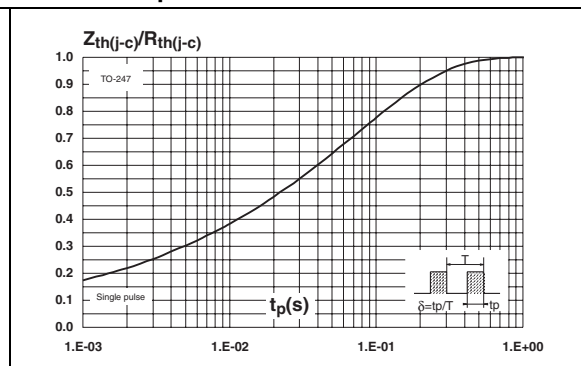

Figure 7. Reverse leakage current versus reverse voltage applied (typical values, per diode)

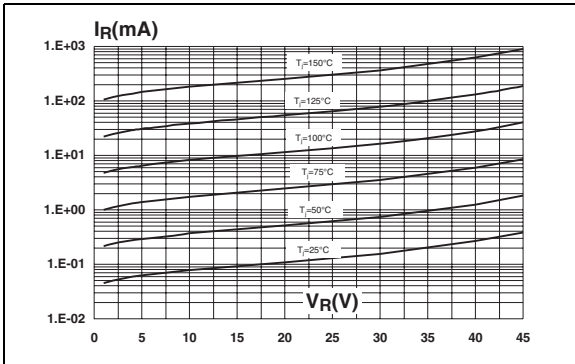

Figure 8. Junction capacitance versus reverse voltage applied (typical values, per diode)

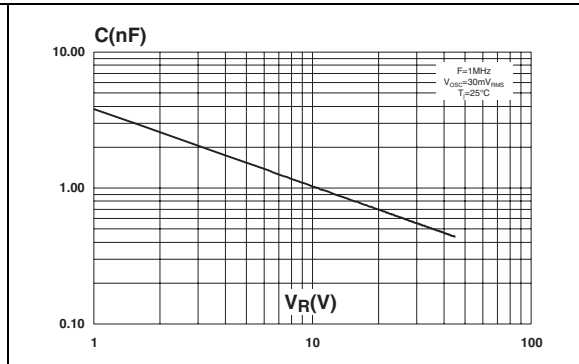
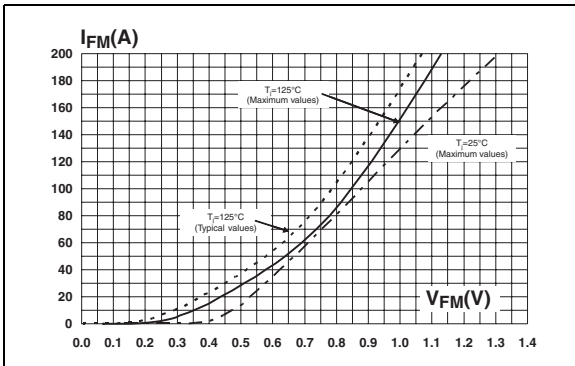

Figure 9. Forward voltage drop versus forward current (per diode)



2 Package information

- Epoxy meets UL94, V0
- Cooling method: C
- Recommended torque values for: TO-220AB 0.4 to 0.6 N·m
- Recommended torque values for: TO-247 0.9 to 1.2 N·m

In order to meet environmental requirements, ST (also) offers these devices in ECOPACK® packages. ECOPACK® packages are Lead-free. The category of second level Interconnect is marked on the package and on the inner box label, in compliance with JEDEC Standard JESD97. The maximum ratings related to soldering conditions are also marked on the inner box label.

ECOPACK is an ST trademark. ECOPACK specifications are available at: www.st.com.

Table 5. TO-220AB dimensions

Ref.	Dimensions			
	Millimeters		Inches	
	Min.	Max.	Min.	Max.
A	4.40	4.60	0.173	0.181
C	1.23	1.32	0.048	0.106
D	2.40	2.72	0.094	0.009
E	0.49	0.70	0.019	0.037
F	0.61	0.88	0.024	0.067
F1	1.14	1.70	0.044	0.024
F2	1.14	1.70	0.044	0.054
G	4.95	5.15	0.194	0.368
G1	2.40	2.70	0.094	0.409
H2	10	10.40	0.393	0.208
L2	16.4 typ		0.645 typ	
L4	13	14	0.511	0.055
L5	2.65	2.95	0.104	0.069
L6	15.25	15.75	0.600	0.126
L7	6.20	6.60	0.244	
L9	3.50	3.93	0.137	
M	2.6 typ.		0.102 typ.	
Diam.	3.75	3.85	0.147	0.151

Table 6. TO-247 dimensions

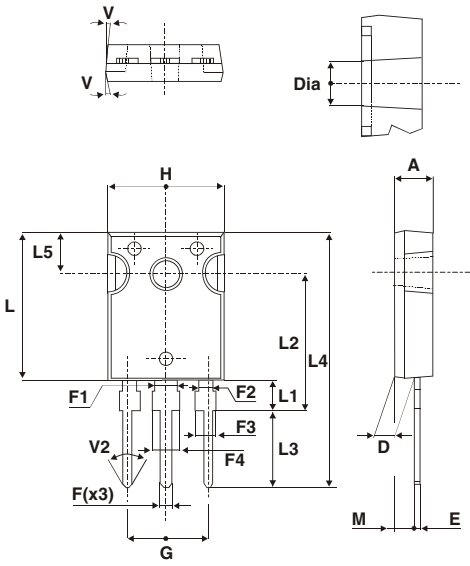

Ref.	Dimensions			
	Millimeters		Inches	
	Min.	Max.	Min.	Max.
A	4.85	5.15	0.191	0.203
D	2.20	2.60	0.086	0.102
E	0.40	0.80	0.015	0.031
F	1.00	1.40	0.039	0.055
F1	3.00 typ.		0.118 typ.	
F2	2.00 typ.		0.078 typ.	
F3	2.00	2.40	0.078	0.094
F4	3.00	3.40	0.118	0.133
G	10.90 typ.		0.429 typ.	
H	15.45	15.75	0.608	0.620
L	19.85	20.15	0.781	0.793
L1	3.70	4.30	0.145	0.169
L2	18.50 typ.		0.728 typ.	
L3	14.20	14.80	0.559	0.582
L4	34.60 typ.		1.362 typ.	
L5	5.50 typ.		0.216 typ.	
M	2.00	3.00	0.078	0.118
V	5° typ.		5° typ.	
V2	60° typ.		60° typ.	
Dia.	3.55	3.65	0.139	0.143

3 Ordering information

Table 7. Ordering information

Order code	Marking	Package	Weight	Base qty	Delivery mode
STPS61L45CW	STPS61L45CW	TO-247	4.4 g	30	Tube
STPS61L45CT	STPS61L45CT	TO-220AB	2.2 g	50	Tube

4 Revision history

Table 8. Document revision history

Date	Revision	Description of changes
14-Nov-2007	1	Initial release

Please Read Carefully:

Information in this document is provided solely in connection with ST products. STMicroelectronics NV and its subsidiaries ("ST") reserve the right to make changes, corrections, modifications or improvements, to this document, and the products and services described herein at any time, without notice.

All ST products are sold pursuant to ST's terms and conditions of sale.

Purchasers are solely responsible for the choice, selection and use of the ST products and services described herein, and ST assumes no liability whatsoever relating to the choice, selection or use of the ST products and services described herein.

No license, express or implied, by estoppel or otherwise, to any intellectual property rights is granted under this document. If any part of this document refers to any third party products or services it shall not be deemed a license grant by ST for the use of such third party products or services, or any intellectual property contained therein or considered as a warranty covering the use in any manner whatsoever of such third party products or services or any intellectual property contained therein.

UNLESS OTHERWISE SET FORTH IN ST'S TERMS AND CONDITIONS OF SALE ST DISCLAIMS ANY EXPRESS OR IMPLIED WARRANTY WITH RESPECT TO THE USE AND/OR SALE OF ST PRODUCTS INCLUDING WITHOUT LIMITATION IMPLIED WARRANTIES OF MERCHANTABILITY, FITNESS FOR A PARTICULAR PURPOSE (AND THEIR EQUIVALENTS UNDER THE LAWS OF ANY JURISDICTION), OR INFRINGEMENT OF ANY PATENT, COPYRIGHT OR OTHER INTELLECTUAL PROPERTY RIGHT.

UNLESS EXPRESSLY APPROVED IN WRITING BY AN AUTHORIZED ST REPRESENTATIVE, ST PRODUCTS ARE NOT RECOMMENDED, AUTHORIZED OR WARRANTED FOR USE IN MILITARY, AIR CRAFT, SPACE, LIFE SAVING, OR LIFE SUSTAINING APPLICATIONS, NOR IN PRODUCTS OR SYSTEMS WHERE FAILURE OR MALFUNCTION MAY RESULT IN PERSONAL INJURY, DEATH, OR SEVERE PROPERTY OR ENVIRONMENTAL DAMAGE. ST PRODUCTS WHICH ARE NOT SPECIFIED AS "AUTOMOTIVE GRADE" MAY ONLY BE USED IN AUTOMOTIVE APPLICATIONS AT USER'S OWN RISK.

Resale of ST products with provisions different from the statements and/or technical features set forth in this document shall immediately void any warranty granted by ST for the ST product or service described herein and shall not create or extend in any manner whatsoever, any liability of ST.

ST and the ST logo are trademarks or registered trademarks of ST in various countries.

Information in this document supersedes and replaces all information previously supplied.

The ST logo is a registered trademark of STMicroelectronics. All other names are the property of their respective owners.

© 2007 STMicroelectronics - All rights reserved

STMicroelectronics group of companies

Australia - Belgium - Brazil - Canada - China - Czech Republic - Finland - France - Germany - Hong Kong - India - Israel - Italy - Japan - Malaysia - Malta - Morocco - Singapore - Spain - Sweden - Switzerland - United Kingdom - United States of America

www.st.com