

Zener diode

RLZ36B

●Applications

Voltage regulation

●Features

- 1) Glass sealed envelope. (LLDS)
- 2) High reliability.

●Construction

Silicon planar

●Dimensions (Unit : mm)

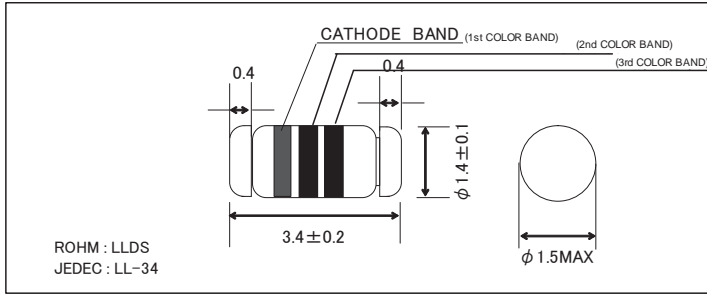

●Land size figure (Unit : mm)

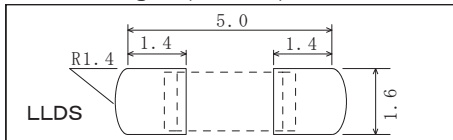

●Structure

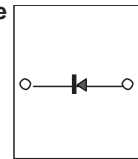

●Taping specifications (Unit : mm)

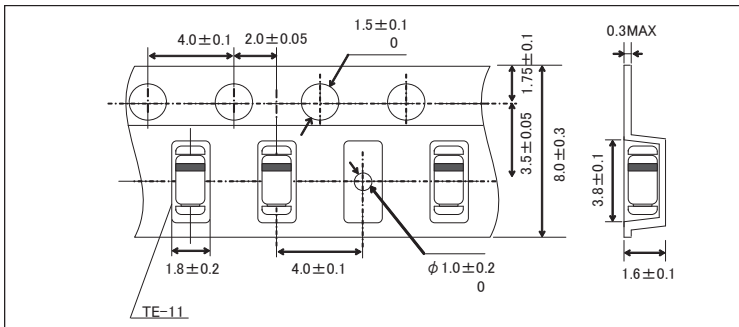

●Absolute maximum ratings (Ta=25°C)

| Parameter | Symbol | Limits | Unit |
|----------------------|------------------|-------------|------|
| Power dissipation | P | 500 | mW |
| Junction temperature | T _j | 175 | °C |
| Storage temperature | T _{stg} | -65 to +175 | °C |

Diodes

●Electrical voltage (Ta=25°C)

| TYP. | Symbol | | | | | | | | |
|----------|-----------------------|--------|--------|------------------------------|--------|------------------------------------|--------|-------------------------|-------|
| | Zener voltage : Vz(V) | | | Operating resistance : Zz(Ω) | | Rising operating resistance: Zz(Ω) | | Reverse current :IR(uA) | |
| | MIN. | MAX. | Iz(mA) | MAX. | Iz(mA) | MAX. | Iz(mA) | MAX. | VR(V) |
| RLZ 3.6B | 3.600 | 3.845 | 20.0 | 60 | 20.0 | 1000 | 1.0 | 10.0 | 1.0 |
| RLZ 3.9B | 3.890 | 4.160 | 20.0 | 50 | 20.0 | 1000 | 1.0 | 5.0 | 1.0 |
| RLZ 4.3B | 4.170 | 4.430 | 20.0 | 40 | 20.0 | 1000 | 1.0 | 5.0 | 1.0 |
| RLZ 4.7B | 4.550 | 4.800 | 20.0 | 25 | 20.0 | 900 | 1.0 | 5.0 | 1.0 |
| RLZ 5.1B | 4.940 | 5.200 | 20.0 | 20 | 20.0 | 800 | 1.0 | 5.0 | 1.5 |
| RLZ 5.6B | 5.450 | 5.730 | 20.0 | 13 | 20.0 | 500 | 1.0 | 5.0 | 2.5 |
| RLZ 6.2B | 5.960 | 6.270 | 20.0 | 10 | 20.0 | 300 | 1.0 | 5.0 | 3.0 |
| RLZ 6.8B | 6.490 | 6.830 | 20.0 | 8 | 20.0 | 150 | 0.5 | 2.0 | 3.5 |
| RLZ 7.5B | 7.070 | 7.450 | 20.0 | 8 | 20.0 | 120 | 0.5 | 0.5 | 4.0 |
| RLZ 8.2B | 7.780 | 8.190 | 20.0 | 8 | 20.0 | 120 | 0.5 | 0.5 | 5.0 |
| RLZ 9.1B | 8.570 | 9.010 | 20.0 | 8 | 20.0 | 120 | 0.5 | 0.5 | 6.0 |
| RLZ 10B | 9.410 | 9.900 | 20.0 | 8 | 20.0 | 120 | 0.5 | 0.2 | 7.0 |
| RLZ 11B | 10.500 | 11.050 | 10.0 | 10 | 10.0 | 120 | 0.5 | 0.2 | 8.0 |
| RLZ 12B | 11.440 | 12.030 | 10.0 | 12 | 10.0 | 110 | 0.5 | 0.2 | 9.0 |
| RLZ 13B | 12.550 | 13.210 | 10.0 | 14 | 10.0 | 110 | 0.5 | 0.2 | 10.0 |
| RLZ 15B | 13.890 | 14.620 | 10.0 | 16 | 10.0 | 110 | 0.5 | 0.2 | 11.0 |
| RLZ 16B | 15.250 | 16.040 | 10.0 | 18 | 10.0 | 150 | 0.5 | 0.2 | 12.0 |
| RLZ 18B | 16.820 | 17.700 | 10.0 | 23 | 10.0 | 150 | 0.5 | 0.2 | 13.0 |
| RLZ 20B | 18.630 | 19.590 | 10.0 | 28 | 10.0 | 200 | 0.5 | 0.2 | 15.0 |
| RLZ 22B | 20.640 | 21.710 | 5.0 | 30 | 5.0 | 200 | 0.5 | 0.2 | 17.0 |
| RLZ 24B | 22.610 | 23.770 | 5.0 | 35 | 5.0 | 200 | 0.5 | 0.2 | 19.0 |
| RLZ 27B | 24.970 | 26.260 | 5.0 | 45 | 5.0 | 250 | 0.5 | 0.2 | 21.0 |
| RLZ 30B | 27.700 | 29.130 | 5.0 | 55 | 5.0 | 250 | 0.5 | 0.2 | 23.0 |
| RLZ 33B | 30.320 | 31.880 | 5.0 | 65 | 5.0 | 250 | 0.5 | 0.2 | 25.0 |
| RLZ 36B | 32.790 | 34.490 | 5.0 | 75 | 5.0 | 250 | 0.5 | 0.2 | 27.0 |
| RLZ 39B | 35.360 | 37.190 | 5.0 | 85 | 5.0 | 250 | 0.5 | 0.2 | 30.0 |

(1)The zener voltage(Vz) is measured 40ms after power is supplied.

(2)The operating resistances(Zz,Zzk) are measured by superimposing a minute alternating current on the regulated current(Iz)

●Type No.

| TYPE | TYPE NO. | | TYPE | TYPE NO. | |
|----------|----------------|----------------|---------|----------------|----------------|
| | 1st COLOR BAND | 2nd COLOR BAND | | 1st COLOR BAND | 2nd COLOR BAND |
| RLZ 3.6B | 0 | 7 | RLZ 12B | 2 | 0 |
| RLZ 3.9B | 0 | 8 | RLZ 13B | 2 | 1 |
| RLZ 4.3B | 0 | 9 | RLZ 15B | 2 | 2 |
| RLZ 4.7B | 1 | 0 | RLZ 16B | 2 | 3 |
| RLZ 5.1B | 1 | 1 | RLZ 18B | 2 | 4 |
| RLZ 5.6B | 1 | 2 | RLZ 20B | 2 | 5 |
| RLZ 6.2B | 1 | 3 | RLZ 22B | 2 | 6 |
| RLZ 6.8B | 1 | 4 | RLZ 24B | 2 | 7 |
| RLZ 7.5B | 1 | 5 | RLZ 27B | 2 | 8 |
| RLZ 8.2B | 1 | 6 | RLZ 30B | 2 | 9 |
| RLZ 9.1B | 1 | 7 | RLZ 33B | 3 | 0 |
| RLZ 10B | 1 | 8 | RLZ 36B | 3 | 1 |
| RLZ 11B | 1 | 9 | RLZ 39B | 3 | 2 |

| 1st COLOR BAND | Color |
|----------------|--------|
| 0 | Black |
| 1 | Brown |
| 2 | Red |
| 3 | Orange |

| 2nd COLOR BAND | Color |
|----------------|--------|
| 0 | Black |
| 1 | Brown |
| 2 | Red |
| 3 | Orange |
| 4 | Yellow |
| 5 | Green |
| 6 | Blue |
| 7 | Purple |
| 8 | Gray |
| 9 | White |

| 3rd COLOR BAND | Color |
|----------------|--------|
| A , E | Yellow |
| B , F | Green |
| C , G | Blue |
| D | White |

Diodes

● Electrical characteristics (Ta=25°C)

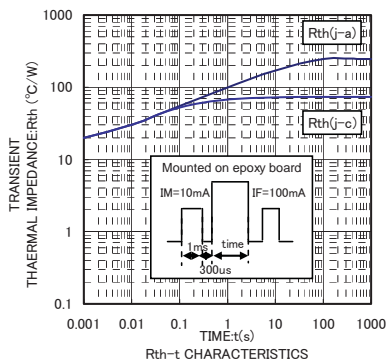
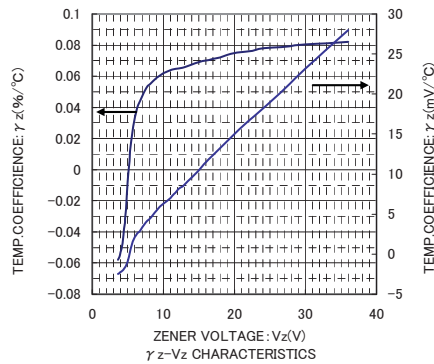
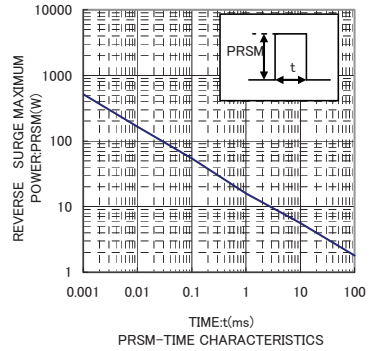
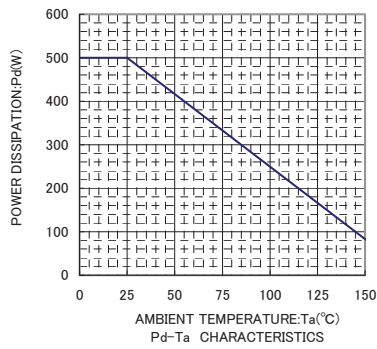
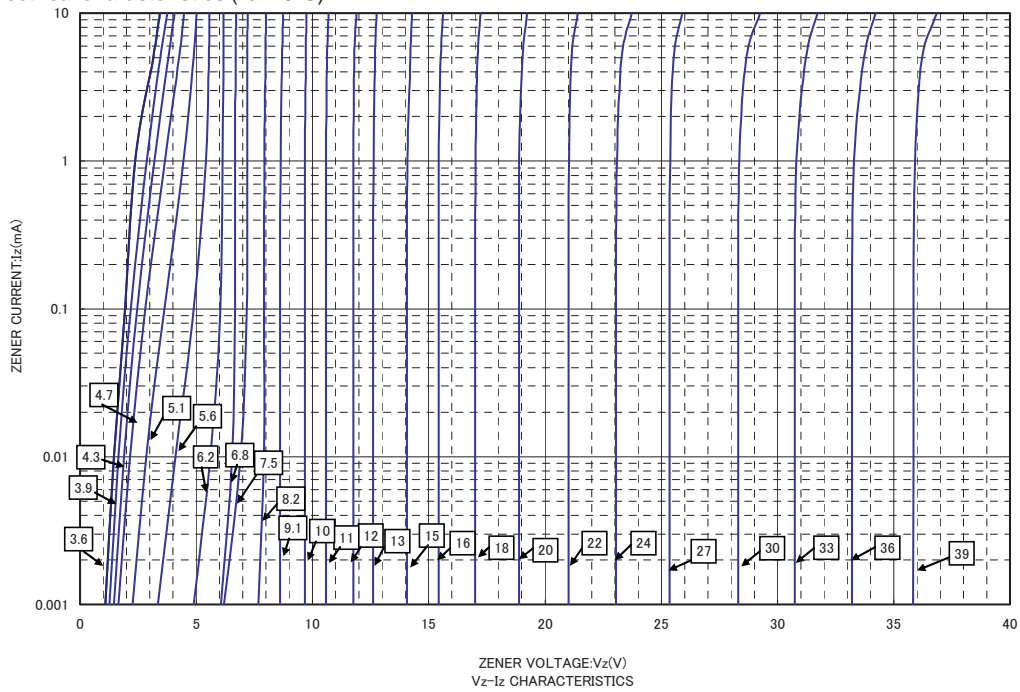

Diodes

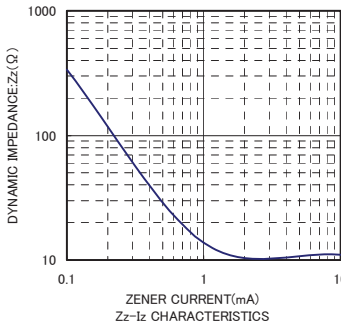
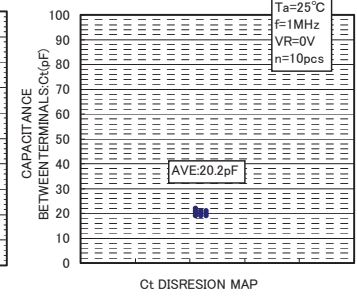
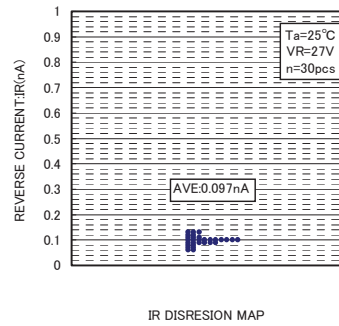
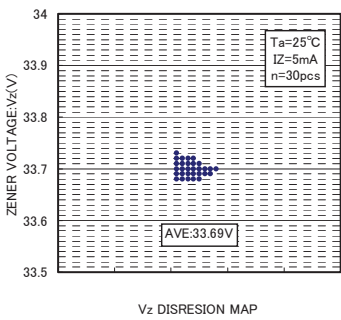
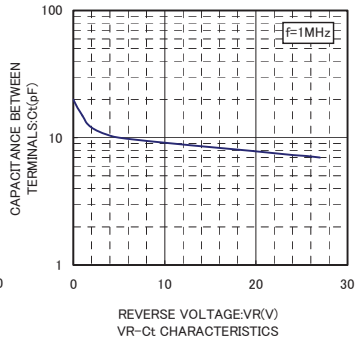
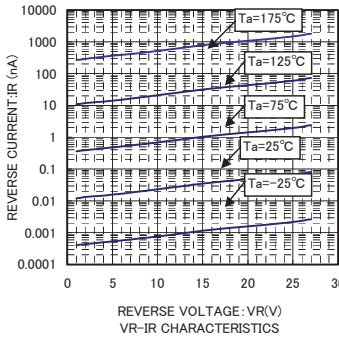
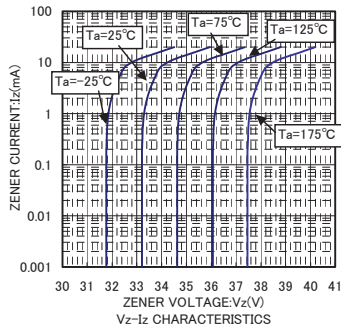

Notes

- No technical content pages of this document may be reproduced in any form or transmitted by any means without prior permission of ROHM CO.,LTD.
- The contents described herein are subject to change without notice. The specifications for the product described in this document are for reference only. Upon actual use, therefore, please request that specifications to be separately delivered.
- Application circuit diagrams and circuit constants contained herein are shown as examples of standard use and operation. Please pay careful attention to the peripheral conditions when designing circuits and deciding upon circuit constants in the set.
- Any data, including, but not limited to application circuit diagrams information, described herein are intended only as illustrations of such devices and not as the specifications for such devices. ROHM CO.,LTD. disclaims any warranty that any use of such devices shall be free from infringement of any third party's intellectual property rights or other proprietary rights, and further, assumes no liability of whatsoever nature in the event of any such infringement, or arising from or connected with or related to the use of such devices.
- Upon the sale of any such devices, other than for buyer's right to use such devices itself, resell or otherwise dispose of the same, no express or implied right or license to practice or commercially exploit any intellectual property rights or other proprietary rights owned or controlled by
- ROHM CO., LTD. is granted to any such buyer.
- Products listed in this document are no antiradiation design.

The products listed in this document are designed to be used with ordinary electronic equipment or devices (such as audio visual equipment, office-automation equipment, communications devices, electrical appliances and electronic toys).

Should you intend to use these products with equipment or devices which require an extremely high level of reliability and the malfunction of which would directly endanger human life (such as medical instruments, transportation equipment, aerospace machinery, nuclear-reactor controllers, fuel controllers and other safety devices), please be sure to consult with our sales representative in advance.

It is our top priority to supply products with the utmost quality and reliability. However, there is always a chance of failure due to unexpected factors. Therefore, please take into account the derating characteristics and allow for sufficient safety features, such as extra margin, anti-flammability, and fail-safe measures when designing in order to prevent possible accidents that may result in bodily harm or fire caused by component failure. ROHM cannot be held responsible for any damages arising from the use of the products under conditions out of the range of the specifications or due to non-compliance with the NOTES specified in this catalog.

Thank you for your accessing to ROHM product informations.

More detail product informations and catalogs are available, please contact your nearest sales office.

ROHM Customer Support System

THE AMERICAS / EUROPE / ASIA / JAPAN

www.rohm.com

Contact us : webmaster@rohm.co.jp