

# SMD Zener Diode

## CZRF52C2 Thru CZRF52C39 (RoHS Device)

Voltage 2 to 39 Volts  
Power 200 mWatts

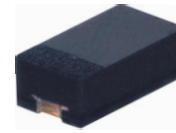

### Features

- 200mW Power Dissipation.
- High Voltages from 2 ~ 39 V.
- Designed for mounting on small surface.
- Extremely thin/leadless package.
- Pb free product.

### Mechanical data

- Case: 1005(2512) Standard package  
Molded plastic.
- Terminals: Gold plated, solderable per  
MIL-STD-750, method 2026.
- Polarity: Indicated by cathode band.
- Weight: 0.006 gram (approx.).

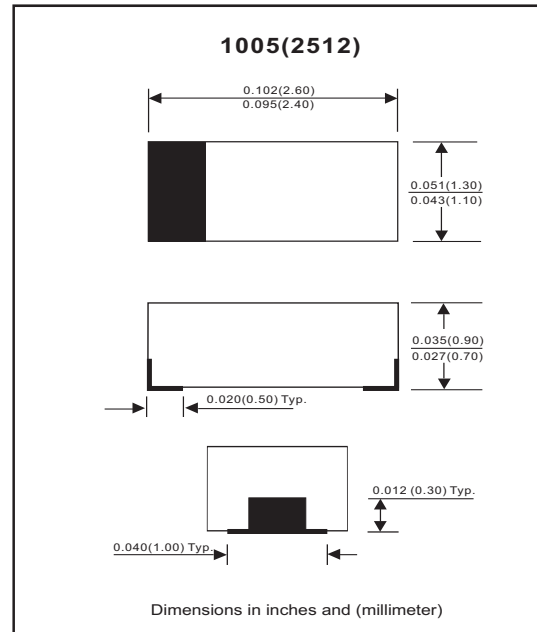

### Maximum Rating AND Electrical Characteristics

Parameter	Symbol	Value	Unit
Maximum Forward Voltage Drop at $I_F = 10 \text{ mA}$	$V_F$	0.9	V
Maximum Power Dissipation at 25 °C	$P_D$	200	mW
Forward current, surge peak 8.3 ms single half sine-wave superimposed on rate load (JEDEC method)	$I_{FSM}$	2.0	A
Peak ESD voltage capability (IEC 61000-4-2)	$V_{PV}$	8	kV
Operating Junction and Storage Temperature Range	$T_J$	-55 to +125	°C

## Electrical Characteristics(Ta = 25 °C)

Part Number	Marking Code	Zener Voltage			Operating resistance		Rising operating Resistance		Reverse current	
		Vz(V)			ZZT(Ohm)		ZZK(Ohm)		IR(μA)	
		Min	Max	Iz(mA)	Max	Iz(mA)	Max	Iz(mA)	Max	VR(V)
CZRF52C2	Z0	1.90	2.10	5	100	5	600	1	100	1
CZRF52C2V2	Z1	2.09	2.31	5	100	5	600	1	100	1
CZRF52C2V4	Z2	2.28	2.52	5	85	5	600	1	100	1
CZRF52C2V7	Z3	2.57	2.84	5	83	5	500	1	75	1
CZRF52C3	Z4	2.85	3.15	5	95	5	500	1	50	1
CZRF52C3V3	Z5	3.14	3.47	5	95	5	500	1	25	1
CZRF52C3V6	Z6	3.42	3.78	5	95	5	500	1	15	1
CZRF52C3V9	Z7	3.71	4.10	5	95	5	500	1	10	1
CZRF52C4V3	Z8	4.09	4.52	5	95	5	500	1	5	1
CZRF52C4V7	Z9	4.47	4.94	5	78	5	500	1	5	2
CZRF52C5V1	ZA	4.85	5.36	5	60	5	480	1	0.1	0.8
CZRF52C5V6	ZB	5.32	5.88	5	40	5	400	1	0.1	1
CZRF52C6V2	ZC	5.89	6.51	5	10	5	200	1	0.1	2
CZRF52C6V8	ZE	6.46	7.14	5	8	5	150	1	0.1	3
CZRF52C7V5	ZF	7.13	7.88	5	7	5	50	1	0.1	5
CZRF52C8V2	ZG	7.79	8.61	5	7	5	50	1	0.1	6
CZRF52C9V1	ZH	8.65	9.56	5	10	5	50	1	0.1	7
CZRF52C10	ZJ	9.50	10.50	5	15	5	70	1	0.1	7.5
CZRF52C11	ZK	10.45	11.55	5	20	5	70	1	0.1	8.5
CZRF52C12	ZM	11.40	12.60	5	20	5	90	1	0.1	9
CZRF52C13	ZN	12.35	13.65	5	25	5	110	1	0.1	10
CZRF52C15	ZP	14.25	15.75	5	30	5	110	1	0.1	11
CZRF52C16	ZQ	15.20	16.80	5	40	5	170	1	0.1	12
CZRF52C18	ZR	17.10	18.90	5	50	5	170	1	0.1	14
CZRF52C20	ZS	19.00	21.00	5	50	5	220	1	0.1	15
CZRF52C22	ZT	20.90	23.10	5	55	5	220	1	0.1	17
CZRF52C24	ZU	22.80	25.20	5	80	5	220	1	0.1	18
CZRF52C27	ZV	25.65	28.35	5	80	5	250	1	0.1	20
CZRF52C30	ZW	28.50	31.50	5	80	5	250	1	0.1	23
CZRF52C33	ZX	31.35	34.65	5	80	5	250	1	0.1	25
CZRF52C36	ZY	34.20	37.80	5	90	5	250	1	0.1	27
CZRF52C39	ZZ	37.05	40.95	5	90	5	300	1	0.1	29

## RATING AND CHARACTERISTIC CURVES (CZRF52C2 Thru CZRF52C39)

Fig.1 TEMPERATURE COEFFICIENTS

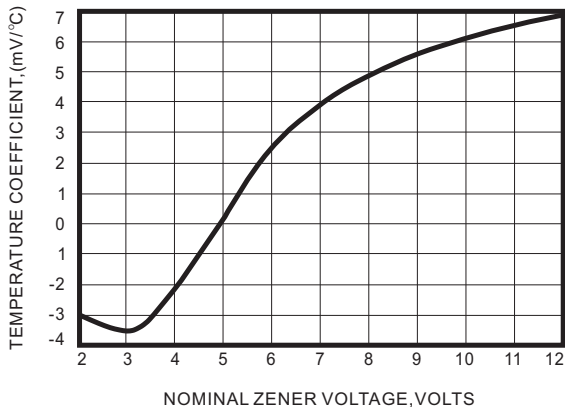

Fig.2 TEMPERATURE COEFFICIENTS

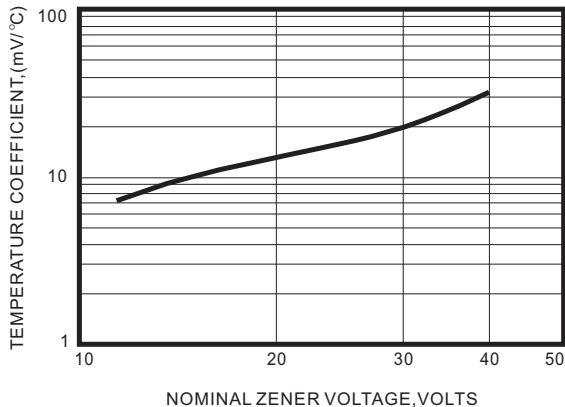

Fig.3 EFFECT OF ZENER VOLTAGE ON ZENER IMPEDANCE

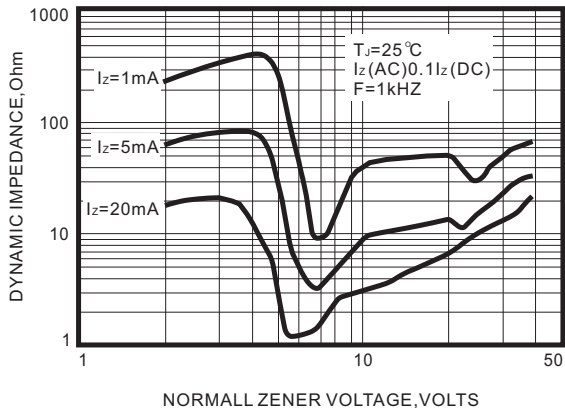

Fig.4 TYPICAL FORWARD VOLTAGE

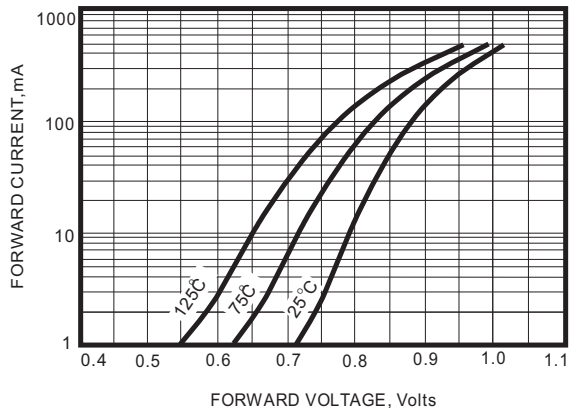

Fig.5 TYPICAL LEAKAGE CURRENT

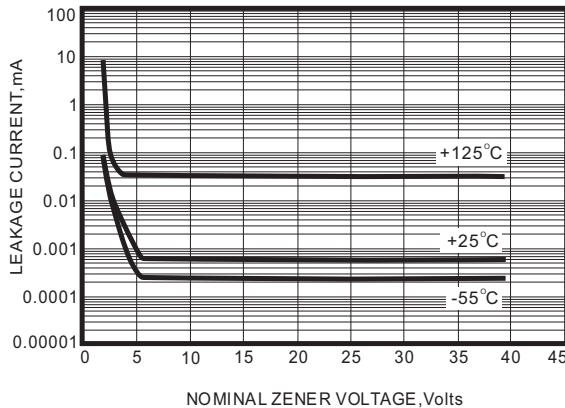
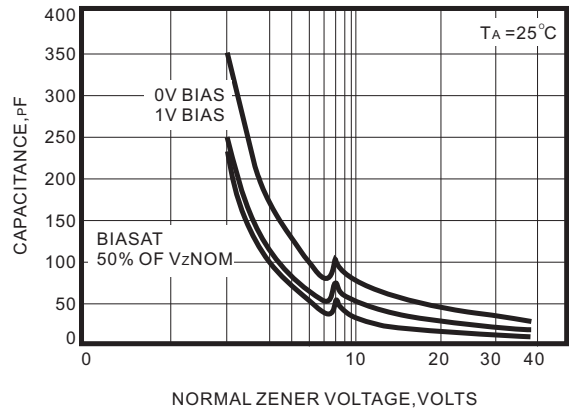

Fig.6 TYPICAL CAPACITANCE



## RATING AND CHARACTERISTIC CURVES (CZRF52C2 Thru CZRF52C39)

Fig.7 ZENER VOLTAGE VERSUS ZENER CURRENT

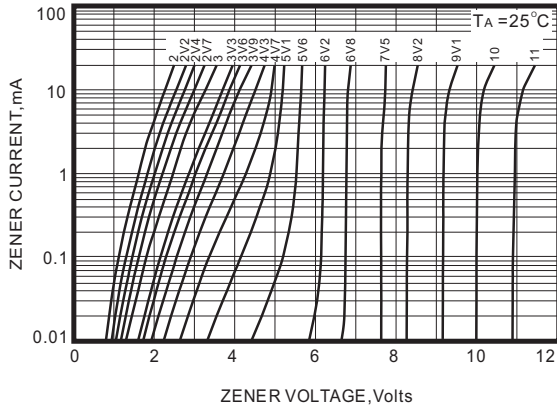

Fig.8 ZENER VOLTAGE VERSUS ZENER CURRENT

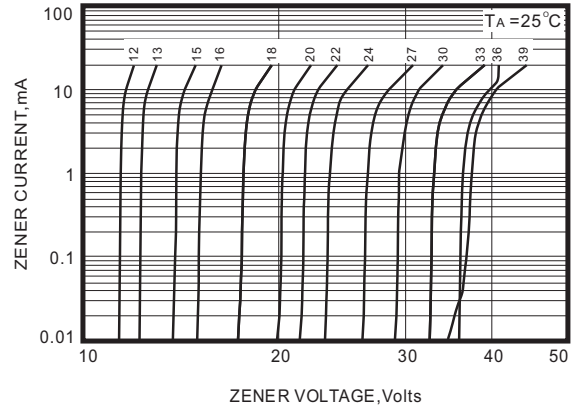
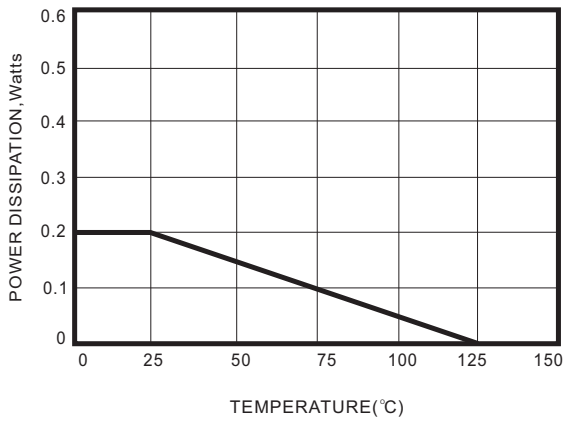
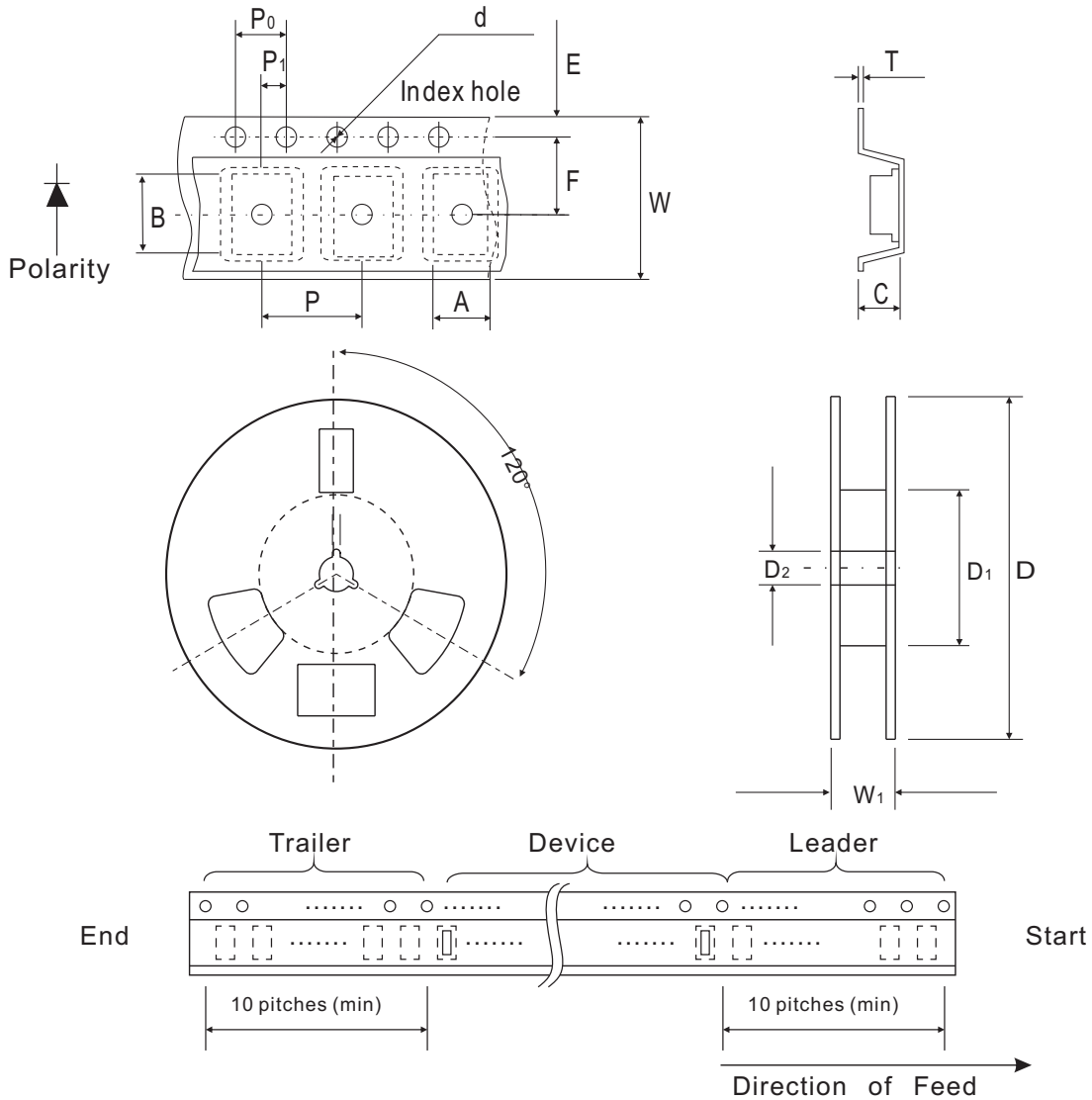

Fig.9 STEADY STATE POWER DERATING



## Reel Taping Specification



F/1005	SYMBOL	A	B	C	d	D	D <sub>1</sub>	D <sub>2</sub>
	(mm)	1.55 ± 0.10	2.65 ± 0.10	1.05 ± 0.10	1.55 ± 0.05	178 ± 1	60.0 MIN.	13.0 ± 0.20
	(inch)	0.061 ± 0.004	0.104 ± 0.004	0.041 ± 0.004	0.061 ± 0.002	7.008 ± 0.04	2.362 MIN.	0.512 ± 0.008

F/1005	SYMBOL	E	F	P	P <sub>0</sub>	P <sub>1</sub>	T	W	W <sub>1</sub>
	(mm)	1.75 ± 0.10	3.50 ± 0.05	4.00 ± 0.10	4.00 ± 0.10	2.00 ± 0.05	0.23 ± 0.05	8.00 ± 0.20	13.5 MAX.
	(inch)	0.069 ± 0.004	0.138 ± 0.002	0.157 ± 0.004	0.157 ± 0.004	0.079 ± 0.004	0.009 ± 0.002	0.315 ± 0.008	0.531 MAX.

## Suggested PAD Layout

SIZE	F/1005	
	(mm)	(inch)
A	2.10	0.083
B	1.20	0.047
C	1.20	0.047
D	3.30	0.130
E	0.90	0.035

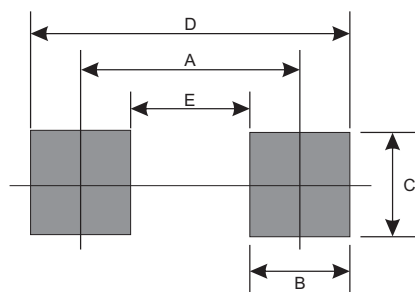

## Standard Package

Case Type	Qty per Reel	Reel Size
	(Pcs)	(inch)
F/1005	4000	7