

Features

- Ultra-Small Surface Mount Package
- Planar Die Construction
- General Purpose
- Ideally Suited for Automated Assembly Processes
- **Lead Free/RoHS Compliant (Note 2)**
- **"Green" Device (Note 3 and 4)**

Mechanical Data

- Case: SOT-523
- Case Material: Molded Plastic. UL Flammability Classification Rating 94V-0
- Moisture Sensitivity: Level 1 per J-STD-020D
- Terminals: Solderable per MIL-STD-202, Method 208
- Lead Free Plating (Matte Tin Finish annealed over Alloy 42 leadframe).
- Polarity: See Diagram
- Marking Information: See Page 4
- Ordering Information: See Page 4
- Weight: 0.002 grams (approximate)



Top View

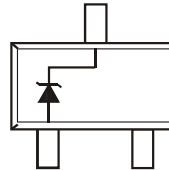

Device Schematic

Maximum Ratings @ $T_A = 25^\circ\text{C}$ unless otherwise specified

Characteristic	Symbol	Value	Unit
Zener Current (See Table on page 2)	—	—	—
Forward Voltage @ $I_F = 10\text{mA}$	V_F	0.9	V

Thermal Characteristics

Characteristic	Symbol	Value	Unit
Power Dissipation (Note 1)	P_D	150	mW
Thermal Resistance, Junction to Ambient (Note 1)	$R_{\theta JA}$	833	$^\circ\text{C/W}$
Operating and Storage Temperature Range	T_J, T_{STG}	-65 to +150	$^\circ\text{C}$

- Notes:
1. Device mounted on FR-4 PC board with recommended pad layout at <http://www.diodes.com/datasheets/ap02001.pdf>.
 2. No purposefully added lead.
 3. Diodes Inc.'s "Green" policy can be found on our website at http://www.diodes.com/products/lead_free/index.php.
 4. Product manufactured with Date Code UO (week 40, 2007) and newer are built with Green Molding Compound. Product manufactured prior to Date Code UO are built with Non-Green Molding Compound and may contain Halogens or Sb2O3 Fire Retardants.

Electrical Characteristics @_{T_A} = 25°C unless otherwise specified

Type Number	Marking Code	Zener Voltage Range (Note 5)			Test Current	Maximum Zener Impedance (Note 6)		Maximum Reverse Leakage Current (Note 5)	
		V _Z @ I _{ZT}				I _{ZT}	Z _{ZT} @ I _{ZT}	Z _{ZK} @ I _{ZK} = 0.25mA	I _R
		Nom (V)	Min (V)	Max (V)	mA				
MMBZ5221BT	KC1	2.4	2.28	2.52	20	30	1200	100	1.0
MMBZ5223BT	KC3	2.7	2.57	2.84	20	30	1300	75	1.0
MMBZ5225BT	KC5	3.0	2.85	3.15	20	30	1600	50	1.0
MMBZ5226BT	KG1	3.3	3.14	3.47	20	28	1600	25	1.0
MMBZ5227BT	KG2	3.6	3.42	3.78	20	24	1700	15	1.0
MMBZ5228BT	KG3	3.9	3.71	4.10	20	23	1900	10	1.0
MMBZ5229BT	KG4	4.3	4.09	4.52	20	22	2000	5.0	1.0
MMBZ5230BT	KG5	4.7	4.47	4.94	20	19	1900	5.0	2.0
MMBZ5231BT	KE1	5.1	4.85	5.36	20	17	1600	5.0	2.0
MMBZ5232BT	KE2	5.6	5.32	5.88	20	11	1600	5.0	3.0
MMBZ5234BT	KE4	6.2	5.89	6.51	20	7.0	1000	5.0	4.0
MMBZ5235BT	KE5	6.8	6.46	7.14	20	5.0	750	3.0	5.0
MMBZ5236BT	KF1	7.5	7.13	7.88	20	6.0	500	3.0	6.0
MMBZ5237BT	KF2	8.2	7.79	8.61	20	8.0	500	3.0	6.5
MMBZ5239BT	KF4	9.1	8.65	9.56	20	10	600	3.0	7.0
MMBZ5240BT	KF5	10	9.50	10.50	20	17	600	3.0	8.0
MMBZ5241BT	KH1	11	10.45	11.55	20	22	600	2.0	8.4
MMBZ5242BT	KH2	12	11.40	12.60	20	30	600	1.0	9.1
MMBZ5243BT	KH3	13	12.35	13.65	9.5	13	600	0.5	9.9
MMBZ5245BT	KH5	15	14.25	15.75	8.5	16	600	0.1	11
MMBZ5246BT	KJ1	16	15.20	16.80	7.8	17	600	0.1	12
MMBZ5248BT	KJ3	18	17.10	18.90	7.0	21	600	0.1	14
MMBZ5250BT	KJ5	20	19.00	21.00	6.2	25	600	0.1	15
MMBZ5251BT	KK1	22	20.90	23.10	5.6	29	600	0.1	17
MMBZ5252BT	KK2	24	22.80	25.20	5.2	33	600	0.1	18
MMBZ5254BT	KK4	27	25.65	28.35	5.0	41	600	0.1	21
MMBZ5255BT	KK5	28	26.60	29.40	4.5	44	600	0.1	21
MMBZ5256BT	KM1	30	28.50	31.50	4.2	49	600	0.1	23
MMBZ5257BT	KM2	33	31.35	34.65	3.8	58	700	0.1	25
MMBZ5258BT	KM3	36	34.20	37.80	3.4	70	700	0.1	27
MMBZ5259BT	KM4	39	37.05	40.95	3.2	80	800	0.1	30

Notes: 5. Short duration pulse test used to minimize self-heating effect.
6. f = 1KHz.

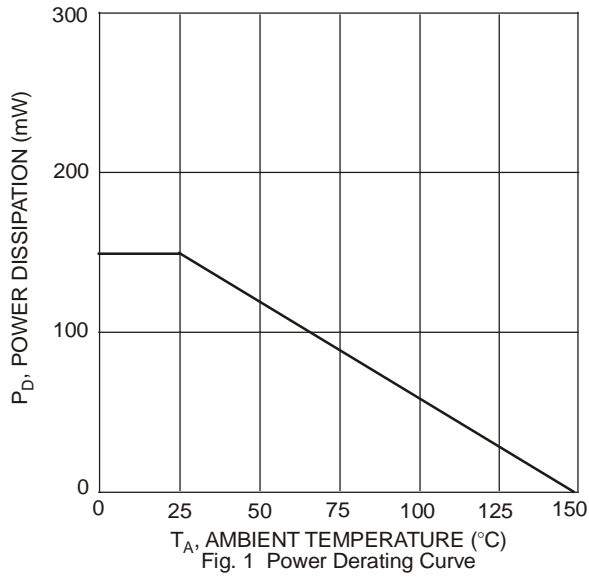

Fig. 1 Power Derating Curve

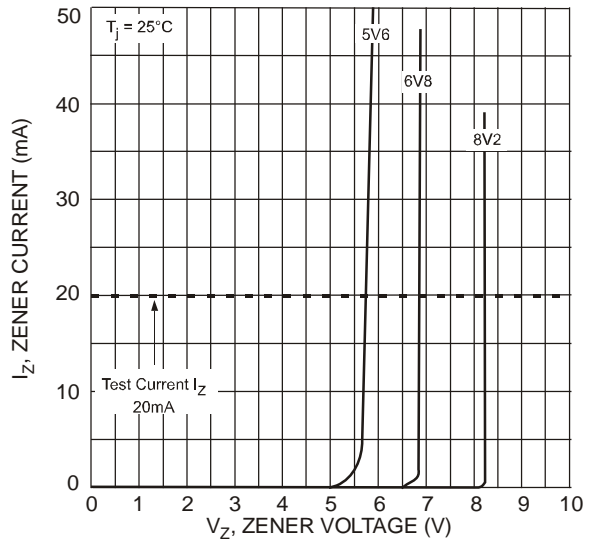

Fig. 2 Typical Zener Breakdown Characteristics

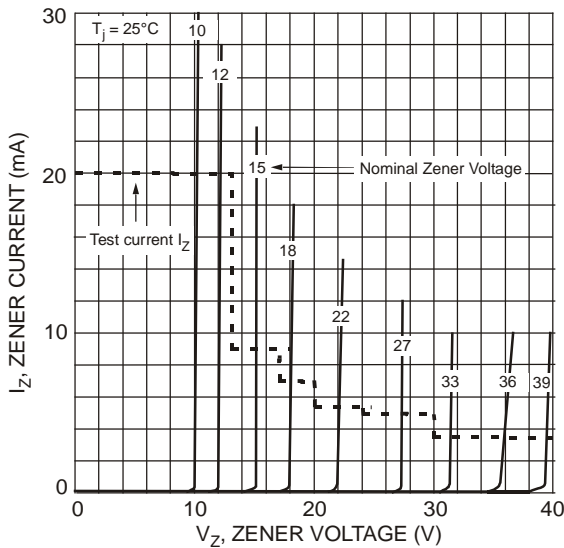

Fig. 3 Typical Zener Breakdown Characteristics

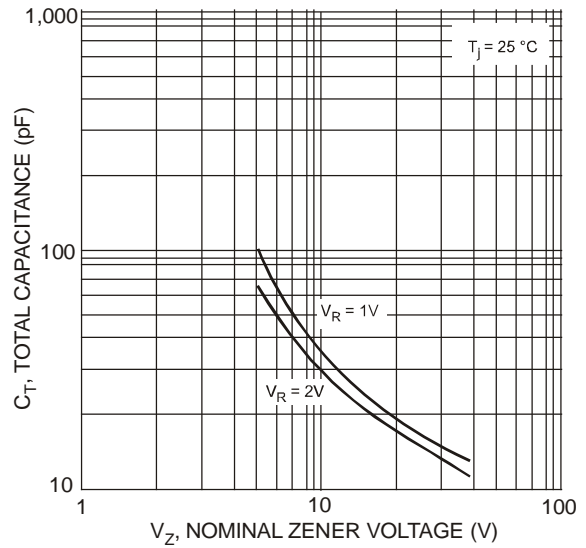

Fig. 4 Typical Total Capacitance vs. Nominal Zener Voltage

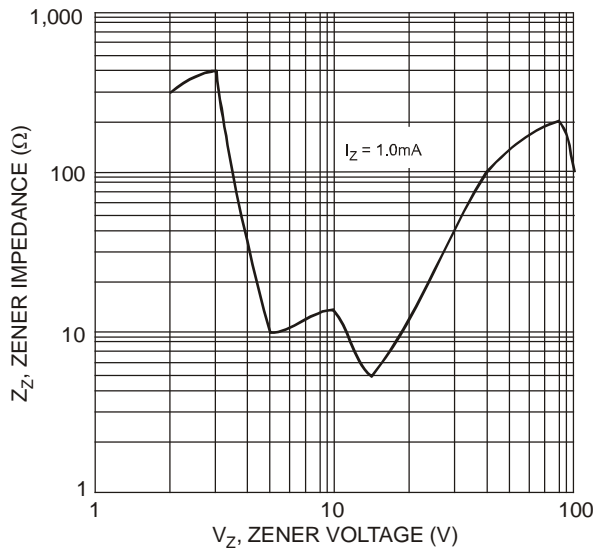

Fig. 5 Typical Zener Impedance Characteristics

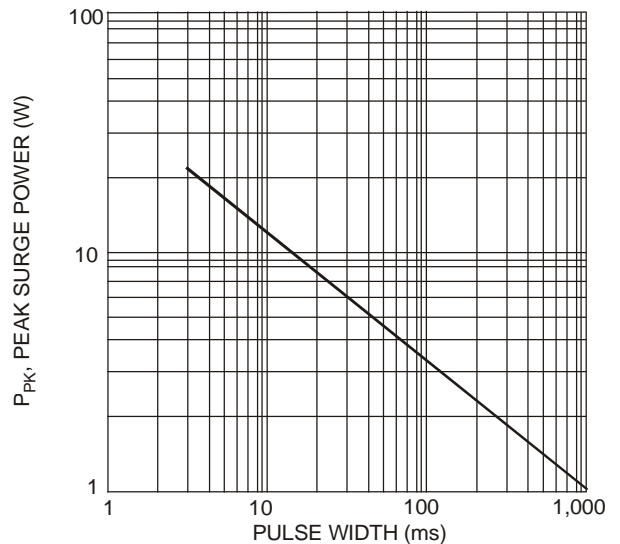

Fig. 6 Maximum Non-repetitive Surge Power

Ordering Information (Note 7)

Device	Packaging	Shipping
(Type Number)-7-F	SOT-523	3000/Tape & Reel

* Add "-7-F" to the appropriate type number in from Electrical Characteristics Table, example: 6.2V Zener = MMBZ5234BTS-7-F.

Notes: 7. For packaging details, go to our website at <http://www.diodes.com/datasheets/ap02007.pdf>.

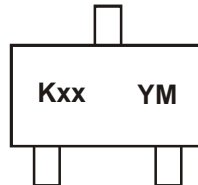
Marking Information

Kxx = Product Type Marking Code
(See Electrical Characteristics Table)

YM = Date Code Marking

Y = Year (ex: N = 2002)

M = Month (ex: 9 = September)

Date Code Key

Year	2002	2003	2004	2005	2006	2007	2008	2009	2010	2111	2012	2013	2014	2015
Code	N	P	R	S	T	U	V	W	X	Y	Z	A	B	C

Month	Jan	Feb	Mar	Apr	May	Jun	Jul	Aug	Sep	Oct	Nov	Dec
Code	1	2	3	4	5	6	7	8	9	O	N	D

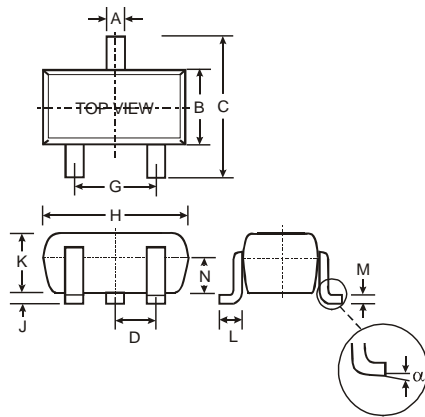
Package Outline Dimensions

SOT-523			
Dim	Min	Max	Typ
A	0.15	0.30	0.22
B	0.75	0.85	0.80
C	1.45	1.75	1.60
D	—	—	0.50
G	0.90	1.10	1.00
H	1.50	1.70	1.60
J	0.00	0.10	0.05
K	0.60	0.80	0.75
L	0.10	0.30	0.22
M	0.10	0.20	0.12
N	0.45	0.65	0.50
α	0°	8°	—
All Dimensions in mm			

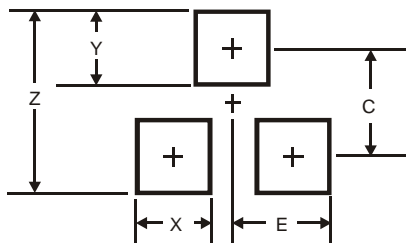
Suggested Pad Layout

Dimensions	Value (in mm)
Z	1.8
X	0.4
Y	0.51
C	1.3
E	0.7

IMPORTANT NOTICE

Diodes Incorporated and its subsidiaries reserve the right to make modifications, enhancements, improvements, corrections or other changes without further notice to any product herein. Diodes Incorporated does not assume any liability arising out of the application or use of any product described herein; neither does it convey any license under its patent rights, nor the rights of others. The user of products in such applications shall assume all risks of such use and will agree to hold Diodes Incorporated and all the companies whose products are represented on our website, harmless against all damages.

LIFE SUPPORT

Diodes Incorporated products are not authorized for use as critical components in life support devices or systems without the expressed written approval of the President of Diodes Incorporated.