

Features

- Very Sharp Breakdown Characteristics
- Very Tight Tolerance on V_Z
- Ideally Suited for Automated Assembly Processes
- Very Low Leakage Current
- **Lead, Halogen and Antimony Free, RoHS Compliant "Green" Device (Notes 2 and 3)**

Mechanical Data

- Case: SOD-323
- Case Material: Molded Plastic. UL Flammability Classification Rating 94V-0
- Moisture Sensitivity: Level 1 per J-STD-020D
- Terminals: Finish - Matte Tin annealed over Alloy 42 leadframe. Solderable per MIL-STD-202, Method 208
- Polarity: Cathode Band
- Marking Information: See Page 6
- Ordering Information: See Page 6
- Weight: 0.004 grams (approximate)



Top View

Maximum Ratings @ $T_A = 25^\circ\text{C}$ unless otherwise specified

Characteristic	Symbol	Value	Unit
Forward Voltage @ $I_F = 10\text{mA}$	V_F	0.9	V

Thermal Characteristics

Characteristic	Symbol	Value	Unit
Power Dissipation (Note 1)	P_D	200	mW
Thermal Resistance, Junction to Ambient Air (Note 1)	$R_{\theta JA}$	625	$^\circ\text{C/W}$
Operating and Storage Temperature Range	T_J, T_{STG}	-65 to +150	$^\circ\text{C}$

- Notes:
1. Device mounted on FR-4 PC board with recommended pad layout which can be found on our website at <http://www.diodes.com/datasheets/ap02001.pdf>
 2. No purposefully added lead. Halogen and Antimony Free.
 3. Product manufactured with Data Code V9 (week 33, 2008) and newer are built with Green Molding Compound. Product manufactured prior to Date Code V9 are built with Non-Green Molding Compound and may contain Halogens or Sb_2O_3 Fire Retardants.

Electrical Characteristics @ $T_A = 25^\circ\text{C}$ unless otherwise specified

Type Number	Marking Code	Zener Voltage Range (Notes 4, 5)			Maximum Zener Impedance (Note 6)			Maximum Reverse Current (Note 7)	
		$V_Z @ I_{ZT}$		I_{ZT}	$Z_{ZT} @ I_{ZT}$	$Z_{ZK} @ I_{ZK}$	I_{ZK}	I_R	@ V_R
		Min (V)	Max (V)	mA	Ω	Ω	mA	μA	V
DDZ5V1BS	KM	4.94	5.20	20	17	480	1	5	1.5
DDZ5V6BS	KN	5.45	5.73	20	11	400	1	0.5	2.5
DDZ6V2BS	KO	5.96	6.27	20	7	150	1	0.5	4.0
DDZ6V8CS	YP	6.66	7.01	20	5	150	0.5	0.1	5.0
DDZ7V5CS	YQ	7.29	7.67	20	6	120	0.5	0.1	6.0
DDZ8V2CS	YR	8.03	8.45	20	8	120	0.5	0.1	6.5
DDZ9V1CS	YS	8.83	9.30	20	8	120	0.5	0.1	7.0
DDZ10CS	YT	9.70	10.20	20	8	120	0.5	0.1	8.0
DDZ11CS	YU	10.82	11.38	10	10	120	0.5	0.1	8.4
DDZ12CS	YV	11.74	12.35	10	12	110	0.5	0.1	9.1
DDZ13BS	KW	12.55	13.21	10	14	110	0.5	0.1	10.0
DDZ14S	GX	13.65	14.35	10	16	110	0.5	0.05	11.0
DDZ15S	GY	14.80	15.57	10	18	150	0.5	0.05	12.0
DDZ16S	YY	15.69	16.51	10	18	150	0.5	0.05	12.0
DDZ18CS	YZ	17.42	18.33	10	23	150	0.5	0.05	14.0
DDZ20CS	PJ	19.23	20.22	10	28	200	0.5	0.05	15.0
DDZ22DS	2K	21.52	22.63	5	30	200	0.5	0.05	17.0
DDZ24CS	PL	23.12	24.31	5	35	200	0.5	0.05	19.0
DDZ27DS	2M	26.29	27.64	5	45	250	0.5	0.05	21.0
DDZ30DS	2N	29.02	30.51	5	55	250	0.5	0.05	23.0
DDZ33S	RP	32.14	33.79	5	75	250	0.5	0.05	27.0
DDZ36S	ZQ	35.36	37.19	5	85	250	0.5	0.05	30.0
DDZ39FS	5Q	38.02	39.98	5	85	250	0.5	0.05	30.0
DDZ43S	ZR	42.14	43.86	5	90	—	—	0.05	33.0

- Notes:
- The Zener voltage is measured 40ms after power is supplied.
 - For inquiries on tighter tolerances, or alternate nominal zener voltages, please contact your Diodes Inc. sales representative for availability and minimum order details.
 - $f = 1\text{kHz}$.
 - Short duration pulse test used to minimize self-heating effect.

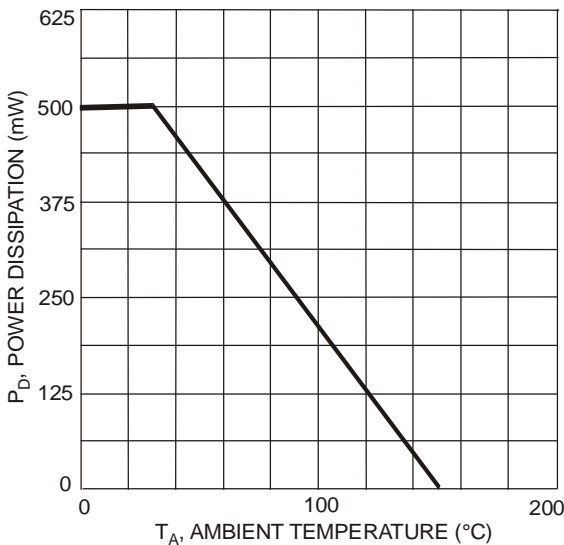

Fig. 1 Power Derating Curve

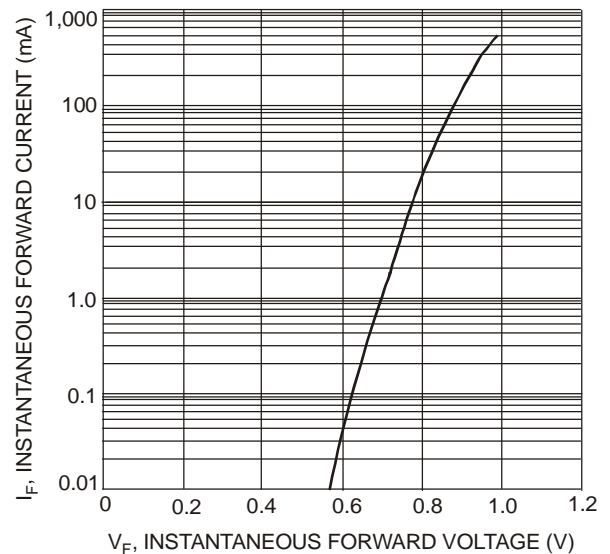

Fig. 2 Typical Forward Characteristics

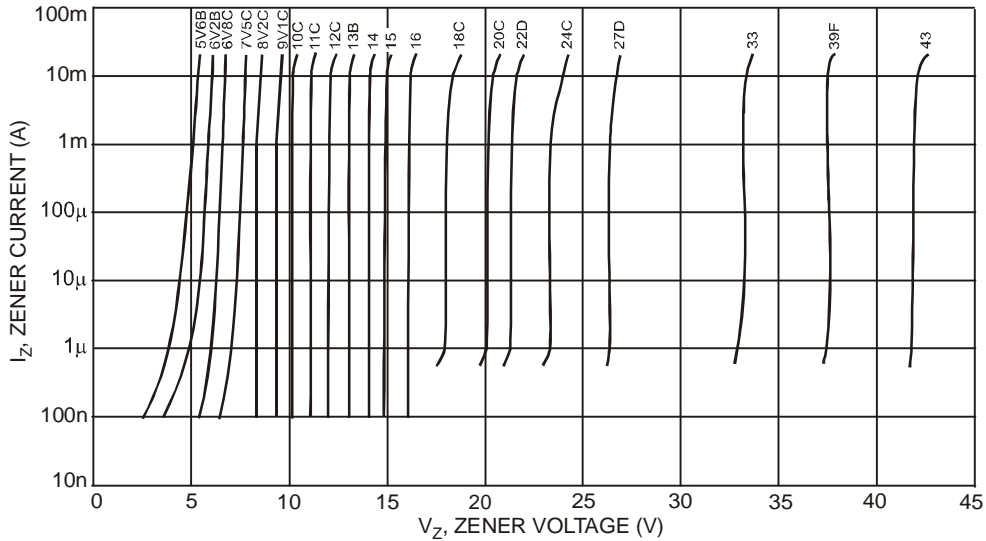

Fig. 3 Typical Zener Breakdown Characteristics

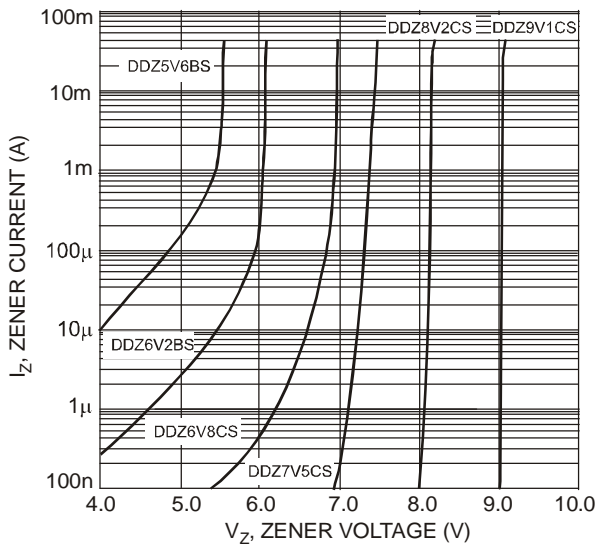

Fig. 4 Typical Zener Breakdown Characteristics, DDZ5V6BS - DDZ9V1CS

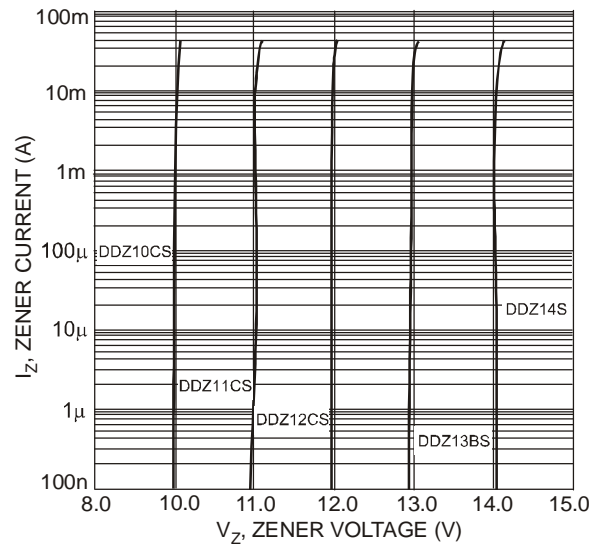

Fig. 5 Typical Zener Breakdown Characteristics, DDZ10CS - DDZ14S

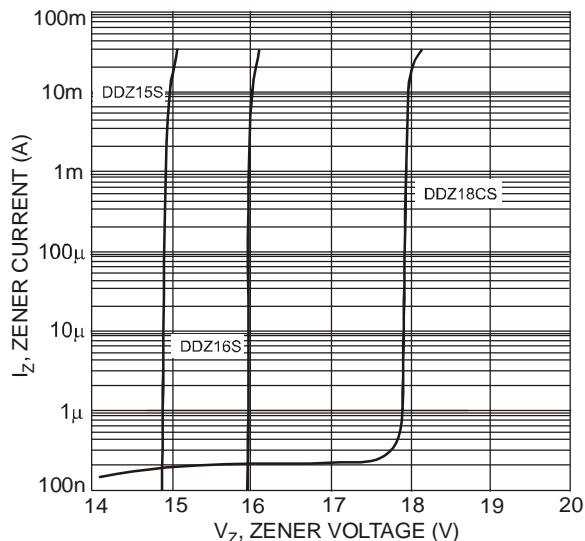

Fig. 6 Typical Zener Breakdown Characteristics, DDZ15S - DDZ18CS

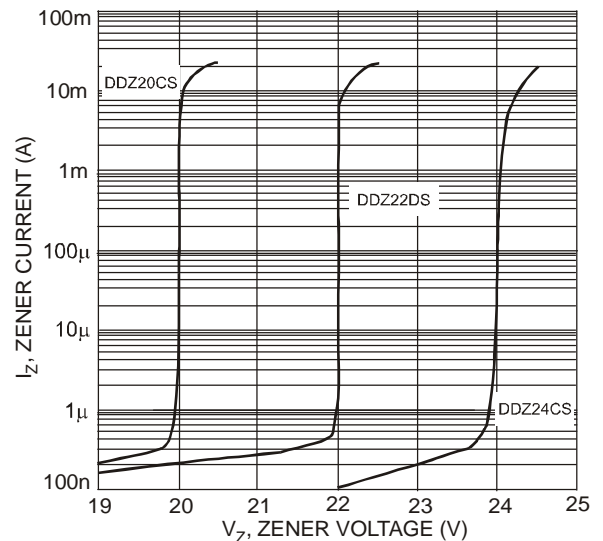

Fig. 7 Typical Zener Breakdown Characteristics, DDZ20CS - DDZ24CS

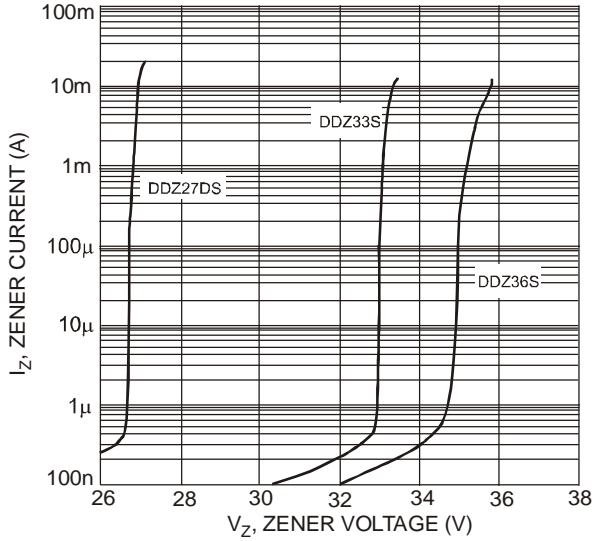

Fig. 8 Typical Zener Breakdown Characteristics, DDZ27DS - DDZ36S

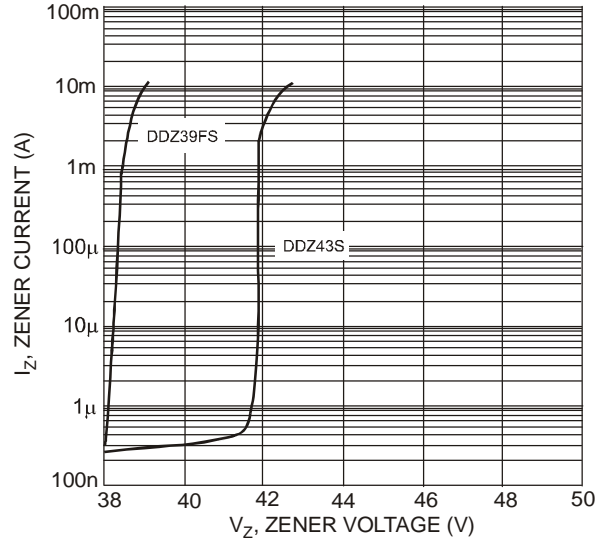

Fig. 9 Typical Zener Breakdown Characteristics, DDZ39FS - DDZ43S

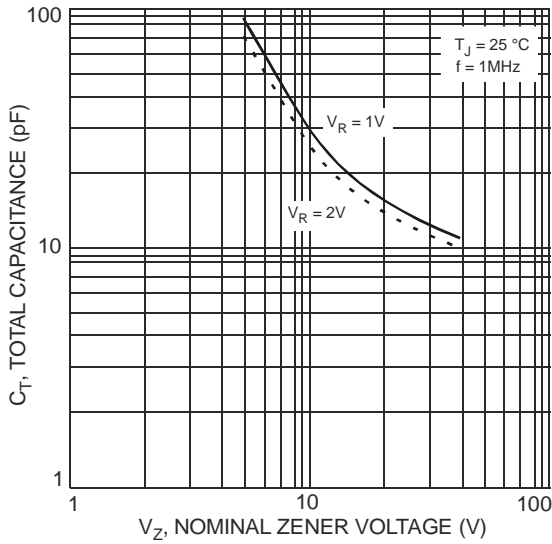

Fig. 10 Typical Total Capacitance vs. Nominal Zener Voltage

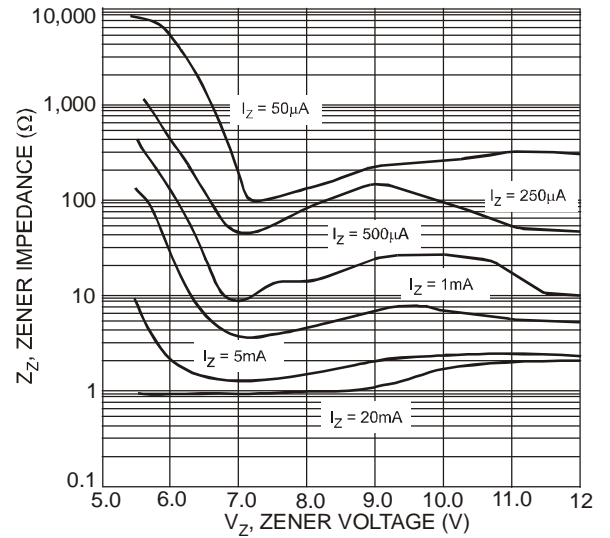

Fig. 11 Typical Zener Impedance Characteristics, DDZ5V6BS - DDZ12CS

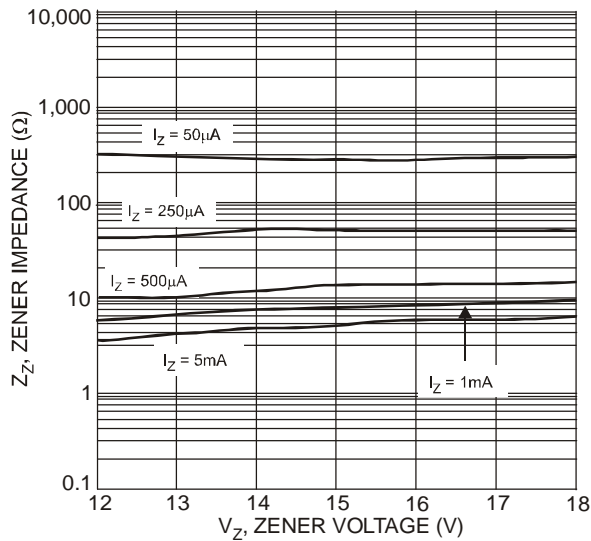

Fig. 12 Typical Zener Impedance Characteristics, DDZ12CS - DDZ18CS

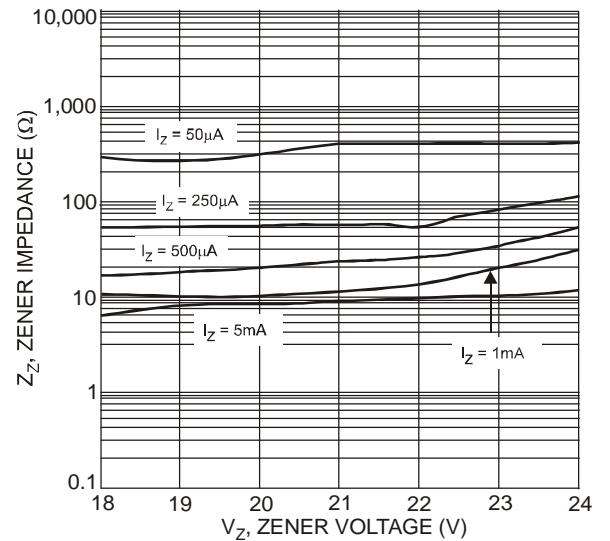

Fig. 13 Typical Zener Impedance Characteristics, DDZ18CS - DDZ24CS

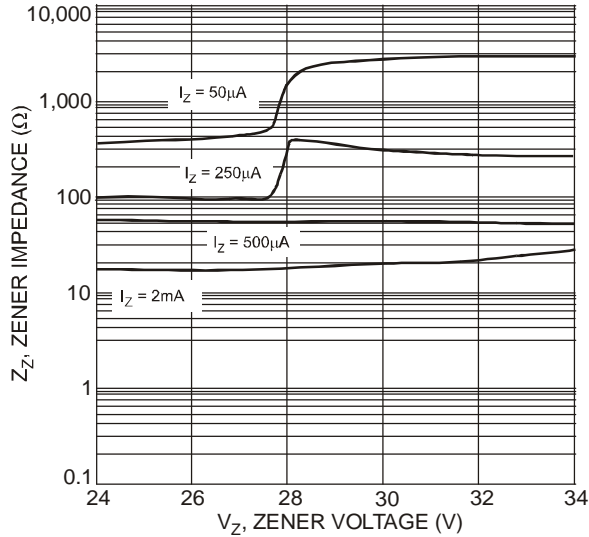

Fig. 14 Typical Zener Impedance Characteristics, DDZ24CS - DDZ33S

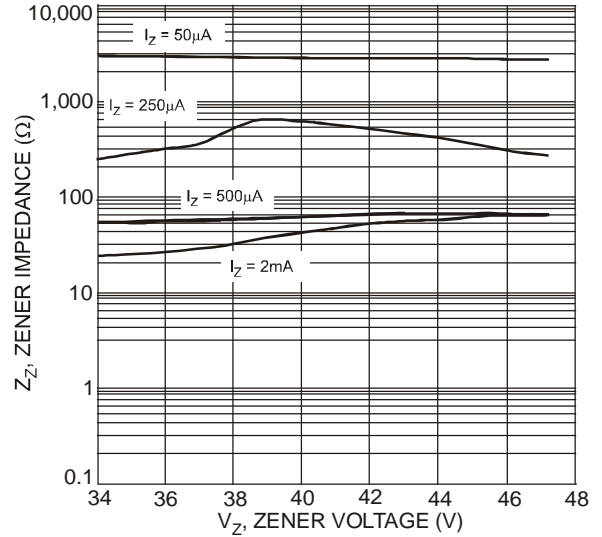

Fig. 15 Typical Zener Impedance Characteristics, DDZ36S - DDZ43S

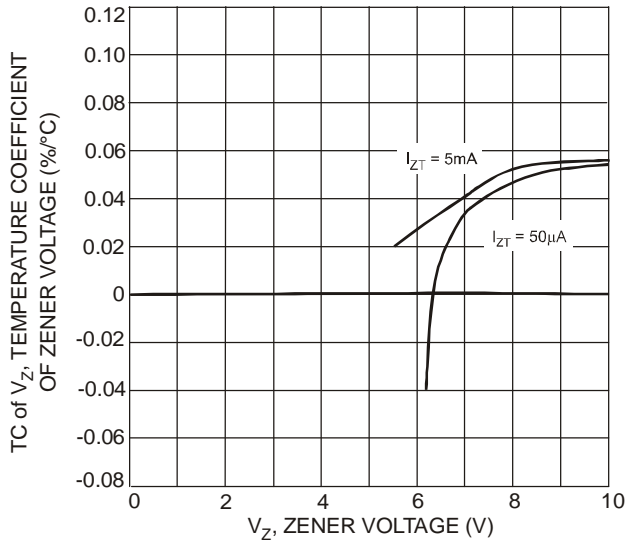

Fig. 16 Typical Temperature Coefficient of Zener Voltage vs. Zener Voltage, DDZ6V2BS-DDZ10CS

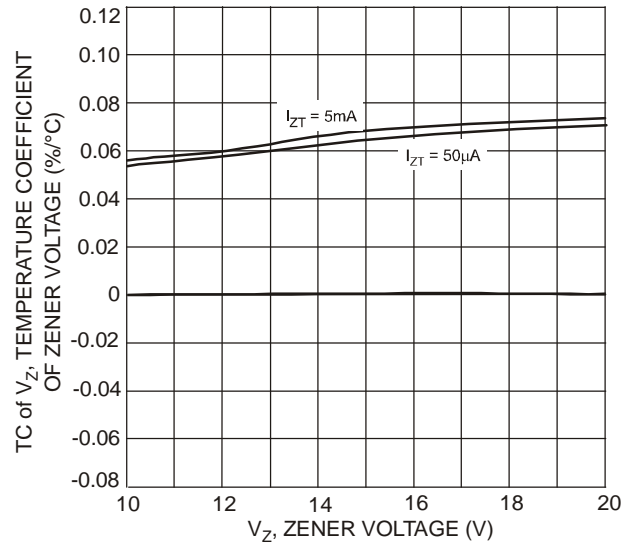

Fig. 17 Typical Temperature Coefficient of Zener Voltage vs. Zener Voltage, DDZ10CS-DDZ20CS

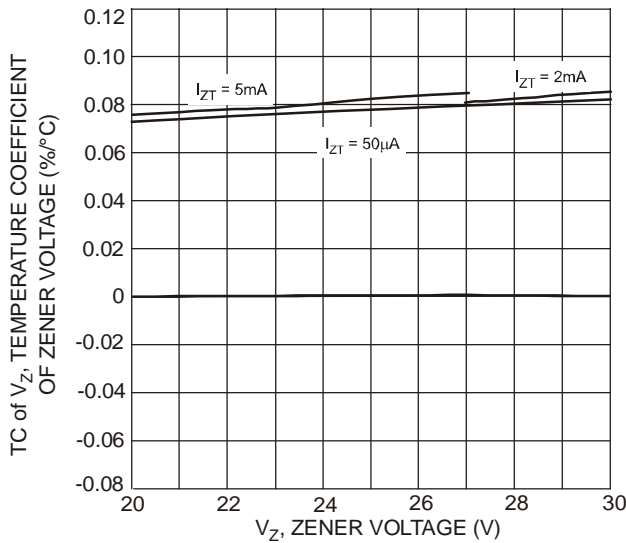

Fig. 18 Typical Temperature Coefficient of Zener Voltage vs. Zener Voltage, DDZ20CS-DDZ30DS

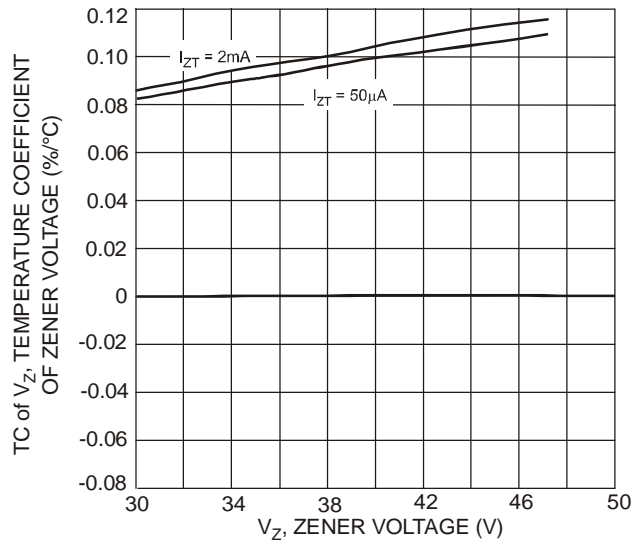

Fig. 19 Typical Temperature Coefficient of Zener Voltage vs. Zener Voltage, DDZ30DS-DDZ43S

Ordering Information (Note 8)

Part Number (Type Number)-7*	Case SOD-323	Packaging 3000/Tape & Reel
---------------------------------	-----------------	-------------------------------

* Example: The part number for the 6.2 Volt device would be DDZ6V2BS-7.

Notes: 8. For packaging details, go to our website at <http://www.diodes.com/datasheets/ap02007.pdf>.

Marking Information



xx = Product Type Marking Code
(See Electrical Characteristics Table)

Package Outline Dimensions

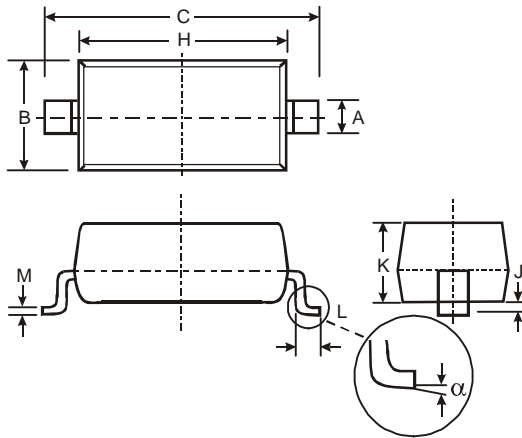

SOD-323		
Dim	Min	Max
A	0.25	0.35
B	1.20	1.40
C	2.30	2.70
H	1.60	1.80
J	0.00	0.10
K	1.0	1.1
L	0.20	0.40
M	0.10	0.15
α	0°	8°
All Dimensions in mm		

Suggested Pad Layout

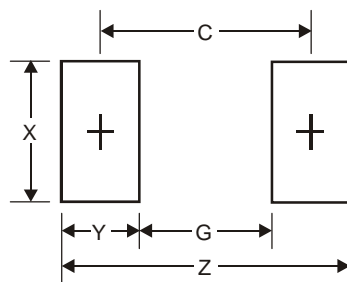

Dimensions	Value (in mm)
Z	3.75
G	1.05
X	0.65
Y	1.35
C	2.40

IMPORTANT NOTICE

Diodes Incorporated and its subsidiaries reserve the right to make modifications, enhancements, improvements, corrections or other changes without further notice to any product herein. Diodes Incorporated does not assume any liability arising out of the application or use of any product described herein; neither does it convey any license under its patent rights, nor the rights of others. The user of products in such applications shall assume all risks of such use and will agree to hold Diodes Incorporated and all the companies whose products are represented on our website, harmless against all damages.

LIFE SUPPORT

Diodes Incorporated products are not authorized for use as critical components in life support devices or systems without the expressed written approval of the President of Diodes Incorporated.