

MM3Z2V4C-MM3Z75VC

Zener Diodes

Features

- Wide Zener Voltage Range Selection, 2.4V to 75V
- VZ Tolerance Selection of ±5% (C Series)
- Very Small and Thin SMD package
- Matte Tin(Sn) finish, Pb Free

Connection Diagram

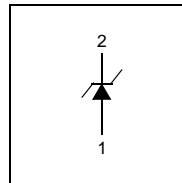
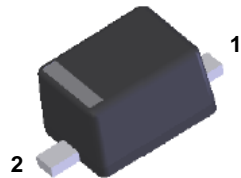

* Band Denotes Cathode **SOD-323F**

Absolute Maximum Ratings $T_A = 25^\circ\text{C}$ unless otherwise noted

Symbol	Parameter	Value	Units
P_D	Power Dissipation	200	mW
T_{STG}	Storage Temperature Range	-65 to +150	$^\circ\text{C}$
T_J	Maximum Junction Temperature	150	$^\circ\text{C}$
I_{ZM}	Maximum Regulator Current	P_D/V_Z	mA

* These ratings are limiting values above which the serviceability of the diode may be impaired.

Thermal Characteristics

Symbol	Parameter	Value	Unit
$R_{\theta JA}$	Thermal Resistance, Junction to Ambient	595	$^\circ\text{C}/\text{W}$

* Device mounted on PCB with minimum land pad.

Electrical Characteristics $T_A = 25^\circ\text{C}$ unless otherwise specified

Symbol	Parameter/ Test condition	Min.	Typ.	Max.	Unit
V_F	Forward Voltage / $I_F=10\text{ mA}$	--	--	1.0	V

Package Marking and Ordering Information

Device Marking	Device	Package	Packing	Reel Size	Tape Width	Quantity
Refer to Product table list	Refer to Product table list	SOD-323F	Tape & Reel	7"	12mm	3,000

Electrical Characteristics $T_A=25^\circ\text{C}$ unless otherwise noted

Device Type	Device Marking	V_Z (V) @ I_{ZT}			$Z_{ZT}(\Omega)$ @ I_{ZT}	I_{ZT} (mA)	$Z_{ZK}(\Omega)$ @ I_{ZK}	I_{ZK} (mA)	$I_R(\mu\text{A})$ @ V_R	V_R (V)
		Min.	Typ.	Max.	Max.	-	Max.	-	Max	-
MM3Z2V4C	Z0	2.28	2.4	2.52	94	5	564	1	45	1
MM3Z2V7C	Z1	2.57	2.7	2.84	94	5	564	1	18	1
MM3Z3V0C	Z2	2.85	3	3.15	89	5	564	1	9	1
MM3Z3V3C	Z3	3.14	3.3	3.47	89	5	564	1	4.5	1
MM3Z3V6C	Z4	3.42	3.6	3.78	84	5	564	1	4.5	1
MM3Z3V9C	Z5	3.71	3.9	4.1	84	5	564	1	2.7	1
MM3Z4V3C	Z6	4.09	4.3	4.52	84	5	564	1	2.7	1
MM3Z4V7C	Z7	4.47	4.7	4.94	75	5	470	1	2.7	2
MM3Z5V1C	Z8	4.85	5.1	5.36	56	5	451	1	1.8	2
MM3Z5V6C	Z9	5.32	5.6	5.88	37	5	376	1	0.9	2
MM3Z6V2C	ZA	5.89	6.2	6.51	9	5	141	1	2.7	4
MM3Z6V8C	ZB	6.46	6.8	7.14	14	5	75	1	1.8	4
MM3Z7V5C	ZC	7.11	7.5	7.86	14	5	75	1	0.9	5
MM3Z8V2C	ZD	7.79	8.2	8.61	14	5	75	1	0.63	5
MM3Z9V1C	ZE	8.65	9.1	9.56	14	5	94	1	0.45	6
MM3Z10VC	ZF	9.5	10	10.5	18	5	141	1	0.18	7
MM3Z11VC	ZG	10.45	11	11.55	18	5	141	1	0.09	8
MM3Z12VC	ZH	11.4	12	12.6	23	5	141	1	0.09	8
MM3Z13VC	ZJ	12.35	13	13.65	28	5	160	1	0.09	8
MM3Z15VC	ZK	14.25	15	15.75	28	5	188	1	0.045	10.5
MM3Z16VC	ZL	15.2	16	16.8	37	5	188	1	0.045	11.2
MM3Z18VC	ZM	17.1	18	18.9	42	5	212	1	0.045	12.6
MM3Z20VC	ZN	19	20	21	51	5	212	1	0.045	14
MM3Z22VC	ZP	20.9	22	23.1	51	5	235	1	0.045	15.4
MM3Z24VC	ZR	22.8	24	25.2	65	5	235	1	0.045	16.8
MM3Z27VC	ZS	25.65	27	28.35	75	2	282	0.5	0.045	18.9
MM3Z30VC	ZT	28.5	30	31.5	75	2	282	0.5	0.045	21
MM3Z33VC	ZU	31.35	33	34.65	75	2	306	0.5	0.045	23
MM3Z36VC	ZV	34.2	36	37.8	84	2	329	0.5	0.045	25.2
MM3Z39VC	ZW	37.05	39	40.95	122	2	329	0.5	0.045	27.3
MM3Z43VC	ZX	40.85	43	45.15	141	2	353	0.5	0.045	30.1
MM3Z47VC	ZY	44.65	47	49.35	160	2	353	0.5	0.045	33
MM3Z51VC	Z _⏟	48.45	51	53.55	169	2	376	0.5	0.045	35.7
MM3Z56VC	Z _{⏟⏟}	53.2	56	58.8	188	2	400	0.5	0.045	39.2
MM3Z62VC	Z _{⏟⏟⏟}	58.9	62	65.1	202	2	423	0.5	0.045	43.4
MM3Z68VC	Z _{>}	64.6	68	71.4	226	2	447	0.5	0.045	47.6
MM3Z75VC	Z _{<}	71.25	75	78.75	240	2	470	0.5	0.045	52.5

Notes :

1. The Zener Voltage (V_Z) is tested under pulse condition of 10mS.
2. The device numbers listed have a standard tolerance on the nominal zener voltage of $\pm 5\%$.
3. The zener impedance is derived from the 60-cycle ac voltage, which results when an ac current having an rms value equal to 10% of the dc zener current (I_{ZT} or I_{ZK}) is superimposed to I_{ZT} or I_{ZK} .

Typical Performance Characteristics

Figure 1. Zener current vs. Zener Voltage

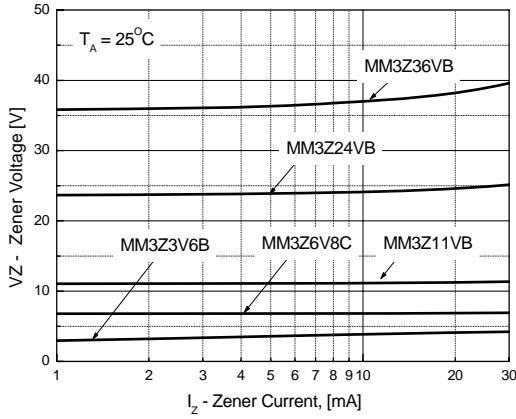

Figure 2. Zener current vs. Zener Impedance

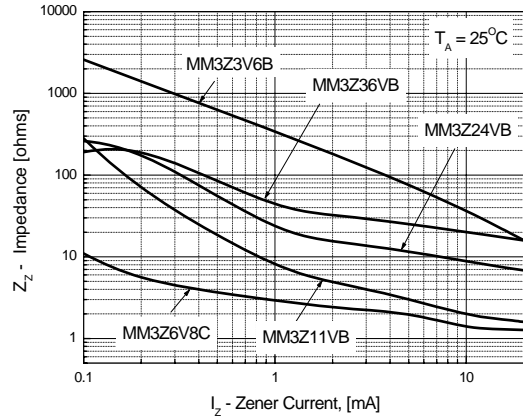

Figure 3. MM3Z3V6B
Zener current vs. Zener Voltage

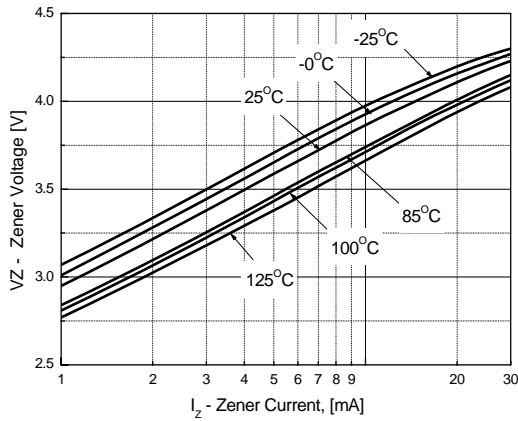

Figure 4. MM3Z6V8C
Zener current vs. Zener Voltage

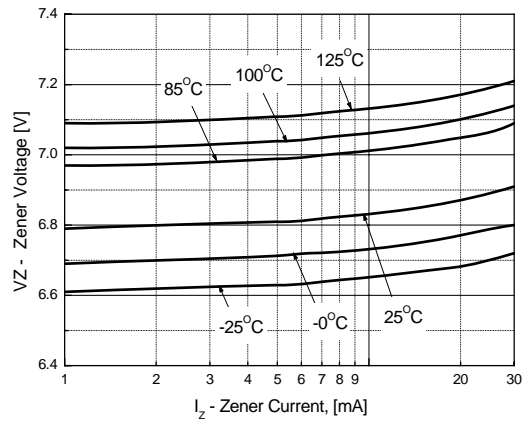

Figure 5. MM3Z11VB
Zener current vs. Zener Voltage

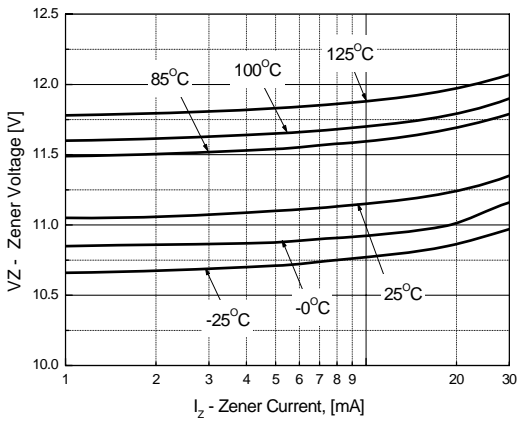
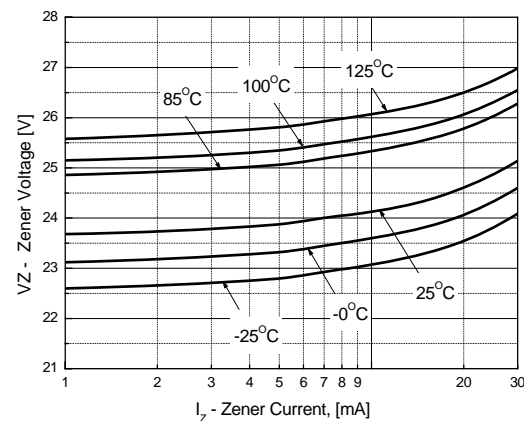
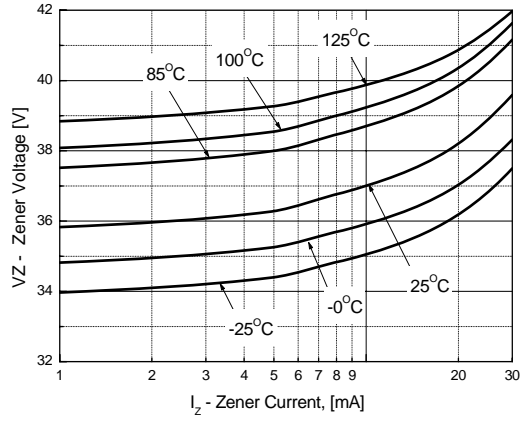

Figure 6. MM3Z24VB
Zener current vs. Zener Voltage



Typical Performance Characteristics (Continued)

Figure 7. MM3Z36VB
Zener current vs. Zener Voltage



Package Dimensions

SOD - 323F

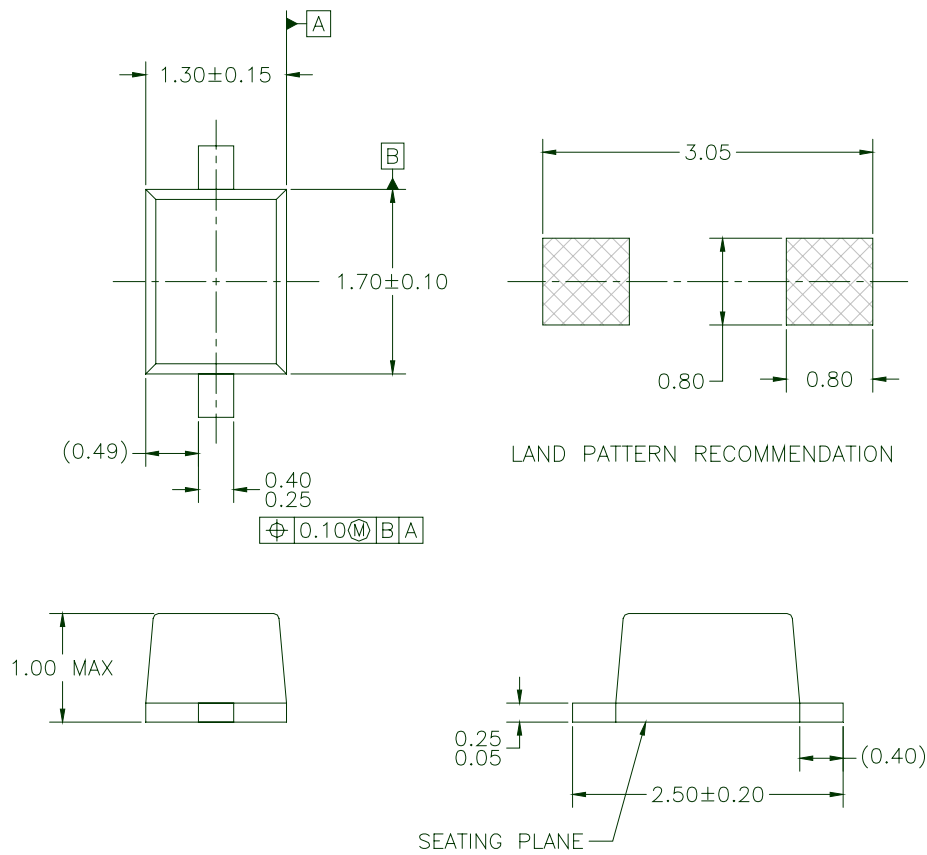





NOTES: UNLESS OTHERWISE SPECIFIED

- A) THIS PACKAGE IS COMPLIANT TO JEITA SC90 STANDARD EXCEPT FOR THE OVERALL PACKAGE HEIGHT.
- B) ALL DIMENSIONS ARE IN MILLIMETERS.
- C) DIMENSIONS ARE EXCLUSIVE OF BURRS, MOLD FLASH AND TIE BAR EXTRUSIONS.
- D) DIMENSIONING AND TOLERANCING PER ASME Y14.5M - 1994.



TRADEMARKS

The following includes registered and unregistered trademarks and service marks, owned by Fairchild Semiconductor and/or its global subsidiaries, and is not intended to be an exhaustive list of all such trademarks.

- | | | | |
|--|---|--|---|
| Auto-SPM™ | F-PFS™ | PowerTrench® | The Power Franchise® |
| Build it Now™ | FRFET® | PowerXS™ | the power franchise™ |
| CorePLUS™ | Global Power Resource™ | Programmable Active Droop™ | TinyBoost™ |
| CorePOWER™ | Green FPS™ | QFET® | TinyBuck™ |
| CROSSVOLT™ | Green FPS™ e-Series™ | QS™ | TinyLogic® |
| CTL™ | Gmax™ | Quiet Series™ | TINYOPTO™ |
| Current Transfer Logic™ | GTO™ | RapidConfigure™ | TinyPower™ |
| EcoSPARK® | IntelliMAX™ |  ™ | TinyPWM™ |
| EfficientMax™ | ISOPLANAR™ | Saving our world, 1mW/W/kW at a time™ | TinyWire™ |
| EZSWITCH™* | MegaBuck™ | SmartMax™ | TriFault Detect™ |
|  ™* | MICROCOUPLER™ | SMART START™ | TRUECURRENT™* |
| F® | MicroFET™ | SPM® | µSerDes™ |
| Fairchild® | MicroPak™ | STEALTH™ |  ™ |
| Fairchild Semiconductor® | MillerDrive™ | SuperFET™ | UHC® |
| FACT Quiet Series™ | MotionMax™ | SuperSOT™-3 | Ultra FRFET™ |
| FACT® | Motion-SPM™ | SuperSOT™-6 | UniFET™ |
| FAST® | OPTOLOGIC® | SuperSOT™-8 | VCX™ |
| FastvCore™ | OPTOPLANAR® | SupreMOS™ | VisualMax™ |
| FETBench™ |  ™ | SyncFET™ | XST™ |
| FlashWriter®* | PDP SPM™ | Sync-Lock™ | |
| FPS™ | Power-SPM™ |  ™* | |

* Trademarks of System General Corporation, used under license by Fairchild Semiconductor.

DISCLAIMER

FAIRCHILD SEMICONDUCTOR RESERVES THE RIGHT TO MAKE CHANGES WITHOUT FURTHER NOTICE TO ANY PRODUCTS HEREIN TO IMPROVE RELIABILITY, FUNCTION, OR DESIGN. FAIRCHILD DOES NOT ASSUME ANY LIABILITY ARISING OUT OF THE APPLICATION OR USE OF ANY PRODUCT OR CIRCUIT DESCRIBED HEREIN; NEITHER DOES IT CONVEY ANY LICENSE UNDER ITS PATENT RIGHTS, NOR THE RIGHTS OF OTHERS. THESE SPECIFICATIONS DO NOT EXPAND THE TERMS OF FAIRCHILD'S WORLDWIDE TERMS AND CONDITIONS, SPECIFICALLY THE WARRANTY THEREIN, WHICH COVERS THESE PRODUCTS.

LIFE SUPPORT POLICY

FAIRCHILD'S PRODUCTS ARE NOT AUTHORIZED FOR USE AS CRITICAL COMPONENTS IN LIFE SUPPORT DEVICES OR SYSTEMS WITHOUT THE EXPRESS WRITTEN APPROVAL OF FAIRCHILD SEMICONDUCTOR CORPORATION.

As used herein:

- Life support devices or systems are devices or systems which, (a) are intended for surgical implant into the body or (b) support or sustain life, and (c) whose failure to perform when properly used in accordance with instructions for use provided in the labeling, can be reasonably expected to result in a significant injury of the user.
- A critical component in any component of a life support, device, or system whose failure to perform can be reasonably expected to cause the failure of the life support device or system, or to affect its safety or effectiveness.

ANTI-COUNTERFEITING POLICY

Fairchild Semiconductor Corporation's Anti-Counterfeiting Policy. Fairchild's Anti-Counterfeiting Policy is also stated on our external website, www.fairchildsemi.com, under Sales Support.

Counterfeiting of semiconductor parts is a growing problem in the industry. All manufacturers of semiconductor products are experiencing counterfeiting of their parts. Customers who inadvertently purchase counterfeit parts experience many problems such as loss of brand reputation, substandard performance, failed applications, and increased cost of production and manufacturing delays. Fairchild is taking strong measures to protect ourselves and our customers from the proliferation of counterfeit parts. Fairchild strongly encourages customers to purchase Fairchild parts either directly from Fairchild or from Authorized Fairchild Distributors who are listed by country on our web page cited above. Products customers buy either from Fairchild directly or from Authorized Fairchild Distributors are genuine parts, have full traceability, meet Fairchild's quality standards for handling and storage and provide access to Fairchild's full range of up-to-date technical and product information. Fairchild and our Authorized Distributors will stand behind all warranties and will appropriately address any warranty issues that may arise. Fairchild will not provide any warranty coverage or other assistance for parts bought from Unauthorized Sources. Fairchild is committed to combat this global problem and encourage our customers to do their part in stopping this practice by buying direct or from authorized distributors.

PRODUCT STATUS DEFINITIONS

Definition of Terms

Datasheet Identification	Product Status	Definition
Advance Information	Formative / In Design	Datasheet contains the design specifications for product development. Specifications may change in any manner without notice.
Preliminary	First Production	Datasheet contains preliminary data; supplementary data will be published at a later date. Fairchild Semiconductor reserves the right to make changes at any time without notice to improve design.
No Identification Needed	Full Production	Datasheet contains final specifications. Fairchild Semiconductor reserves the right to make changes at any time without notice to improve the design.
Obsolete	Not In Production	Datasheet contains specifications on a product that is discontinued by Fairchild Semiconductor. The datasheet is for reference information only.