

Single Phase Rectifier Bridge

Standard and Avalanche Types

$$I_{dAV} = 31 \text{ A}$$

$$V_{RRM} = 800-1600 \text{ V}$$

V_{RSM} V	V_{BRmin} ① V	V_{RRM} V	Standard Types	Avalanche Types
900		800	VBO 25-08NO2	
1300	1230	1200	VBO 25-12NO2	VBO 25-12AO2
1700	1630	1600	VBO 25-16NO2	VBO 25-16AO2

① For Avalanche Type only

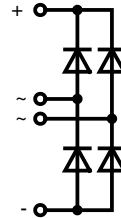

Symbol	Conditions	Maximum Ratings	
I_{dAV} ②	$T_C = 85^\circ\text{C}$, module	38	A
I_{dAVM}	module	40	A
P_{RSM}	$T_{VJ} = T_{VJM}$	3.4	kW
I_{FSM}	$T_{VJ} = 45^\circ\text{C}$; $t = 10 \text{ ms}$ (50 Hz)	370	A
	$V_R = 0$; $t = 8.3 \text{ ms}$ (60 Hz)	390	A
	$T_{VJ} = T_{VJM}$; $t = 10 \text{ ms}$ (50 Hz)	320	A
	$V_R = 0$; $t = 8.3 \text{ ms}$ (60 Hz)	340	A
I^2t	$T_{VJ} = 45^\circ\text{C}$; $t = 10 \text{ ms}$ (50 Hz)	680	A ² s
	$V_R = 0$; $t = 8.3 \text{ ms}$ (60 Hz)	640	A ² s
	$T_{VJ} = T_{VJM}$; $t = 10 \text{ ms}$ (50 Hz)	510	A ² s
	$V_R = 0$; $t = 8.3 \text{ ms}$ (60 Hz)	470	A ² s
T_{VJ}		-40...+150	°C
T_{VJM}		150	°C
T_{stg}		-40...+125	°C
V_{ISOL}	50/60 Hz, RMS $t = 1 \text{ min}$	3000	V~
	$I_{ISOL} \leq 1 \text{ mA}$ $t = 1 \text{ s}$	3600	V~
M_d	Mounting torque (M5) (10-32 UNF)	1.5-2	Nm
		13-18	lb.in.
Weight	Typ.	15	g

Symbol	Conditions	Characteristic Values	
I_R	$V_R = V_{RRM}$ $T_{VJ} = 25^\circ\text{C}$ $T_{VJ} = T_{VJM}$	0.3	mA
		5.0	mA
V_F	$I_F = 55 \text{ A}$ $T_{VJ} = 25^\circ\text{C}$	1.36	V
V_{T0}	For power-loss calculations only	0.85	V
r_t		8	mΩ
R_{thJC}	per diode; 120° el. per module	2.80	K/W
		0.70	K/W
R_{thJH}	per diode; 120° el. per module	3.20	K/W
		0.80	K/W
d_S	Creeping distance on surface	13	mm
d_A	Creepage distance in air ③	9.5	mm
a	Max. allowable acceleration	50	m/s ²

Data according to IEC 60747 and refer to a single diode unless otherwise stated.

② for resistive load at bridge output

③ with isolated fast-on tabs.

IXYS reserves the right to change limits, test conditions and dimensions.

© IXYS All rights reserved

Features

- Avalanche rated parts available
- Package with DCB ceramic base plate
- Isolation voltage 3600 V~
- Planar passivated chips
- Low forward voltage drop
- ¼" fast-on terminals
- UL registered E 72873

Applications

- Supplies for DC power equipment
- Input rectifiers for PWM inverter
- Battery DC power supplies
- Field supply for DC motors

Advantages

- Easy to mount with one screw
- Space and weight savings
- Improved temperature & power cycling

Dimensions in mm (1 mm = 0.0394")

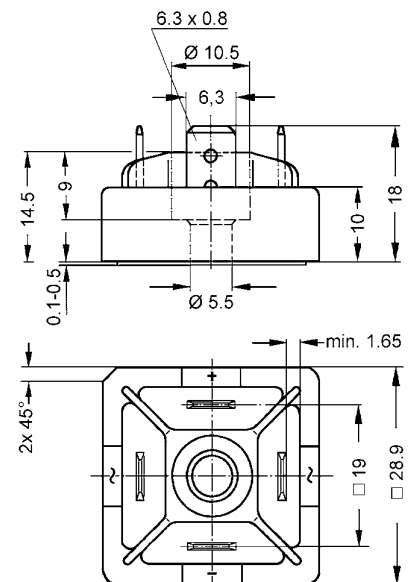

20100706b

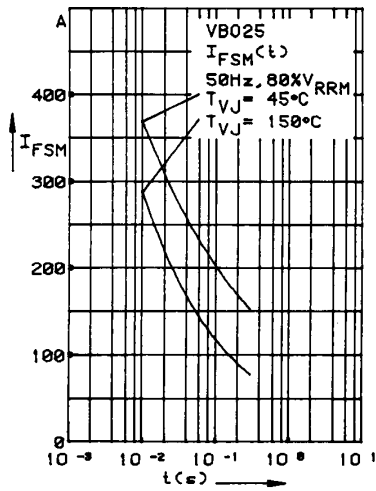

Fig. 1 Surge overload current per diode
 I_{FSM} : Crest value, t : duration

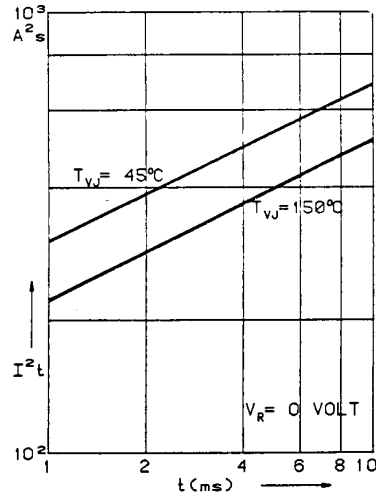

Fig. 2 I^2t versus time (1-10 ms) per diode

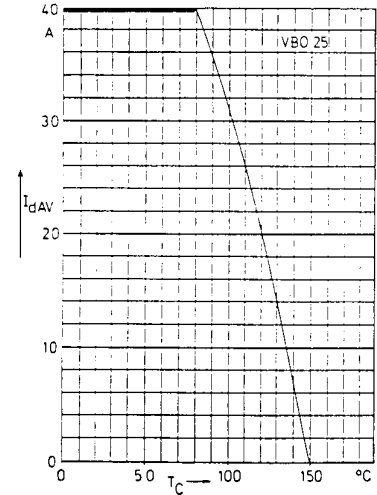

Fig. 3 Max. forward current at case temperature

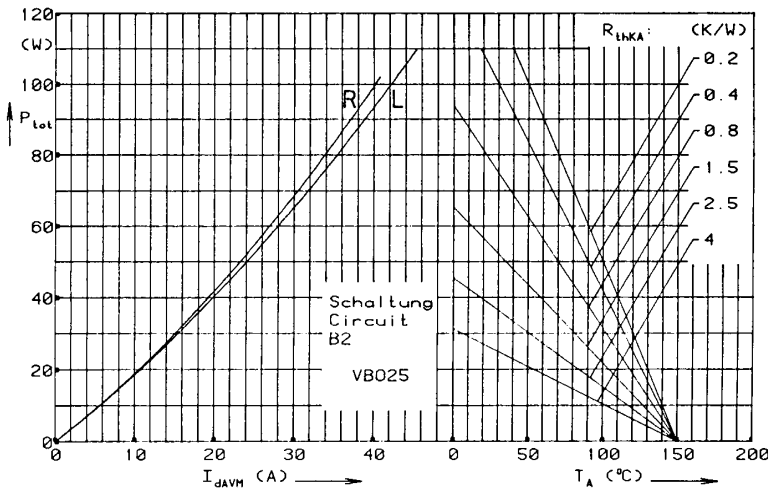

Fig. 4 Power dissipation versus direct output current and ambient temperature

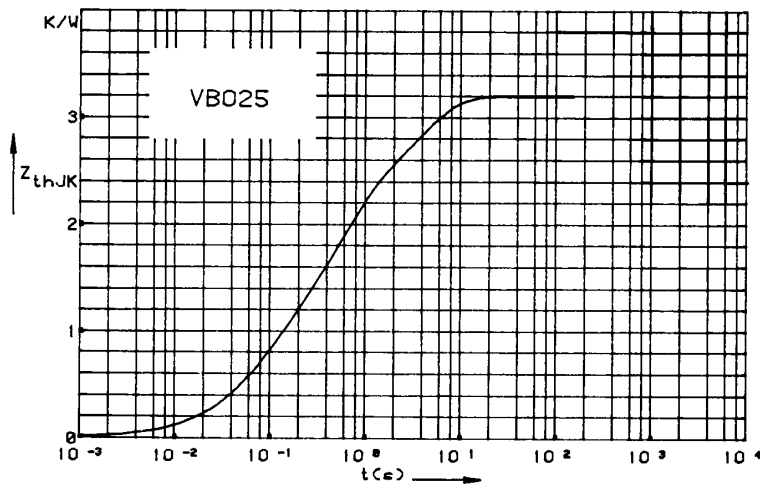

Fig. 5 Transient thermal impedance junction to heatsink per diode

Constants for Z_{thJK} calculation:

i	R_{thi} (K/W)	t_i (s)
1	0.775	0.0788
2	1.390	0.504
3	1.055	3.701

IXYS reserves the right to change limits, test conditions and dimensions.

20100706b