

**SOURCE CONTROL DRAWING**  
**OFFICIAL SPECIFICATION**

Item :	<b>5.0X3.2X1.1mm CERAMIC MINIATURE CERAMIC SMD CRYSTAL</b>
EMBER CORP P/N	565-2400-000
ABRACON P/N :	ABM3B-24.000MHZ-R60-D1W-T

<p><b>Customer's Approval</b> Please return this copy as a certification of your approval.</p> <p>Approved by: _____</p> <p>Date : _____</p>
--

**PROPRIETARY NOTICE**  
These documents, and the contained information herein, are proprietary and are not to be reproduced, used or disclosed to others for manufacture or for any other purpose, except as specifically authorized, in writing, by Abracon Corporation.

**ABRACON CORPORATION**

Headquarters  
30332 Esperanza, Rancho Santa Margarita  
California, The USA.  
Tel : 949-546-8000  
Fax: 949-546-8001

Internal Use Only	
500050	500250
500620	500155
500015	500710

**WARNING: ESD SENSITIVE PRODUCT**

REVISION HISTORY				
REV.	ECO	DESCRIPTION	DATE	APP'D
-	-	New release	1/22/2007	HU
A	2015	Revise the format, and T&C of sale. Corrected the part number.	3/9/2009	HU



TITLE  
**ABM3B-24.000MHZ-R60-D1W-T**  
**5.0X3.2X1.1mm CERAMIC MINIATURE CERAMIC SMD CRYSTAL**

PREP. HU	DATE 3/9/2009	ENGR. HU	DATE 3/9/2009	SCALE None	DRAWING NO. <b>452491</b>	REV. <b>A</b>
CKD CB	DATE 3/9/2009	APP'D JE	DATE 3/10/2009	PAGE OF 1 OF 9		

**1.0 SCOPE**

This specification describes a 5.0x3.2x1.1mm MINIATURE CERAMIC SMD CRYSTAL.

**2.0 ELECTRICAL SPECIFICATIONS**

Abracon P/N:	<b>ABM3B-24.000MHZ-R60-D1W-T</b>
Frequency range:	<b>24.000MHz</b>
Operation mode:	<b>Fundamental, AT-strip</b>
Operating temperature:	<b>- 40°C to + 85°C</b>
Storage temperature:	<b>- 55°C to + 125° C</b>
Frequency Tolerance at +25° C:	<b>± 10 ppm max.</b>
Frequency stability over the operating temperature (Ref to +25° C):	<b>± 25 ppm max.</b>
Equivalent series resistance:	<b>60ohms max.</b>
Shunt capacitance C0:	<b>7.0pF max</b>
Load capacitance CL:	<b>18.0+/-1.0pF</b>
Drive level:	<b>100uW max, 10uW Typical</b>
Aging (first year) 25°C ± 3°C:	<b>±5ppm max</b>
Insulation Resistance:	<b>500Mohms min at 100Vdc ± 15V</b>

**3.0 SPECIAL REQUIREMENT**

This product is RoHS compliant and Pb free.

**4.0 Marking**

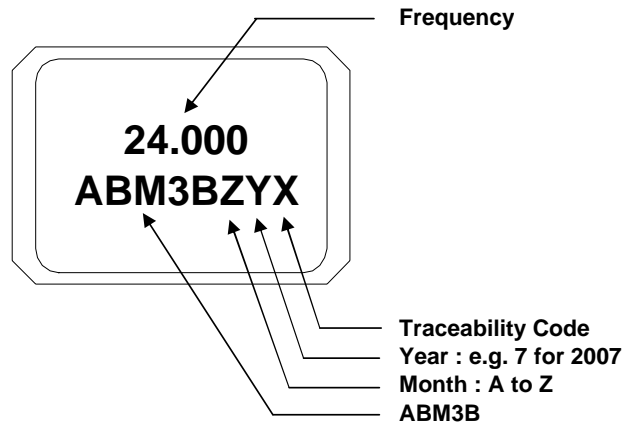

Month	Code
January	A
February	B
March	C
April	D
May	E
June	F
July	G
August	H
September	I
October	J
November	K
December	L

**4.1 Marking Method : Laser Marking**

5.0 Outline dimensions

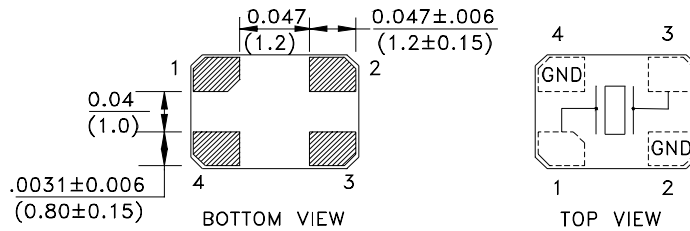
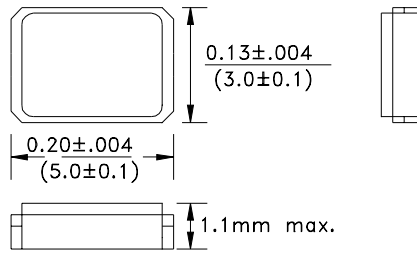

**Chamfer on PIN 1  
(Default)**

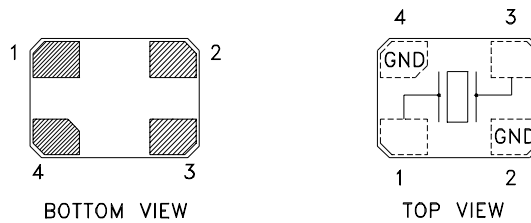

**Chamfer on PIN 4  
(See Note)**

**Note:** Due to the availability of raw materials, this part may be manufactured with the chamfer on pin 4. Be advised that this does not affect the electrical characteristics of the crystal in any way.

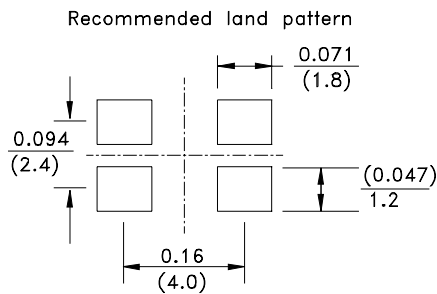

Dimension : Inches (mm)

TOLERANCES:

UNLESS OTHERWISE SPECIFIED: .X: ± 0.1 (0.25) .XX: ± 0.01 (0.025) .XXX: ± 0.005 (0.013)

### 6.0 Reliability Test

No.	Test Items	Test Conditions
1	Temperature Cycling:	The component shall remain within the electrical specification ( $\pm 5$ ppm max) after 3 cycles of high and low temperature testing (-40°C to +85°C) for 2 hours max.
2	Thermal Shock:	The component shall remain within the electrical specification after exposure at extreme temperature -40°C to +85°C for 5 minutes for 3 cycles.
3	Vibration:	The component shall remain within the electrical specification after loaded vibration at 10Hz to 55Hz, amplitude 1.5mm, within 1 minute for 2 hours minimum on each axis (X,Y,Z).
4	Drop Test:	The component shall remain within the electrical specifications after a natural drop (3X) on a hard wooden board at 75 cm.
5	Humidity:	The component shall remain within the electrical specifications after being kept at a condition of ambient temperature +85°C, 85% RH for 96 hours minimum.
6	Fine Leak Test:	Expose samples to 60PSIG Helium gas for 2 hours. Max leak rate $2 \times 10^{-8}$ atmcc/s.
7	Gross Leak Test:	Submerge samples in 100% De-ionized water or Perfluorocarbon at 85°C for at least 1 minute. Check for bubbles.
8	Solderability:	Solderability of terminals shall be kept at more than 95% after dipped in solder flux at $230^\circ\text{C} \pm 5^\circ\text{C}$ for 5 seconds.

### 6.1 Reflow Profile

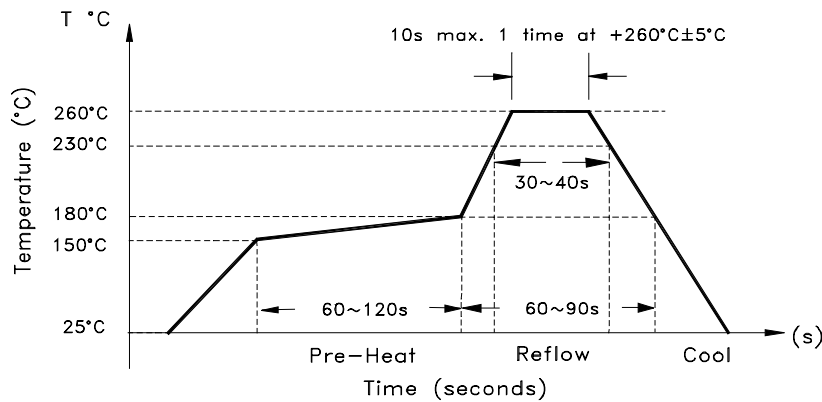

**7.0 PACKING**

Tape and reel (1,000pcs/reel)

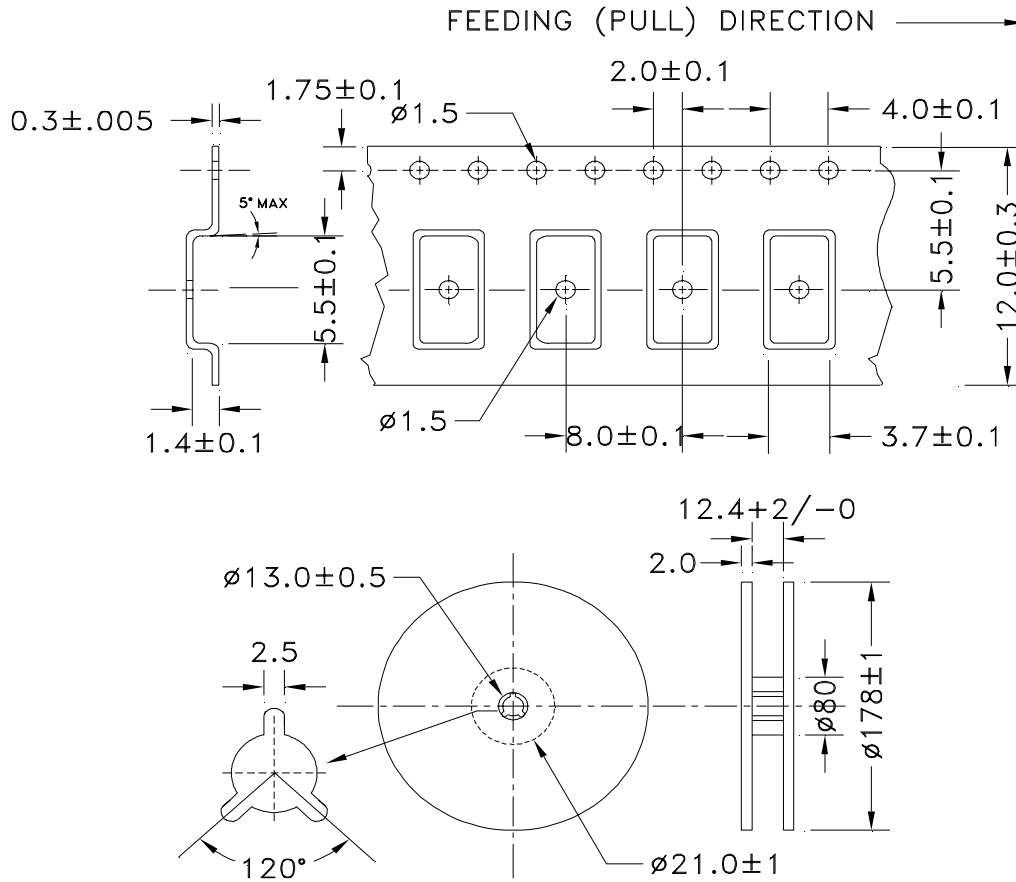

Dimension : Inches (mm)

TOLERANCES:

UNLESS OTHERWISE SPECIFIED: .X: ± 0.1 (0.25) .XX: ± 0.01 (0.025) .XXX: ± 0.005 (0.013)

**8.0 NOTE**

- (1) The parts are manufactured in accordance with this specification. If other conditions and specifications which are required for this specification, please contact ABRACON for more information.
- (2) ABRACON will supply the parts in accordance with this specification unless we receive a written request to modify prior to an order placement.
- (3) In no case shall ABRACON be liable for any product failure from in appropriate handling or operation of the item beyond the scope of this specification.
- (4) When changing your production process, please notify ABRACON immediately.
- (5) If you intend to use the product for listed application which may possibly cause to loss of life or assets, please notify ABRACON in advance.  
(For example, Medical, Aerospace, Aeronautic equipment, Safety control equipment as well as safety related.)
- (6) All specifications and Marking will be subject to change without notice.

### 9.0 TERMS AND CONDITIONS OF SALE

PLEASE NOTE: Claims for pricing errors, shortages and defective products must be reported within 10 days from receipt of goods. Returned products will not be accepted after 30 days from the invoice date, and may be subject to restocking fees in accordance with Abracon Corporation's return policy. Abracon standard product purchase orders may not be canceled within 60 days of original shipping date. Abracon non-standard product purchase orders are non-cancelable and non-returnable. All schedule changes must be requested prior to 30 days of original shipping date. Maximum schedule change "push-out" shall be no more than 30 days from original shipping date. Abracon reserves the right to review all schedule and quantity changes and make pricing changes as needed.

NO CREDIT WILL BE GIVEN FOR PRODUCTS RETURNED WITHOUT PRIOR AUTHORIZATION.

Please also note that IN NO EVENT SHALL ABRACON'S TOTAL LIABILITY FOR ANY AND ALL LOSSES AND DAMAGES ARISING OUT OF ANY CAUSE (INCLUDING, BUT NOT LIMITED TO, CONTRACT, NEGLIGENCE, STRICT LIABILITY OR OTHER TORT) EXCEED THE PURCHASE COST OF THE PRODUCTS. IN NO EVENT SHALL ABRACON BE LIABLE FOR ANY INCIDENTAL, CONSEQUENTIAL OR PUNITIVE DAMAGES.

Placing an order with ABRACON constitutes an acknowledgement that you have read and agree to the "Terms and Conditions of Sale."

1. Prices: ABRACON (AB) reserves the right to increase the price of products by written notice to the Buyer at least thirty days prior to the date of shipment of the products. When quantity price discounts are quoted by AB, the discounts are computed separately for each type of product to be sold and are based upon the quantity of each type and each size ordered at any one time. If any order is reduced or cancelled by the Buyer with AB's consent, the prices shall be adjusted to the higher prices, if applicable, for the uncancelled quantity. Unless otherwise agreed, AB reserves the right to ship and bill ten percent more or less than the exact quantity specified.

2. Taxes: Unless otherwise specified in the quotation, the prices shown do not include any taxes, import, or export duties, tariffs, or customs charges. The Buyer agrees to pay AB the amount of any federal, state, county, municipal, or other taxes, duties, tariffs, or custom charges levied by any jurisdiction, foreign or domestic, which AB is required to pay on account of the ownership at the place of installation or during transit of the material or equipment which is the subject of this contract, or an account of the transportation, sale, or use of the material or equipment.

3. Payment Terms: Unless otherwise stated in a separate agreement or in AB's quotation, payment terms are thirty days net from the date of invoice, subject to approval from AB of amount and terms of credit. AB reserves the right to require payment in advance or C.O.D. and otherwise modified credit terms. When partial shipments are made, payments therefore shall become due in accordance with the above terms upon submission of invoices. If, at the request of the Buyer, shipment is postponed for more than thirty days, payment will become due thirty days after notice to the Buyer that products are ready for shipment. These terms apply to partial as well as complete shipments on the debt at the lesser of 18% per year, or the maximum then permitted by California law, from the due date until the Buyer pays the debt in full.

4. Shipment: All shipments will be made F.O.B. AB's shipping point. In the absence of specific instructions, AB will select the carrier. Title to the material shall pass to the Buyer upon delivery thereof by AB to the carrier or delivery service. Thereupon the Buyer shall be responsible therefore. Products held for the Buyer, or stored for the Buyer, shall be at the risk and expense of the Buyer. Claims against AB for shortages must be made in writing within ten days after the arrival of the shipment. AB is not required to notify the Buyer of the shipment.

5. Delivery: Shipping dates are approximate.

6. Packing: Unless otherwise specified, prices quoted herein include normal AB packaging. If special packaging is required by the Buyer, an additional charge will be made.

7. Inspection: Unless the Buyer notifies AB in writing within ten days from the date of receipt of any products that says the products are rejected, they will be deemed to have been accepted by the Buyer. In order for the notice of rejection to be effective, it must also specify the reasons why the products are being rejected. Any rejected products must be returned to AB within thirty days of rejection or the rejection shall be void and of no effect. Notwithstanding the preceding sentence, no returned goods will be accepted for credit unless written permission is first obtained from AB.

8. Limitation of Liability: AB shall not be liable for any loss, damage, cost of repairs, or incidental or consequential damages of any kind whether or not based upon express or implied warranty, negligence, or strict liability arising out of or in connection with the design, manufacture, sale, use, repair, or delivery of the product, or the engineering designs supplied to the Buyer. Without limiting the generality of the foregoing: if conditions arise which prevent compliance with delivery schedules, AB shall not be liable for any damage or penalty for delay in delivery, or for failure to give notice of delay, and such delay shall not constitute grounds for cancellation or price adjustment: in addition, AB shall not be liable for delay in delivery without regard to the cause of the delay, and delivery dates shall be deemed extended for a period equal to such delay.

9. Fair Labor Standards Act: AB certifies that products furnished hereunder have been or will be produced in compliance with the Fair Labor Standards Act, as amended and regulations and orders of the U.S. Department of Labor issued thereunder, AB agrees that this statement may be considered as the written assurance contemplated by the October 26, 1949 amendment to said Act.

10. Modifications: Unless otherwise provided, AB reserves the right to modify the specifications of products ordered by the Buyer providing that the modifications do not materially affect the performance.



11. Termination: In the event of the complete or partial termination or cancellation of this order for the convenience of the Government, settlement shall be made by negotiations in accordance with the Termination Clause for Subcontractors set forth in Armed Services Procurement Regulation 8-706. If the Buyer attempts to terminate or cancel this order, entirely or partially, other than for the convenience of the Government, it shall constitute a material breach of contract unless consent to said termination is obtained by the Buyer from AB in writing. In any event, the prices of all items delivered, and all items which have been furnished but not yet delivered, will be adjusted upward to the applicable price for the lesser quantities thereby purchased. AB may terminate or cancel this order in whole or in part at any time prior to the completion of performance by written notice to the Buyer without incurring any liability to the Buyer for breach of contract or otherwise.

12. Indemnity and Waiver of Subrogation: Buyer agrees to indemnify and hold AB harmless from any cost, liability or expense, including attorney's fees, which arises from or relates to any third party claim for personal injury (or death), property damages, or other loss allegedly based upon defective design, material, or workmanship of any product sold or furnished by AB, or allegedly based on any breach by AB of any of its contractual or other obligations. The Buyer represents that any liability insurance policies which the Buyer may have shall provide that subrogation rights against supplies such as AB are waived.

13. Governing Law: The terms of this agreement and all rights and obligations under it shall be governed by the laws of the State of California.

14. Errors: AB reserves the right to correct clerical or stenographic errors or omissions.

15. Entire Contract: The provisions of the Agreement and any accompanying documents constitute all the terms and conditions agreed upon by the parties and replace and supercede any inconsistent provisions on the face and the reverse side of the Purchase Order, Invoice, and Packing Slip. No modifications of this Agreement shall be valid unless in writing and duly signed by a person authorized by AB. The provisions of this Agreement shall not be modified by any usage of trade, or any course of prior dealing or acquiescence in the course of performance.

16. Disputes: Disputes between AB and the Buyer shall be resolved in accordance with the laws of the State of California without resort to said state's Conflict of Law rules. Pending final resolution of a dispute, AB shall proceed diligently with the performance of an order in accordance with AB's decision. In any legal action, arbitration, or other proceeding brought to enforce or interpret the terms of this agreement, the prevailing party shall be entitled to reasonably attorneys' fees and any other costs incurred in that proceeding in addition to any other relief to which it is entitled.