

# HC/49US (AT49) LOW PROFILE SURFACE MOUNT MICROPROCESSOR CRYSTAL

**ABLS2**

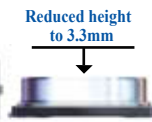

**RoHS**  
Compliant

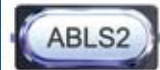

11.4 x 4.7 x 3.3 mm

## FEATURES:

- Suitable for RoHS compliant reflow
- Low height reduced to 3.3mm
- Available suitable for thin equipment
- Tight stability & extended temperature

## APPLICATIONS:

- Computers, Modems, Microprocessors
- Automotive and Industrial \*
- Wireless Applications

## STANDARD SPECIFICATIONS:

Parameters	Minimum	Typical	Maximum	Units	Notes
Frequency Range	3.579545	-----	24.00	MHz	Fundamental AT (Standard)
	24.01	-----	50.00		Fundamental AT or BT (See options)
	24.01	-----	70.00		3 <sup>rd</sup> Overtone (Standard)
Operation Mode	Fundamental or 3 <sup>rd</sup> Overtone				
Operating Temperature	0	-----	+70	°C	See options
Storage Temperature	-55	-----	+125	°C	
Frequency Tolerance @+25°C	-50	-----	+50	ppm	See options
Frequency Stability over the Operating Temperature ( ref. to +25°C)	-50	-----	+50	ppm	See options (For BT cut, ±100ppm max.at -10° C to +60° C only)
Equivalent series resistance (R1)	See table 1 below			Ω	
Shunt capacitance (C0)	-----	-----	7	pF	
Load capacitance (CL)	-----	18	-----	pF	Standard (See options if other than STD)
Drive Level	-----	100	1000	μW	
Aging	-5	-----	+5	ppm	@25°C±3°C First year
Insulation Resistance	500	-----	-----	MΩ	@ 100Vdc ± 15V
Drive level dependency (DLD)	Minimum 7 points tested: from 1μW to 500μW. Change in frequency (Maximum - Minimum) over DLD range < ±10ppm Change in ESR (Maximum - Minimum) over DLD range < 25% of Max ESR value. Maximum ESR over DLD range < Max ESR value.				

TABLE 1: ESR

FREQUENCY (MHz)	ESR (Ω)
3.579545 - 4.999 (Fund.)	180
5.000 - 5.999 (Fund.)	120
6.000 - 7.999 (Fund.)	100
8.000 - 8.999 (Fund.)	80
9.000 - 9.999 (Fund.)	60
10.000 - 15.999 (Fund.)	50
16.000 - 50.000 (Fund.)	40
24.01 - 31.999 (3rd O/T)	100
32.000 - 70.00 (3rd O/T)	80

# HC/49US (AT49) LOW PROFILE SURFACE MOUNT MICROPROCESSOR CRYSTAL

ABLS2



RoHS  
Compliant

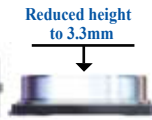

11.4 x 4.7 x 3.3 mm

## Options and Part Identification

(left blank if standard)

ABLS2 -  MHz -  -  -    -  -

### Frequency in MHz

Please specify the frequency in MHz. e.g. 14.31818MHz

### Load Capacitance (pF)

Please specify CL (Minimum 10pF) in pF or S for series

### Custom ESR if other than standard

R  
□: Specify a value in Ω (e.g.: R40)

### Operating Temp.

A: -10°C ~ +60°C
B: -20°C ~ +70°C
C: -30°C ~ +70°C
N: -30°C ~ +85°C
D: -40°C ~ +85°C
J*: -40°C ~ +105°C
K*: -40°C ~ +125°C
L*: -55°C ~ +125°C

### Freq. Tolerance

H5: ± 5 ppm
1: ± 10 ppm
7: ± 15 ppm
2: ± 20 ppm
3: ± 25 ppm
4: ± 30 ppm

### Freq. Stability

U**: ± 10 ppm
G: ± 15 ppm
X: ± 20 ppm
W: ± 25 ppm
Y: ± 30 ppm
H: ± 35 ppm
Q: ± 100 ppm
R: ± 150 ppm

### Packaging

Blank: Bulk  
T: Tape&Reel

### Oscillation Mode

F: Fund. AT>24MHz  
FB: Fund. BT>24MHz

NOTE: Fundamental BT frequency stability ± 100ppm max. at -10° C to +60° C only.  
\* Frequency stability ±50ppm, ±100ppm, ±150ppm only. Contact ABRACON for tighter frequency stability.  
\*\* -10 to +60C only.



# HC/49US (AT49) LOW PROFILE SURFACE MOUNT MICROPROCESSOR CRYSTAL

ABLS2



RoHS  
Compliant

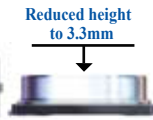
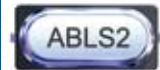

11.4 x 4.7 x 3.3 mm

## OUTLINE DRAWING:

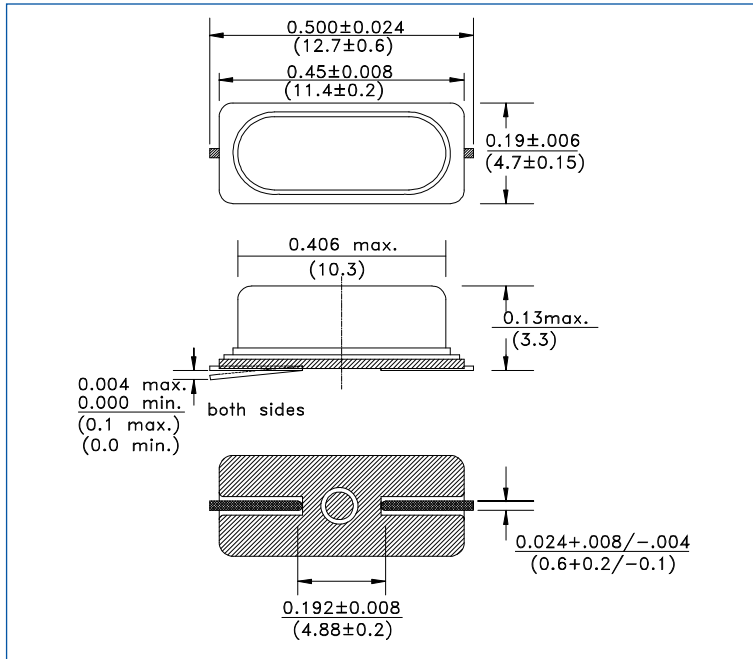

## Recommended land pattern

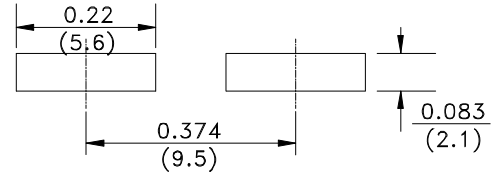

## TAPE & REEL: T = tape and reel (1000pcs/reel)

## Reflow Profile

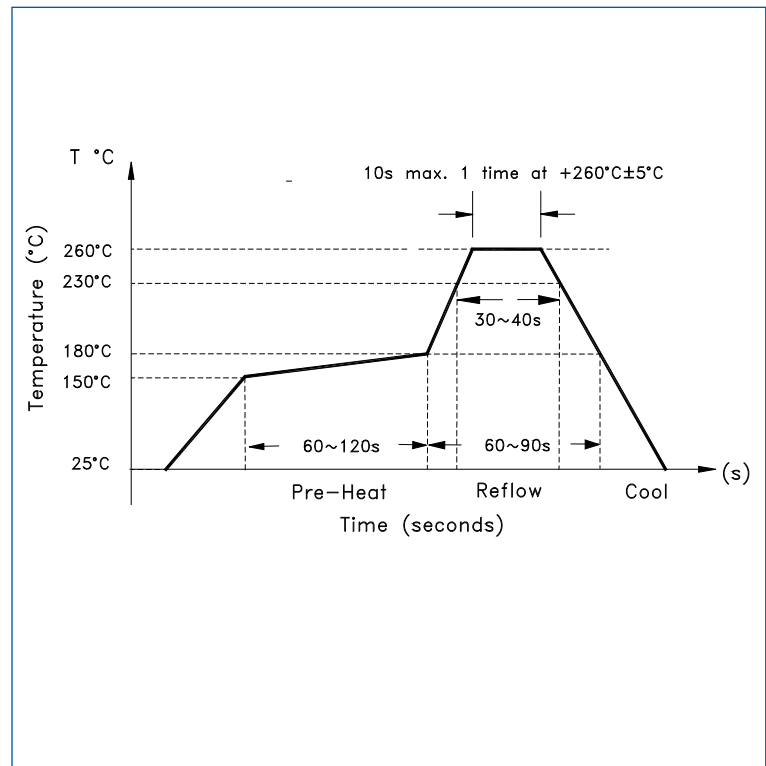
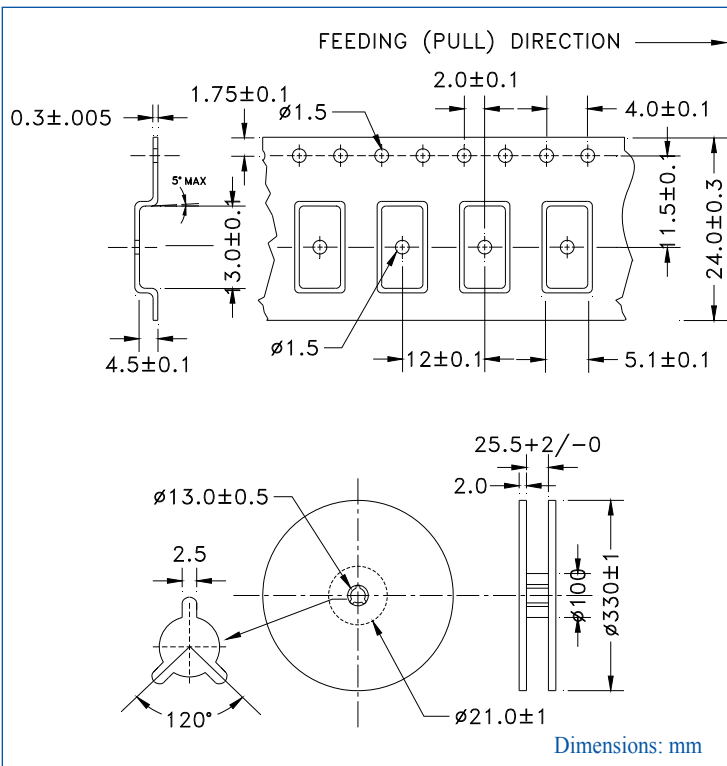

**ATTENTION:** Abracon Corporation's products are COTS – Commercial-Off-The-Shelf products; suitable for Commercial, Industrial and, where designated, Automotive Applications. Abracon's products are not specifically designed for Military, Aviation, Aerospace, Life-dependant Medical applications or any application requiring high reliability where component failure could result in loss of life and/or property. For applications requiring high reliability and/or presenting an extreme operating environment, written consent and authorization from Abracon Corporation is required. Please contact Abracon Corporation for more information.

ABRACON IS  
ISO9001:2008  
CERTIFIED



**ABRACON**  
CORPORATION

Visit [www.abracon.com](http://www.abracon.com) for Terms & Conditions of Sale **Revised: 03.31.11**  
30332 Esperanza, Rancho Santa Margarita, California 92688  
tel 949-546-8000 | fax 949-546-8001 | [www.abracon.com](http://www.abracon.com)