

APPLICATIONS

- ✓ Wireless Communication Circuits
- ✓ RS-422, RS-432 & RS-485
- ✓ Low Voltage ASICs
- ✓ Ethernet - 10/100 Base T

IEC COMPATIBILITY (EN61000-4)

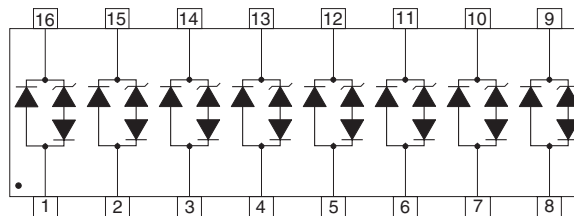
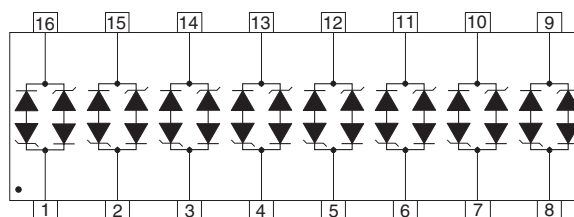
- ✓ 61000-4-2 (ESD): Air - 15kV, Contact - 8kV
- ✓ 61000-4-4 (EFT): 40A - 5/50ns
- ✓ 61000-4-5 (Surge): 12A, 8/20 μ s Level 1 (Line-Ground) & Level 2 (Line-Line)

FEATURES

- ✓ 500 Watts Peak Pulse Power per Line ($t_p=8/20\mu$ s)
- ✓ Unidirectional & Bidirectional Configurations
- ✓ ESD Protection > 40 kilovolts
- ✓ Available in Multiple Voltage Types: 3.3V to 36V
- ✓ Protects up to Eight (8) Lines
- ✓ Low Capacitance: 15pF
- ✓ RoHS Compliant

MECHANICAL CHARACTERISTICS

- ✓ Molded JEDEC SO-16 Package
- ✓ Weight 0.15 grams (Approximate)
- ✓ Available in Lead-Free Pure-Tin Plating(Annealed)
- ✓ Solder Reflow Temperature:
Pure-Tin - Sn, 100: 260-270°C
- ✓ Flammability Rating UL 94V-0
- ✓ 16mm Tape and Reel per EIA Standard 481
- ✓ Marking: Logo, Part Number, Date Code & Pin One Defined By Dot on Top of Package


SO-16
PIN CONFIGURATIONS
UNIDIRECTIONAL CONFIGURATION

BIDIRECTIONAL CONFIGURATION


SM16LC03 thru SM16LC36C

DEVICE CHARACTERISTICS

MAXIMUM RATINGS @ 25°C Unless Otherwise Specified

PARAMETER	SYMBOL	VALUE	UNITS
Peak Pulse Power ($t_p = 8/20\mu s$) - See Figure 1	P_{PP}	500	Watts
Operating Temperature	T_L	-55 to 150	°C
Storage Temperature	T_{STG}	-55 to 150	°C
Forward Voltage @ 50mA, 300µs- Square Wave (Note 1)	V_F	1.5	Volts
Soldering Temperature for 10 seconds	T_{II}	260	°C

Note 1: Only applies to unidirectional devices.

ELECTRICAL CHARACTERISTICS PER LINE @ 25°C Unless Otherwise Specified

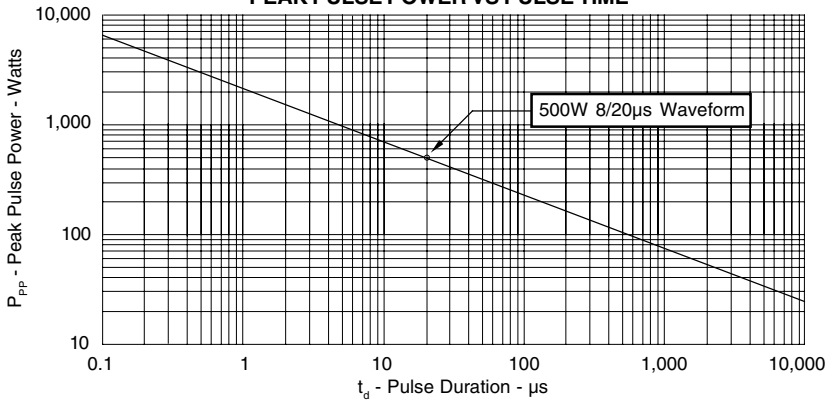
PART NUMBER (See Note 1)	RATED STAND-OFF VOLTAGE V_{WM} VOLTS	MINIMUM BREAKDOWN VOLTAGE @ 1mA $V_{(BR)}$ VOLTS	MAXIMUM CLAMPING VOLTAGE (See Fig. 2) @ $I_P = 1A$ V_C VOLTS	MAXIMUM CLAMPING VOLTAGE (See Fig. 2) @ 8/20µs $V_C @ I_{PP}$	MAXIMUM LEAKAGE CURRENT @ V_{WM} I_b µA	MAXIMUM CAPACITANCE 0V @ 1 MHz C pF	TEMPERATURE COEFFICIENT OF $V_{(BR)}$ $qV_{(BR)}$ mV/°C
SM16LC03	3.3	4.5	7.0	20.0V @ 35A	125	15	-3
SM16LC03C	3.3	4.5	7.0	20.0V @ 35A	125	15	-3
SM16LC05	5.0	6.0	9.8	24.0V @ 42A	20	15	3
SM16LC05C	5.0	6.0	9.8	24.0V @ 42A	20	15	3
SM16LC08	8.0	8.5	13.4	26.0V @ 30A	10	15	9
SM16LC08C	8.0	8.5	13.4	26.0V @ 30A	10	15	9
SM16LC12	12.0	13.3	19.0	33.0V @ 21A	2	15	16
SM16LC12C	12.0	13.3	19.0	33.0V @ 21A	2	15	16
SM16LC15	15.0	16.7	25.5	39.0V @ 15A	2	15	17
SM16LC15C	15.0	16.7	25.5	39.0V @ 15A	2	15	17
SM16LC24	24.0	26.7	40.0	57.0V @ 10A	2	15	26
SM16LC24C	24.0	26.7	40.0	57.0V @ 10A	2	15	26
SM16LC36	36.0	40.0	53.0	72.0V @ 7.0A	2	15	36
SM16LC36C	36.0	40.0	53.0	72.0V @ 7.0A	2	15	36

Note 1: Part numbers with a "C" suffix are bidirectional devices, i.e., SM16LC05C.

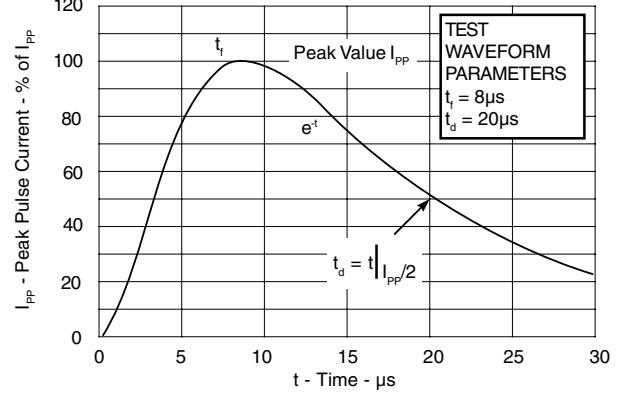
SM16LC03 thru SM16LC36C

GRAPHS

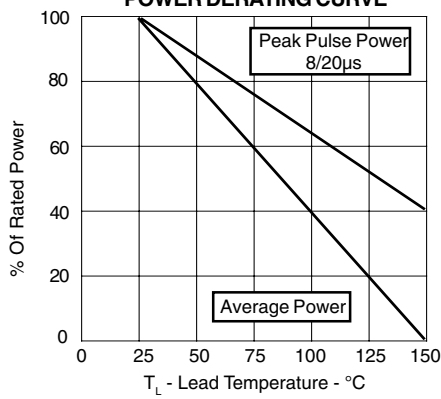
**FIGURE 1
PEAK PULSE POWER VS PULSE TIME**



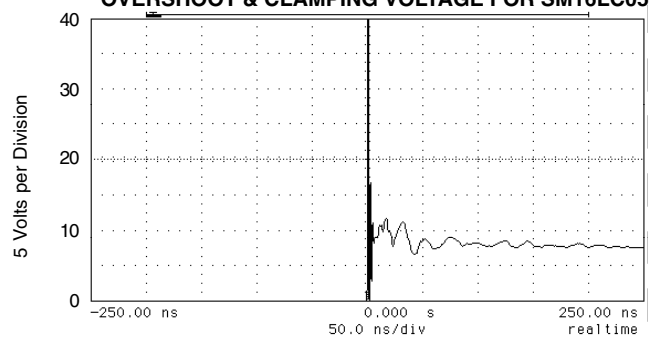
**FIGURE 2
PULSE WAVE FORM**



**FIGURE 3
POWER DERATING CURVE**

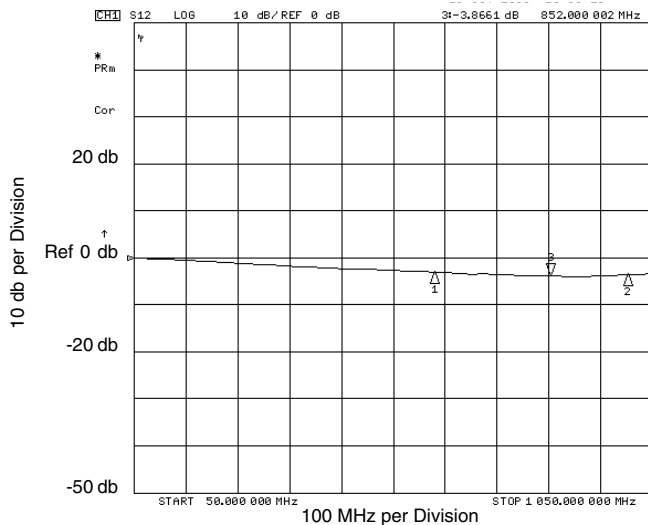


**FIGURE 4
OVERSHOOT & CLAMPING VOLTAGE FOR SM16LC05**

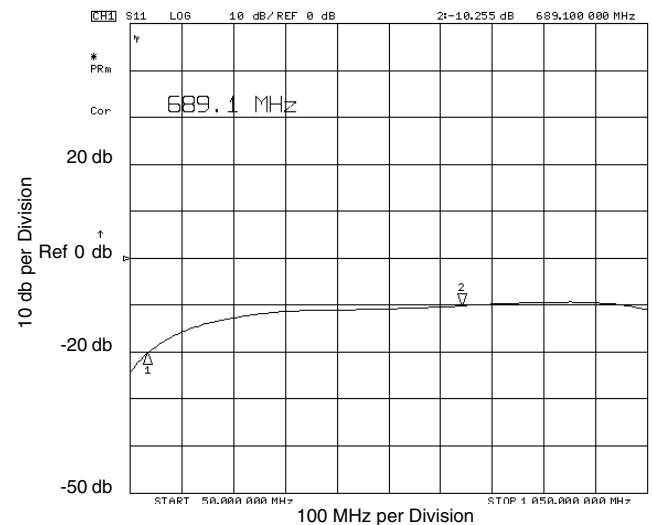


ESD Test Pulse: 25 kilovolt, 1/30ns (waveform)

**FIGURE 5
INSERTION LOSS - SM16LC12**



**FIGURE 6
RETURN LOSS - SM16LC12**



SM16LC03 thru SM16LC36C

APPLICATION NOTE

The SM16LC & SM16LCxxC Series are TVS arrays designed to protect I/O or data lines from the damaging effects of ESD, EFT and other types of surges. This product series provides both unidirectional and bidirectional protection, with a surge capability of 500 Watts P_{PP} per line for an 8/20 μ s waveform and ESD protection > 40kV.

BIDIRECTIONAL COMMON-MODE CONFIGURATION (Figure 1)

Ideal for RS-485 applications, the SM16LCxxC Series provides up to eight (8) lines of protection in a common-mode configuration as depicted in Figure 1. This low capacitance series allows the transceiver or telecommunications circuit to operate safely without significant signal distortion.

Circuit connectivity is as follows:

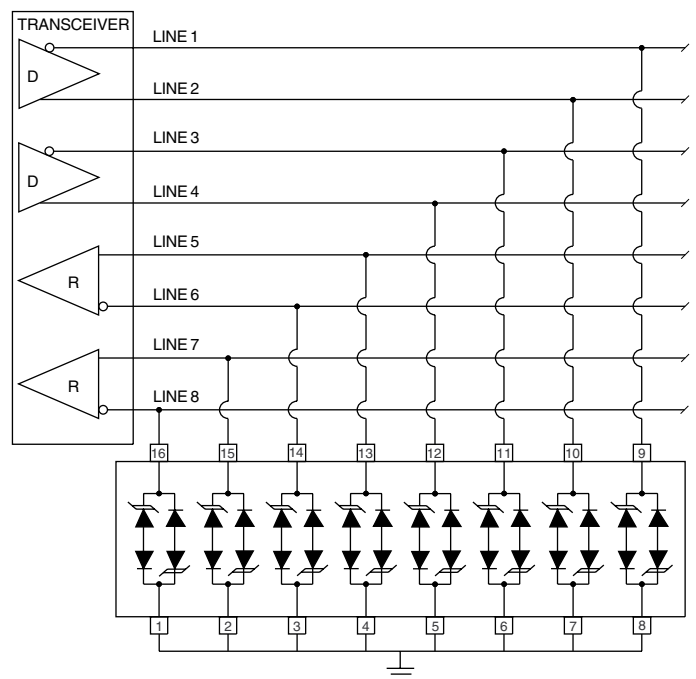
- ✓ Lines 1 is connected to Pin 9.
- ✓ Line 2 is connected to Pin 10.
- ✓ Line 3 is connected to Pin 11.
- ✓ Line 4 is connected to Pin 12.
- ✓ Line 5 is connected to Pin 13.
- ✓ Line 6 is connected to Pin 14.
- ✓ Line 7 is connected to Pin 15.
- ✓ Line 8 is connected to Pin 16.
- ✓ Pins 1-8 are connected to ground.

CIRCUIT BOARD LAYOUT RECOMMENDATIONS

Circuit board layout is critical for Electromagnetic Compatibility (EMC) protection. The following guidelines are recommended:

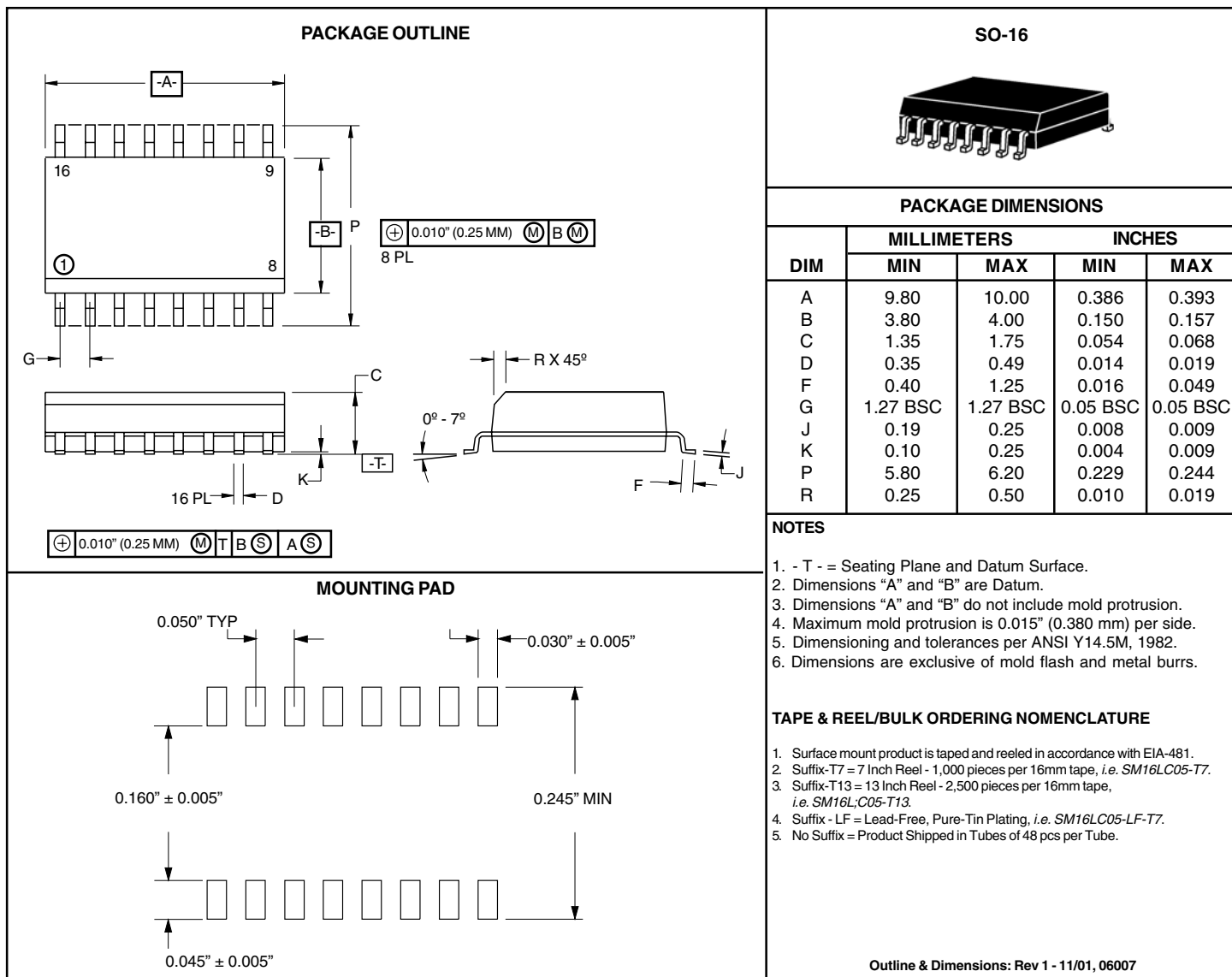
- ✓ The protection device should be placed near the input terminals or connectors, the device will divert the transient current immediately before it can be coupled into the nearby traces.
- ✓ The path length between the TVS device and the protected line should be minimized.
- ✓ All conductive loops including power and ground loops should be minimized.
- ✓ The transient current return path to ground should be kept as short as possible to reduce parasitic inductance.
- ✓ Ground planes should be used whenever possible. For multilayer PCBs, use ground vias.

Figure 1. Bidirectional Common-Mode Protection



SM16LC03 thru SM16LC36C

SO-16 PACKAGE OUTLINE & DIMENSIONS



COPYRIGHT © ProTek Devices 2007

SPECIFICATIONS: ProTek reserves the right to change the electrical and or mechanical characteristics described herein without notice (except JEDEC).

DESIGN CHANGES: ProTek reserves the right to discontinue product lines without notice, and that the final judgement concerning selection and specifications is the buyer's and that in furnishing engineering and technical assistance, ProTek assumes no responsibility with respect to the selection or specifications of such products.

ProTek Devices

2929 South Fair Lane, Tempe, AZ 85282

Tel: 602-431-8101 Fax: 602-431-2288

E-Mail: sales@protekdevices.com

Web Site: www.protekdevices.com