

## Features

- Low Turn-on Voltage
- Fast Switching
- PN Junction Guard Ring for Transient and ESD Protection
- **Lead Free/RoHS Compliant (Note 3)**
- **“Green” Molding Compound (No Br, Sb) (Note 4)**
- **Qualified to AEC-Q101 Standards for High Reliability**

## Mechanical Data

- Case: SOT-23
- Case Material: Molded Plastic, “Green” Molding Compound. UL Flammability Classification Rating 94V-0
- Moisture Sensitivity: Level 1 per J-STD-020
- Terminals: Matte Tin Finish annealed over Alloy 42 leadframe (Lead Free Plating). Solderable per MIL-STD-202, Method 208
- Polarity: See Diagrams Below
- Marking Information: See Page 3
- Ordering Information: See Page 2
- Weight: 0.008 grams (approximate)



Top View

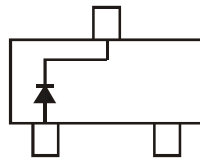

BAT54

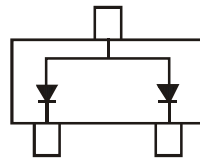

BAT54A

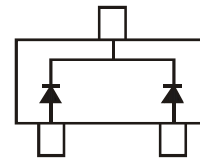

BAT54C

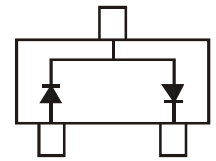

BAT54S

## Maximum Ratings @<sub>TA</sub> = 25°C unless otherwise specified

Characteristic	Symbol	Value	Unit
Peak Repetitive Reverse Voltage	$V_{RRM}$	30	V
Working Peak Reverse Voltage	$V_{RWM}$		
DC Blocking Voltage	$V_R$		
Forward Continuous Current (Note 2)	$I_F$	200	mA
Repetitive Peak Forward Current	$I_{FRM}$	300	mA
Forward Surge Current @ $t < 1.0s$	$I_{FSM}$	600	mA

## Thermal Characteristics

Characteristic	Symbol	Value	Unit
Power Dissipation (Note 2)	$P_D$	200	mW
Thermal Resistance, Junction to Ambient Air (Note 2)	$R_{\theta JA}$	500	°C/W
Operating and Storage Temperature Range (Note 5)	$T_J, T_{STG}$	-65 to +150	°C

## Electrical Characteristics @<sub>TA</sub> = 25°C unless otherwise specified

Characteristic	Symbol	Min	Typ	Max	Unit	Test Condition
Reverse Breakdown Voltage (Note 1)	$V_{(BR)R}$	30	—	—	V	$I_{RS} = 100\mu A$
Forward Voltage	$V_F$	—	—	240	mV	$I_F = 0.1mA$
				320		$I_F = 1mA$
				400		$I_F = 10mA$
				500		$I_F = 30mA$
				800		$I_F = 100mA$
Reverse Leakage Current (Note 1)	$I_R$	—	—	2.0	$\mu A$	$V_R = 25V$
Total Capacitance	$C_T$	—	—	10	pF	$V_R = 1.0V, f = 1.0MHz$
Reverse Recovery Time	$t_{rr}$	—	—	5.0	ns	$I_F = 10mA$ through $I_R = 10mA$ to $I_R = 1.0mA, R_L = 100\Omega$

- Notes:
1. Short duration test pulse used to minimize self-heating effect.
  2. Part mounted on FR-4 board with recommended pad layout, which can be found on our website at <http://www.diodes.com/datasheets/ap02001.pdf>.
  3. No purposefully added lead.
  4. Products manufactured with date code VD (Week 50, 2008) and newer are built with Green Molding Compound. Products manufactured with date code prior to VD are built with Non-Green Molding Compound and may contain Halogens or  $Sb_2O_3$  Fire Retardants.
  5. The heat generated must be less than the thermal conductivity from Junction-to-Ambient:  $dP_D/dT_J < 1/R_{\theta JA}$

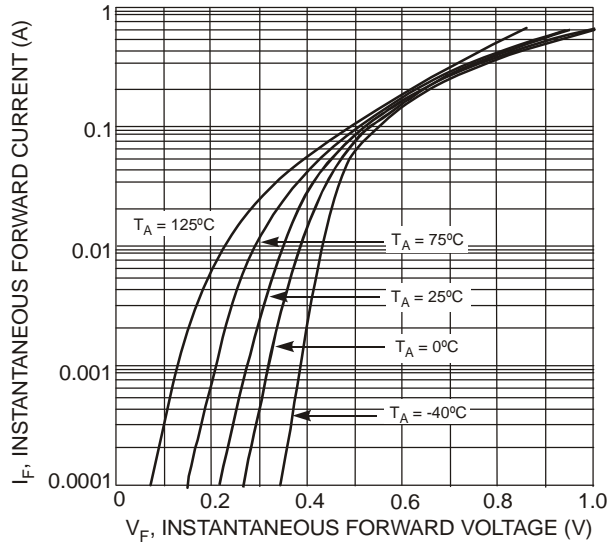

Fig. 1 Typical Forward Characteristics

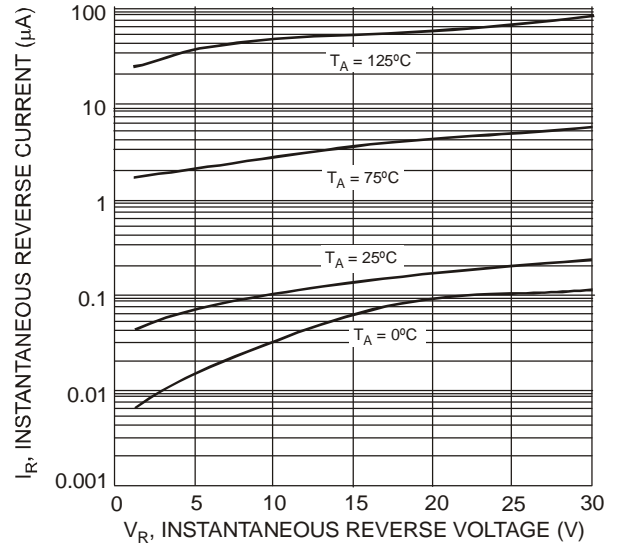

Fig. 2 Typical Reverse Characteristics

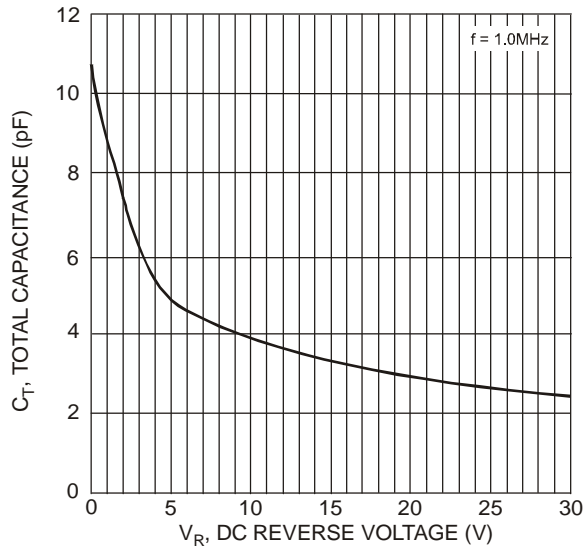

Fig. 3 Total Capacitance vs. Reverse Voltage

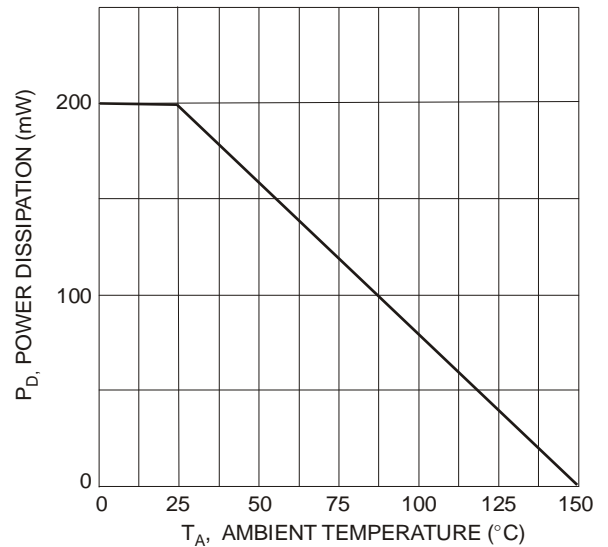

Fig. 4 Power Derating Curve

**Ordering Information** (Note 6)

Part Number	Case	Packaging
BAT54-7-F	SOT-23	3000/Tape & Reel
BAT54A-7-F	SOT-23	3000/Tape & Reel
BAT54C-7-F	SOT-23	3000/Tape & Reel
BAT54S-7-F	SOT-23	3000/Tape & Reel

Notes: 6. For packaging details, go to our website at <http://www.diodes.com/datasheets/ap02007.pdf>.

**Marking Information**

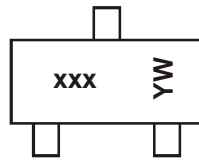

xxx = Product Type Marking Code  
 KL1 = BAT54  
 KL2 = BAT54A  
 KL3 = BAT54C  
 KL4 = BAT54S  
 YM = Date Code Marking  
 Y = Year (ex: T = 2006)  
 M = Month (ex: 9 = September)

Date Code Key

Year	1998	1999	2000	2001	2002	2003	2004	2005	2006	2007	2008	2009	2010	2011	2012	2013	2014	2015
Code	J	K	L	M	N	P	R	S	T	U	V	W	X	Y	Z	A	B	C

Month	Jan	Feb	Mar	Apr	May	Jun	Jul	Aug	Sep	Oct	Nov	Dec
Code	1	2	3	4	5	6	7	8	9	O	N	D

**Package Outline Dimensions**

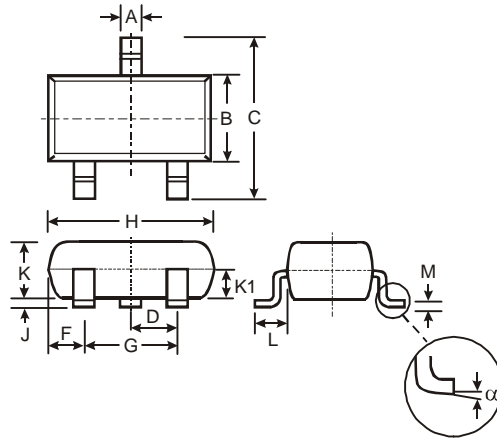

SOT-23			
Dim	Min	Max	Typ
A	0.37	0.51	0.40
B	1.20	1.40	1.30
C	2.30	2.50	2.40
D	0.89	1.03	0.915
F	0.45	0.60	0.535
G	1.78	2.05	1.83
H	2.80	3.00	2.90
J	0.013	0.10	0.05
K	0.903	1.10	1.00
K1	-	-	0.400
L	0.45	0.61	0.55
M	0.085	0.18	0.11
α	0°	8°	-

All Dimensions in mm

**Suggested Pad Layout**

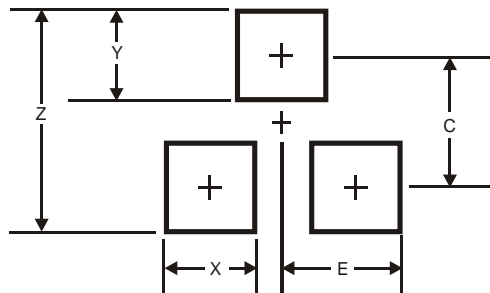

Dimensions	Value (in mm)
Z	2.9
X	0.8
Y	0.9
C	2.0
E	1.35

**IMPORTANT NOTICE**

DIODES INCORPORATED MAKES NO WARRANTY OF ANY KIND, EXPRESS OR IMPLIED, WITH REGARDS TO THIS DOCUMENT, INCLUDING, BUT NOT LIMITED TO, THE IMPLIED WARRANTIES OF MERCHANTABILITY AND FITNESS FOR A PARTICULAR PURPOSE (AND THEIR EQUIVALENTS UNDER THE LAWS OF ANY JURISDICTION).

Diodes Incorporated and its subsidiaries reserve the right to make modifications, enhancements, improvements, corrections or other changes without further notice to this document and any product described herein. Diodes Incorporated does not assume any liability arising out of the application or use of this document or any product described herein; neither does Diodes Incorporated convey any license under its patent or trademark rights, nor the rights of others. Any Customer or user of this document or products described herein in such applications shall assume all risks of such use and will agree to hold Diodes Incorporated and all the companies whose products are represented on Diodes Incorporated website, harmless against all damages.

Diodes Incorporated does not warrant or accept any liability whatsoever in respect of any products purchased through unauthorized sales channel. Should Customers purchase or use Diodes Incorporated products for any unintended or unauthorized application, Customers shall indemnify and hold Diodes Incorporated and its representatives harmless against all claims, damages, expenses, and attorney fees arising out of, directly or indirectly, any claim of personal injury or death associated with such unintended or unauthorized application.

Products described herein may be covered by one or more United States, international or foreign patents pending. Product names and markings noted herein may also be covered by one or more United States, international or foreign trademarks.

**LIFE SUPPORT**

Diodes Incorporated products are specifically not authorized for use as critical components in life support devices or systems without the express written approval of the Chief Executive Officer of Diodes Incorporated. As used herein:

A. Life support devices or systems are devices or systems which:

1. are intended to implant into the body, or
2. support or sustain life and whose failure to perform when properly used in accordance with instructions for use provided in the labeling can be reasonably expected to result in significant injury to the user.

B. A critical component is any component in a life support device or system whose failure to perform can be reasonably expected to cause the failure of the life support device or to affect its safety or effectiveness.

Customers represent that they have all necessary expertise in the safety and regulatory ramifications of their life support devices or systems, and acknowledge and agree that they are solely responsible for all legal, regulatory and safety-related requirements concerning their products and any use of Diodes Incorporated products in such safety-critical, life support devices or systems, notwithstanding any devices- or systems-related information or support that may be provided by Diodes Incorporated. Further, Customers must fully indemnify Diodes Incorporated and its representatives against any damages arising out of the use of Diodes Incorporated products in such safety-critical, life support devices or systems.

Copyright © 2010, Diodes Incorporated

[www.diodes.com](http://www.diodes.com)