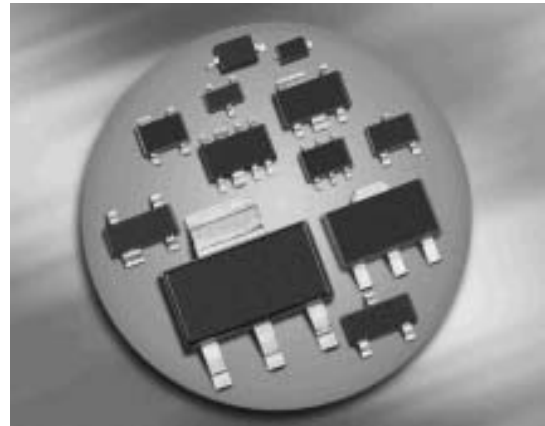
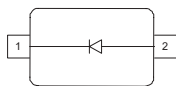
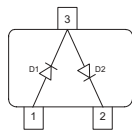
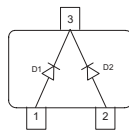
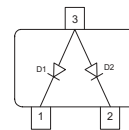

**Silicon PIN Diodes**

- PIN diode for high speed switching of RF signals
- Very low forward resistance (low insertion loss)
- Very low capacitance (high isolation)
- For frequencies up to 3GHz
- Pb-free (RoHS compliant) package<sup>1)</sup>
- Qualified according AEC Q101

**BAR63-02..**  
**BAR63-03W**

**BAR63-04**  
**BAR63-04W**

**BAR63-05**  
**BAR63-05W**

**BAR63-06**  
**BAR63-06W**

Type	Package	Configuration	$L_S$ (nH)	Marking
BAR63-02L	TSLP-2-1	single, leadless	0.4	G
BAR63-02V	SC79	single	0.6	G
BAR63-02W	SCD80	single	0.6	GG
BAR63-03W	SOD323	single	1.8	G
BAR63-04	SOT23	series	1.8	G4s
BAR63-04W	SOT323	series	1.4	G4s
BAR63-05	SOT23	common cathode	1.8	G5s
BAR63-05W	SOT323	common cathode	1.4	G5s
BAR63-06	SOT23	common anode	1.8	G6s
BAR63-06W	SOT323	common anode	1.4	G6s

<sup>1</sup>Pb-containing package may be available upon special request

**Maximum Ratings** at  $T_A = 25^\circ\text{C}$ , unless otherwise specified

Parameter	Symbol	Value	Unit
Diode reverse voltage	$V_R$	50	V
Forward current	$I_F$	100	mA
Total power dissipation BAR63-02L, $T_S \leq 118^\circ\text{C}$ BAR63-02V, -02W, BAR63-03W, $T_S \leq 115^\circ\text{C}$ BAR63-04...BAR63-06, $T_S \leq 55^\circ\text{C}$ BAR63-04S, $T_S \leq 115^\circ\text{C}$ BAR63-04W...BAR63-06W, $T_S \leq 105^\circ\text{C}$	$P_{\text{tot}}$	250 250 250 250 250	mW
Junction temperature	$T_j$	150	°C
Operating temperature range	$T_{\text{op}}$	-55 ... 125	
Storage temperature	$T_{\text{stg}}$	-55 ... 150	

**Thermal Resistance**

Parameter	Symbol	Value	Unit
Junction - soldering point <sup>1)</sup> BAR63-02L BAR63-02V, BAR63-02W BAR63-03W BAR63-04...BAR63-06 BAR63-04S BAR63-04W...BAR63-06W	$R_{\text{thJS}}$	$\leq 125$ $\leq 140$ $\leq 155$ $\leq 380$ $\leq 180$ $\leq 180$	K/W

**Electrical Characteristics** at  $T_A = 25^\circ\text{C}$ , unless otherwise specified

Parameter	Symbol	Values			Unit
		min.	typ.	max.	
<b>DC Characteristics</b>					
Breakdown voltage $I_{(\text{BR})} = 5 \mu\text{A}$	$V_{(\text{BR})}$	50	-	-	V
Reverse current $V_R = 35 \text{ V}$	$I_R$	-	-	10	nA
Forward voltage $I_F = 100 \text{ mA}$	$V_F$	-	0.95	1.2	V

<sup>1)</sup>For calculation of  $R_{\text{thJA}}$  please refer to the Technical Information

**Electrical Characteristics** at  $T_A = 25^\circ\text{C}$ , unless otherwise specified

Parameter	Symbol	Values			Unit
		min.	typ.	max.	
<b>AC Characteristics</b>					
Diode capacitance $V_R = 5\text{ V}$ , $f = 1\text{ MHz}$ $V_R = 0\text{ V}$ , 100 MHz ... 1.8 GHz	$C_T$	-	0.21	0.3	pF
Reverse parallel resistance $V_R = 0\text{ V}$ , $f = 100\text{ MHz}$ $V_R = 0\text{ V}$ , $f = 1\text{ GHz}$ $V_R = 0\text{ V}$ , $f = 1.8\text{ GHz}$	$R_P$	-	500	-	k $\Omega$
Forward resistance $I_F = 5\text{ mA}$ , $f = 100\text{ MHz}$ $I_F = 10\text{ mA}$ , $f = 100\text{ MHz}$	$r_f$	-	1.2	2	$\Omega$
Charge carrier life time $I_F = 10\text{ mA}$ , $I_R = 6\text{ mA}$ , measured at $I_R = 3\text{ mA}$ , $R_L = 100\ \Omega$	$\tau_{rr}$	-	75	-	ns
I-region width	$W_I$	-	4.5	-	$\mu\text{m}$
Insertion loss <sup>1)</sup> $I_F = 1\text{ mA}$ , $f = 1.8\text{ GHz}$ $I_F = 5\text{ mA}$ , $f = 1.8\text{ GHz}$ $I_F = 10\text{ mA}$ , $f = 1.8\text{ GHz}$	$I_L$	-	0.15	-	dB
Isolation <sup>1)</sup> $V_R = 0\text{ V}$ , $f = 0.9\text{ GHz}$ $V_R = 0\text{ V}$ , $f = 1.8\text{ GHz}$ $V_R = 0\text{ V}$ , $f = 2.45\text{ GHz}$	$I_{SO}$	-	17.9	-	

<sup>1)</sup>BAR63-02L in series configuration,  $Z = 50\ \Omega$

**Diode capacitance  $C_T = f(V_R)$**

$f = 1\text{MHz} - 1.8\text{GHz}$

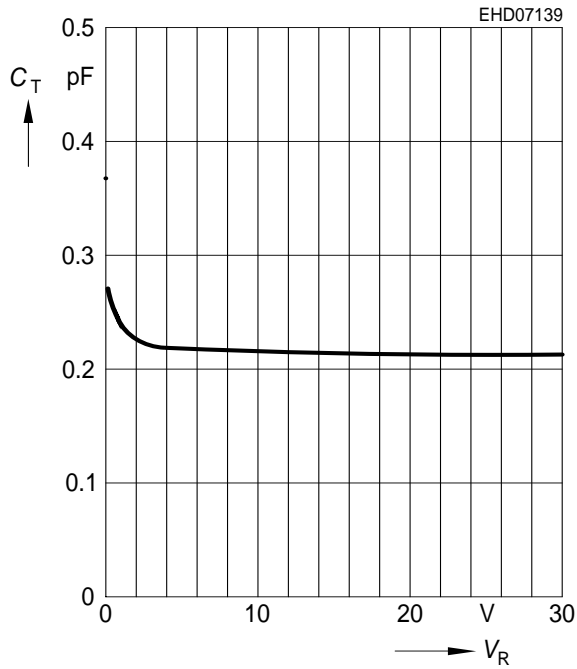

**Reverse parallel resistance  $R_p = f(V_R)$**

$f = \text{Parameter}$

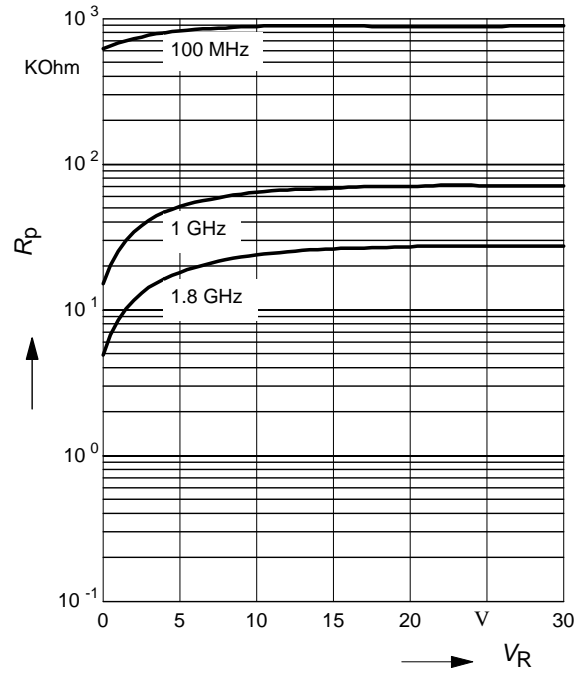

**Forward resistance  $r_f = f(I_F)$**

$f = 100\text{MHz}$

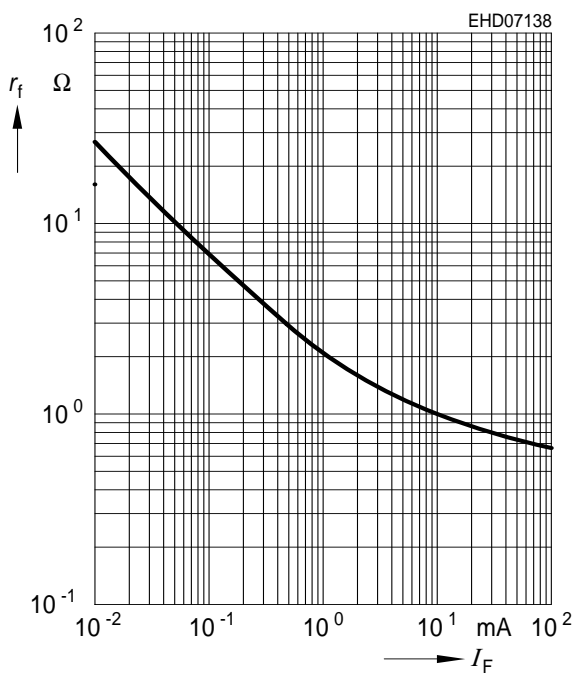

**Forward current  $I_F = f(V_F)$**

$T_A = \text{Parameter}$

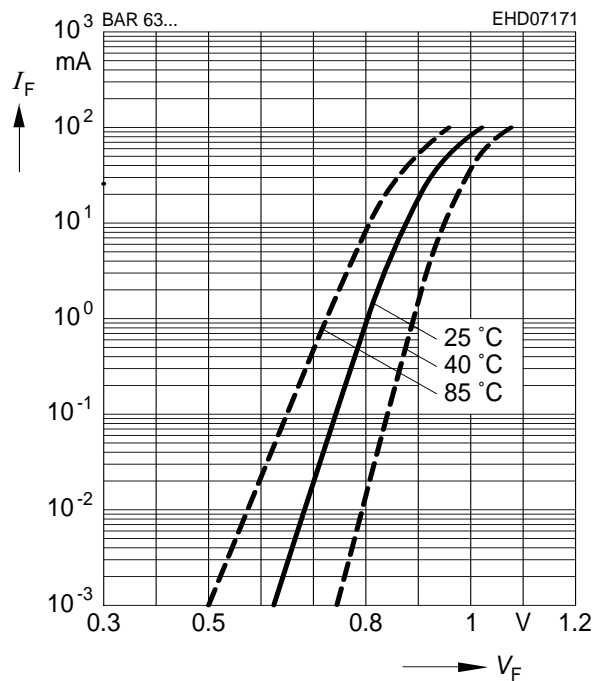

**Forward current  $I_F = f(T_S)$**

BAR63-04...BAR63-06

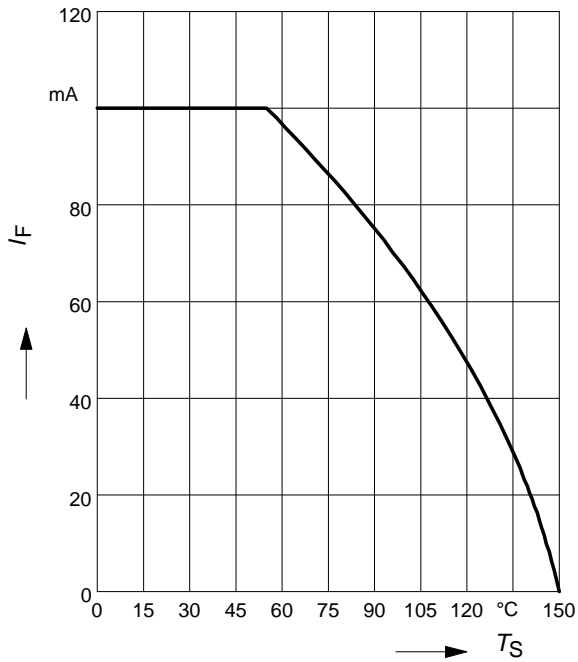

**Forward current  $I_F = f(T_S)$**

BAR63-02V, BAR63-02W

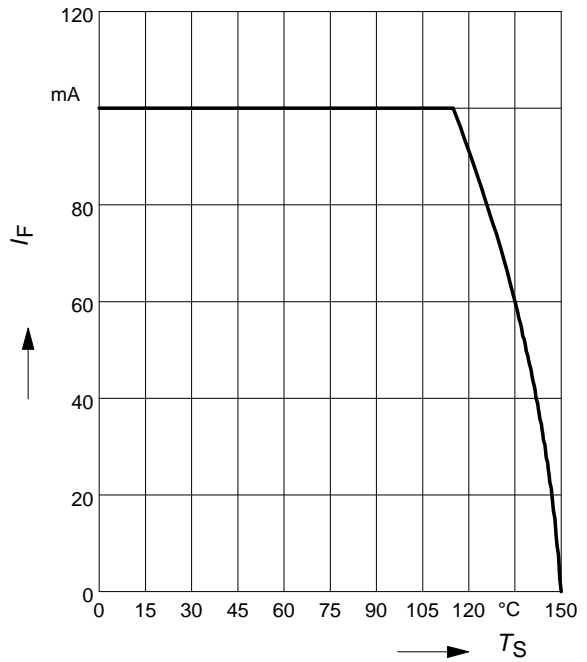

**Forward current  $I_F = f(T_S)$**

BAR63-03W

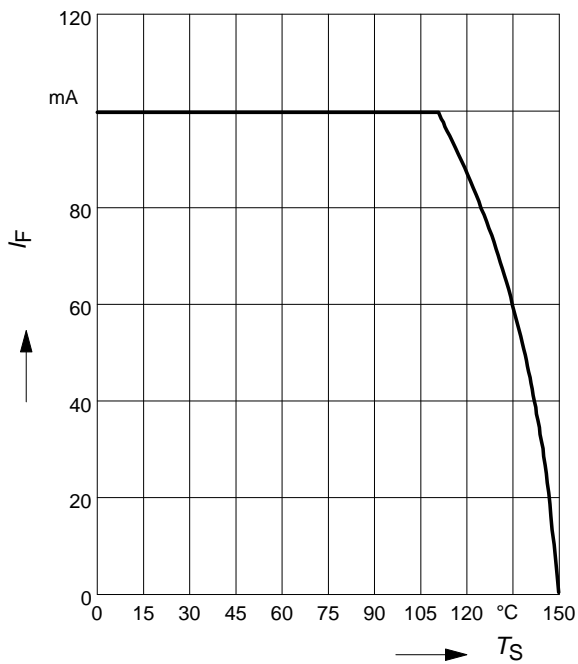

**Forward current  $I_F = f(T_S)$**

BAR63-04W...BAR63-06W

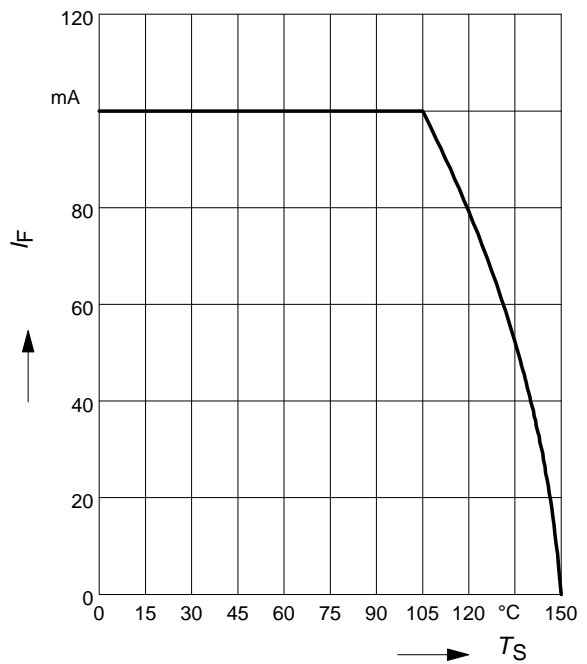

**Permissible Puls Load  $R_{thJS} = f(t_p)$**

BAR63-04...BAR63-06

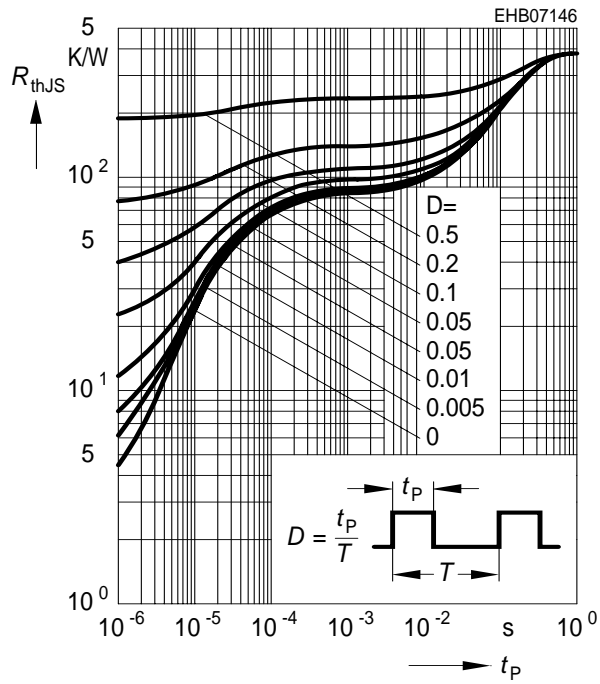

**Permissible Pulse Load**

$I_{Fmax} / I_{FDC} = f(t_p)$

BAR63-04...BAR63-06

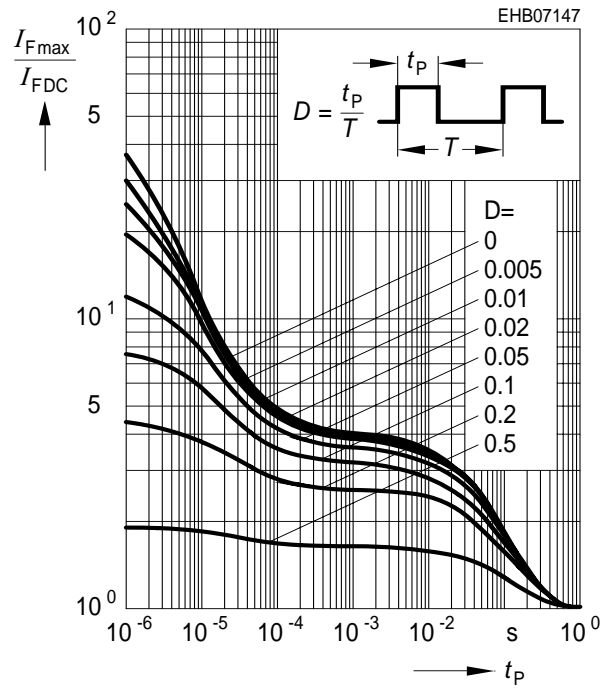

**Permissible Puls Load  $R_{thJS} = f(t_p)$**

BAR63-02V, BAR63-02W

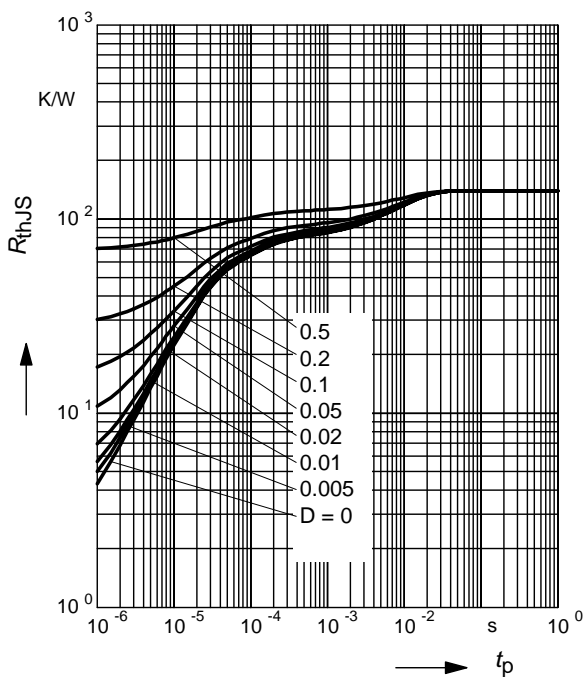

**Permissible Pulse Load**

$I_{Fmax} / I_{FDC} = f(t_p)$

BAR63-02V, BAR63-02W

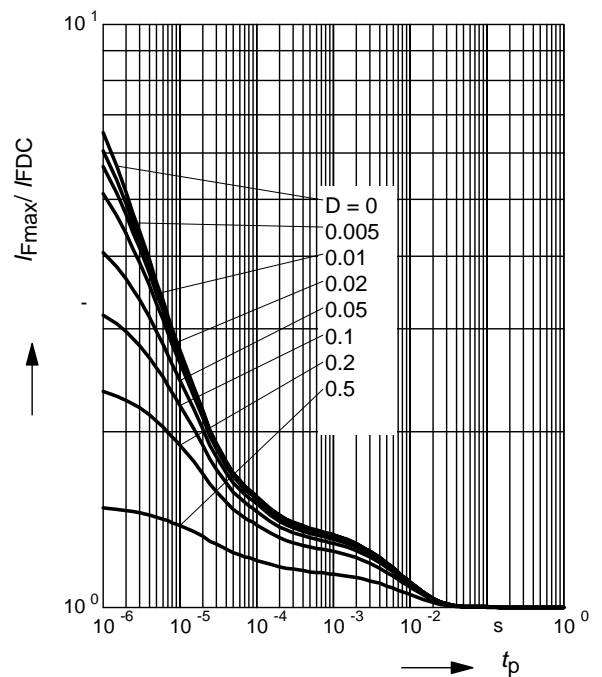

Permissible Puls Load  $R_{thJS} = f(t_p)$

BAR63-03W

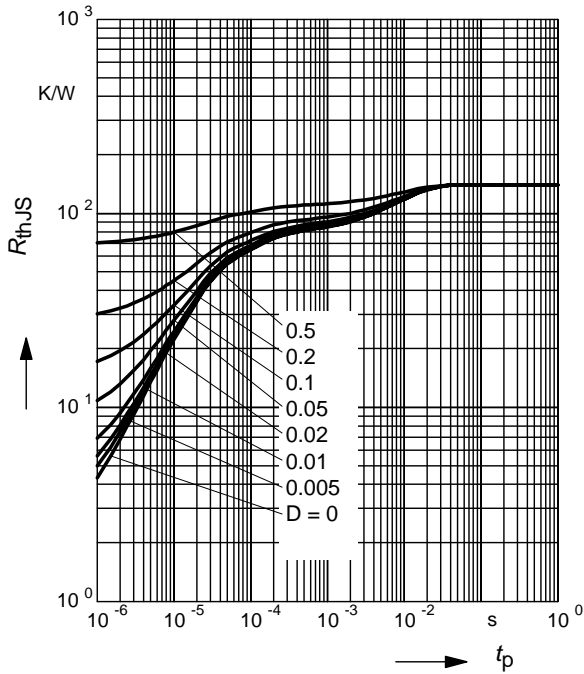

Permissible Pulse Load

$I_{Fmax} / I_{FDC} = f(t_p)$

BAR63-03W

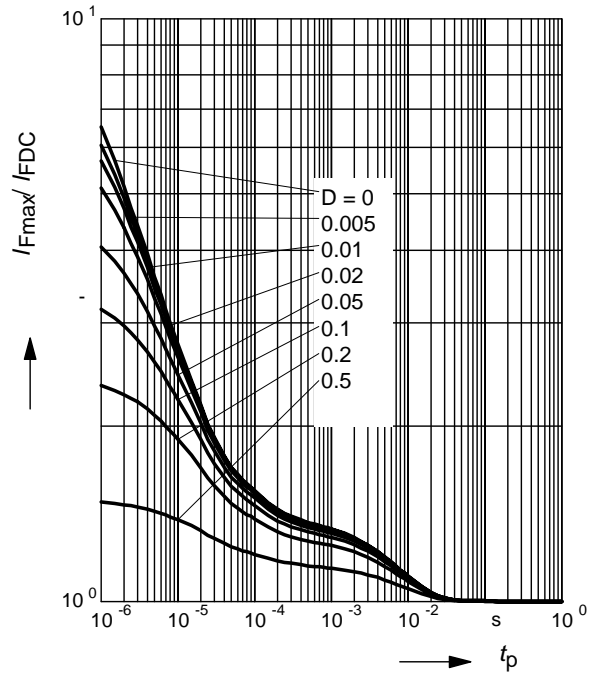

Permissible Puls Load  $R_{thJS} = f(t_p)$

BAR63-04W...BAR63-06W

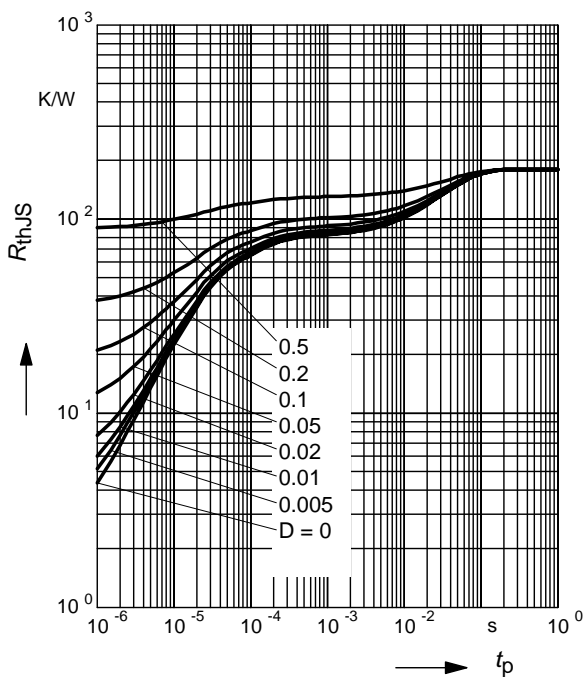

Permissible Pulse Load

$I_{Fmax} / I_{FDC} = f(t_p)$

BAR63-04W...BAR63-06W

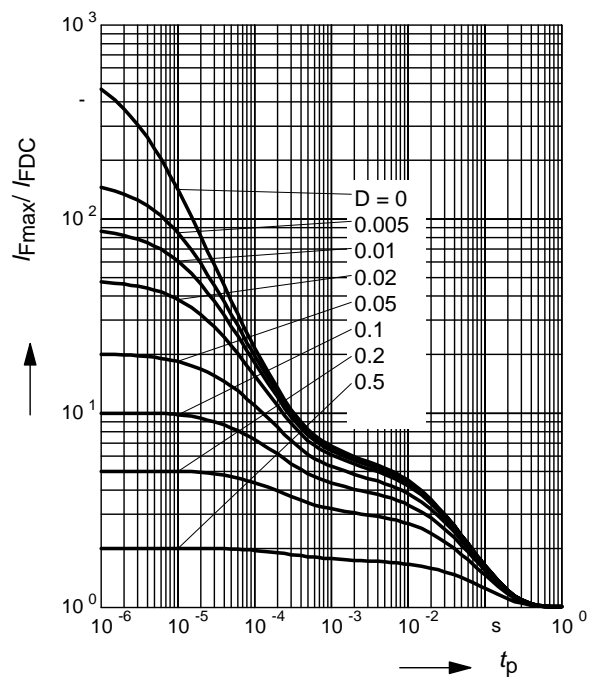

**Insertion loss**  $I_L = -|S_{21}|^2 = f(f)$

$I_F$  = Parameter

BAR63-02L in series configuration,  $Z = 50\Omega$

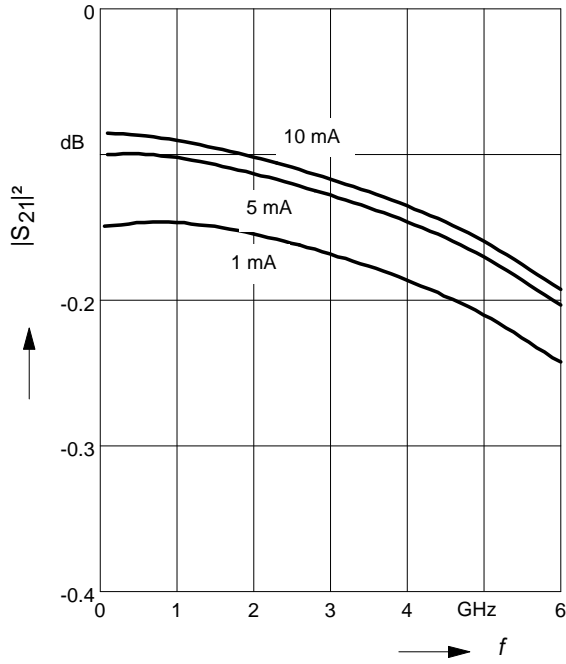

**Isolation**  $I_{SO} = -|S_{21}|^2 = f(f)$

$V_R$  = Parameter

BAR63-02L in series configuration,  $Z = 50\Omega$

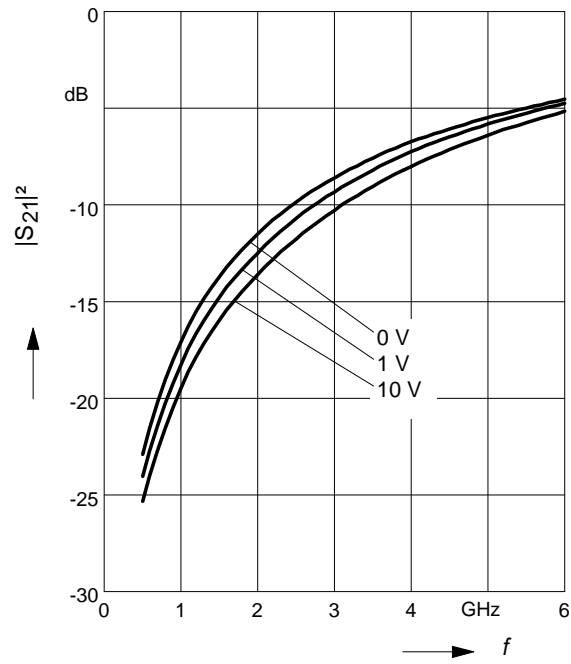



Package Outline

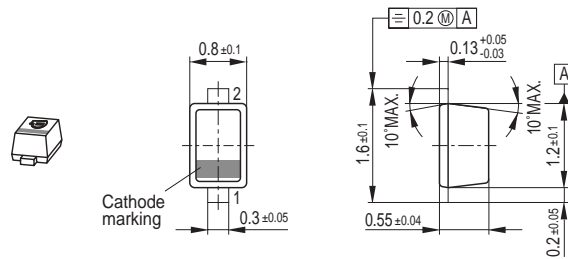

Foot Print



Marking Layout (Example)

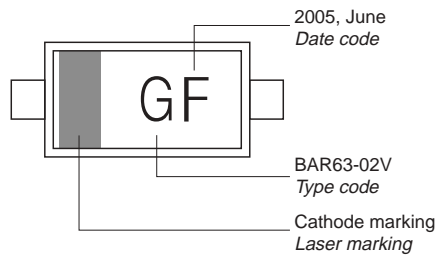

Standard Packing

- Reel  $\varnothing$ 180 mm = 3.000 Pieces/Reel
- Reel  $\varnothing$ 180 mm = 8.000 Pieces/Reel (2 mm Pitch)
- Reel  $\varnothing$ 330 mm = 10.000 Pieces/Reel

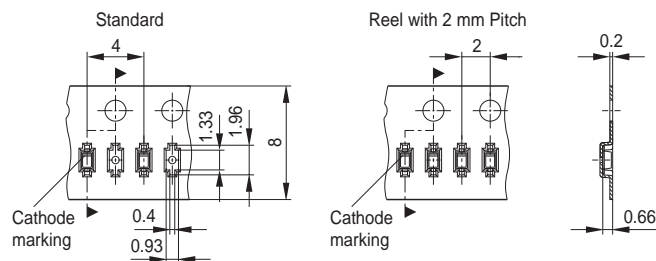

Package Outline

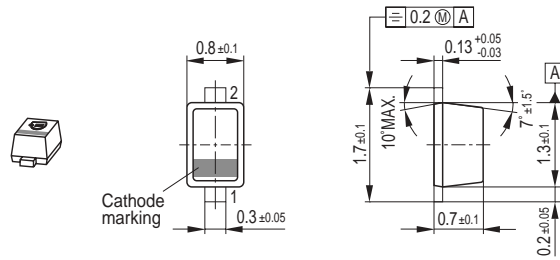

Foot Print

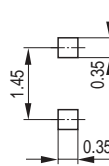

Marking Layout (Example)

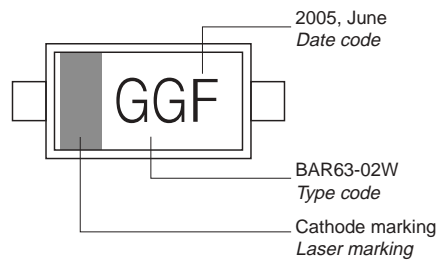

Standard Packing

Reel  $\varnothing$ 180 mm = 3.000 Pieces/Reel  
 Reel  $\varnothing$ 180 mm = 8.000 Pieces/Reel (2 mm Pitch)  
 Reel  $\varnothing$ 330 mm = 10.000 Pieces/Reel

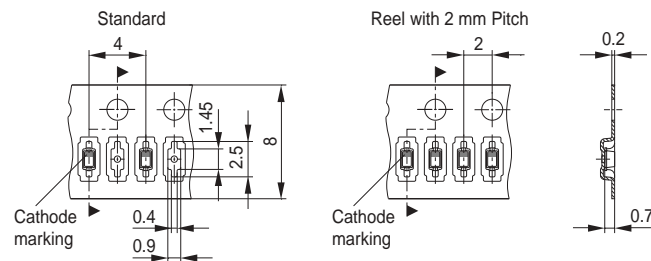

Date Code marking for discrete packages with  
one digit (SCD80, SC79, SC75<sup>1)</sup>) CES-Code

Month	2003	2004	2005	2006	2007	2008	2009	2010	2011	2012	2013	2014
01	a	p	A	P	a	p	A	P	a	p	A	P
02	b	q	B	Q	b	q	B	Q	b	q	B	Q
03	c	r	C	R	c	r	C	R	c	r	C	R
04	d	s	D	S	d	s	D	S	d	s	D	S
05	e	t	E	T	e	t	E	T	e	t	E	T
06	f	u	F	U	f	u	F	U	f	u	F	U
07	g	v	G	V	g	v	G	V	g	v	G	V
08	h	x	H	X	h	x	H	X	h	x	H	X
09	j	y	J	Y	j	y	J	Y	j	y	J	Y
10	k	z	K	Z	k	z	K	Z	k	z	K	Z
11	l	2	L	4	l	2	L	4	l	2	L	4
12	n	3	N	5	n	3	N	5	n	3	N	5

1) New Marking Layout for SC75, implemented at October 2005.

Package Outline

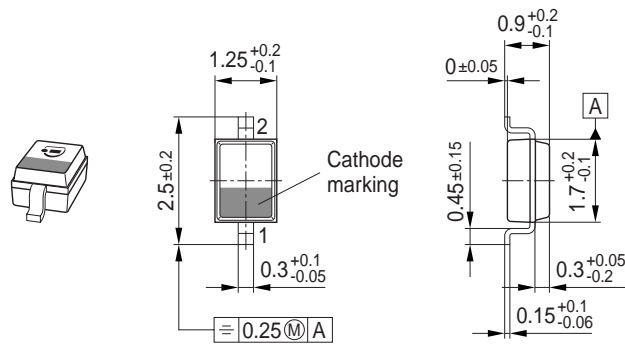

Foot Print

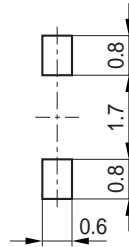

Marking Layout (Example)

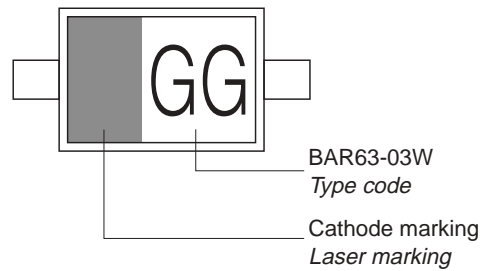

Standard Packing

Reel  $\varnothing 180$  mm = 3.000 Pieces/Reel  
Reel  $\varnothing 330$  mm = 10.000 Pieces/Reel

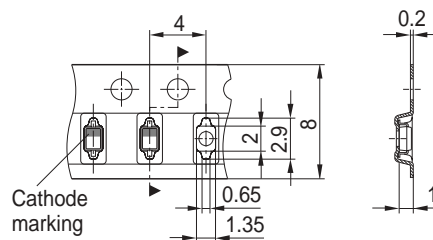

Package Outline

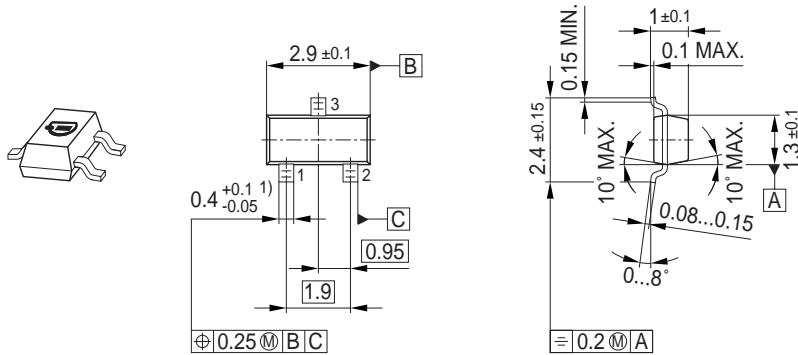

1) Lead width can be 0.6 max. in dambar area

Foot Print

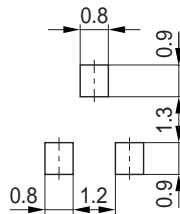

Marking Layout (Example)

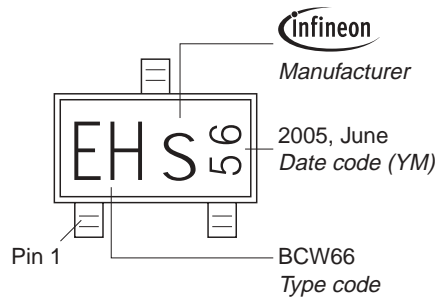

Standard Packing

Reel ø180 mm = 3.000 Pieces/Reel  
 Reel ø330 mm = 10.000 Pieces/Reel

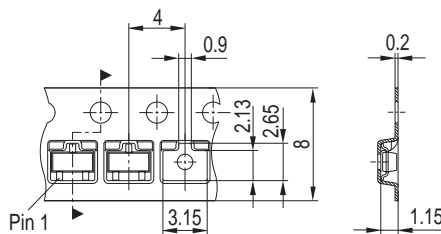

Package Outline

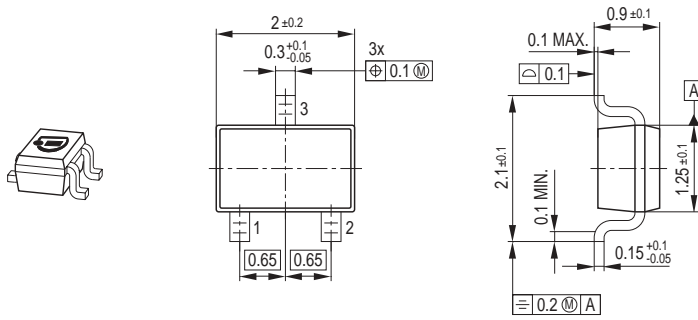

Foot Print

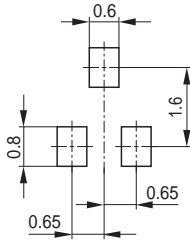

Marking Layout (Example)

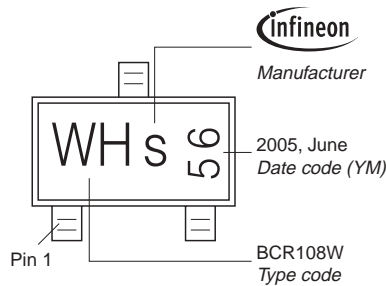

Standard Packing

Reel  $\varnothing 180 \text{ mm} = 3.000 \text{ Pieces/Reel}$   
 Reel  $\varnothing 330 \text{ mm} = 10.000 \text{ Pieces/Reel}$

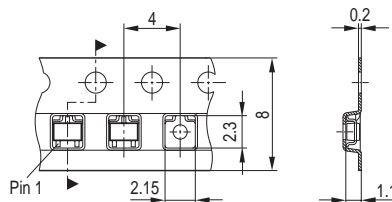

### Package Outline

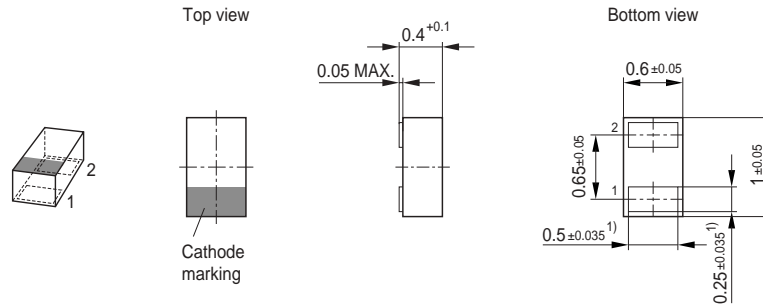

1) Dimension applies to plated terminal

### Foot Print

For board assembly information please refer to Infineon website "Packages"

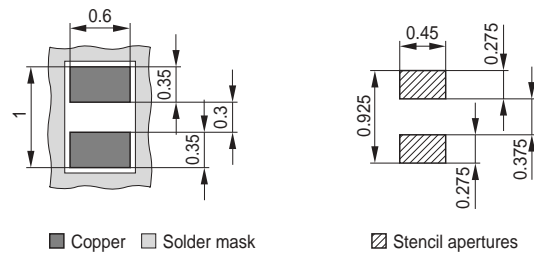

### Marking Layout (Example)

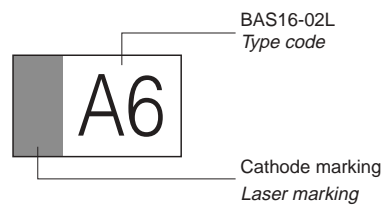

### Standard Packing

Reel  $\varnothing$ 180 mm = 15.000 Pieces/Reel  
 Reel  $\varnothing$ 330 mm = 50.000 Pieces/Reel (optional)

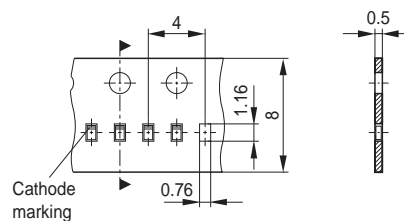

Edition 2006-02-01  
Published by  
Infineon Technologies AG  
81726 München, Germany  
© Infineon Technologies AG 2007.  
All Rights Reserved.

### **Attention please!**

The information given in this dokument shall in no event be regarded as a guarantee of conditions or characteristics ("Beschaffheitsgarantie"). With respect to any examples or hints given herein, any typical values stated herein and/or any information regarding the application of the device, Infineon Technologies hereby disclaims any and all warranties and liabilities of any kind, including without limitation warranties of non-infringement of intellectual property rights of any third party.

### **Information**

For further information on technology, delivery terms and conditions and prices please contact your nearest Infineon Technologies Office ([www.infineon.com](http://www.infineon.com)).

### **Warnings**

Due to technical requirements components may contain dangerous substances. For information on the types in question please contact your nearest Infineon Technologies Office.

Infineon Technologies Components may only be used in life-support devices or systems with the express written approval of Infineon Technologies, if a failure of such components can reasonably be expected to cause the failure of that life-support device or system, or to affect the safety or effectiveness of that device or system.

Life support devices or systems are intended to be implanted in the human body, or to support and/or maintain and sustain and/or protect human life. If they fail, it is reasonable to assume that the health of the user or other persons may be endangered.