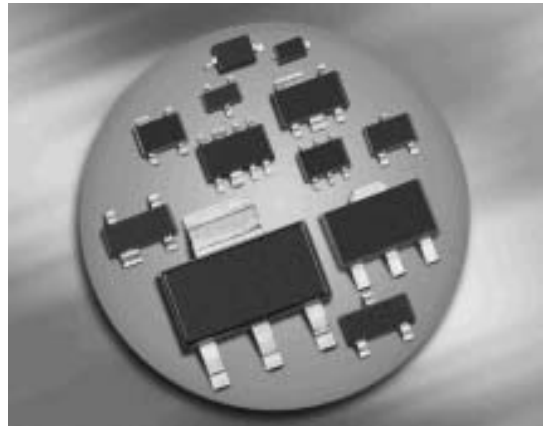
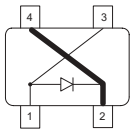

Silicon RF Switching Diode

- Designed for use in shunt configuration in high performance RF switches
- High shunt signal isolation
- Low shunt insertion loss
- Optimized for short - open transformation using $\lambda/4$ lines
- Pb-free (RoHS compliant) package ¹⁾
- Qualified according AEC Q101

BAR81W

Type	Package	Configuration	L_S (nH)	Marking
BAR81W	SOT343	single shunt-diode	0.15*	BBs

* series inductance chip to ground

Maximum Ratings at $T_A = 25^\circ\text{C}$, unless otherwise specified

Parameter	Symbol	Value	Unit
Diode reverse voltage	V_R	30	V
Forward current	I_F	100	mA
Total power dissipation $T_S \leq 138^\circ\text{C}$	P_{tot}	100	mW
Junction temperature	T_j	150	°C
Operating temperature range	T_{op}	-55 ... 125	
Storage temperature	T_{stg}	-55 ... 150	

Thermal Resistance

Parameter	Symbol	Value	Unit
Junction - soldering point ²⁾	R_{thJS}	≤ 120	K/W

¹⁾Pb-containing package may be available upon special request

²⁾For calculation of R_{thJA} please refer to Application Note Thermal Resistance

Electrical Characteristics at $T_A = 25^\circ\text{C}$, unless otherwise specified

Parameter	Symbol	Values			Unit
		min.	typ.	max.	
DC Characteristics					
Reverse current $V_R = 20\text{ V}$	I_R	-	-	20	nA
Forward voltage $I_F = 100\text{ mA}$	V_F	-	0.93	1	V
AC Characteristics					
Diode capacitance $V_R = 1\text{ V}, f = 1\text{ MHz}$ $V_R = 3\text{ V}, f = 1\text{ MHz}$	C_T	-	0.6 0.57	1 0.9	pF
Forward resistance $I_F = 5\text{ mA}, f = 100\text{ MHz}$	r_f	-	0.7	1	Ω
Charge carrier life time $I_F = 10\text{ mA}, I_R = 6\text{ mA}$, measured at $I_R = 3\text{ mA}$, $R_L = 100\ \Omega$	τ_{rr}	-	80	-	ns
I-region width	W_I	-	3.5	-	μm
Shunt Insertion loss ¹⁾ $I_F = 10\text{ mA}, f = 1.89\text{ GHz}$	I_L	-	30	-	dB
Shunt isolation ¹⁾ $V_R = 3\text{ V}, f = 1.89\text{ GHz}$	I_{SO}	-	0.7	-	

Configuration of the shunt-diode

- A perfect ground is essential for optimum isolation
- The anode pins should be used as passage for RF

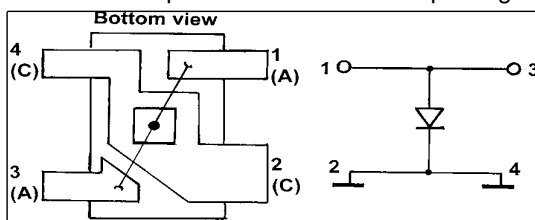
¹For more information please refer to Application Note 049.

Diode capacitance $C_T = f(V_R)$

$f =$ Parameter

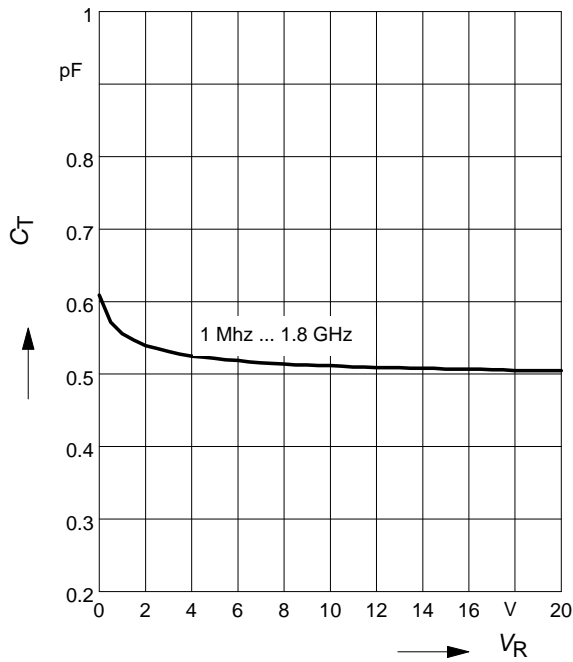

Reverse parallel resistance $R_P = f(V_R)$

$f =$ Parameter

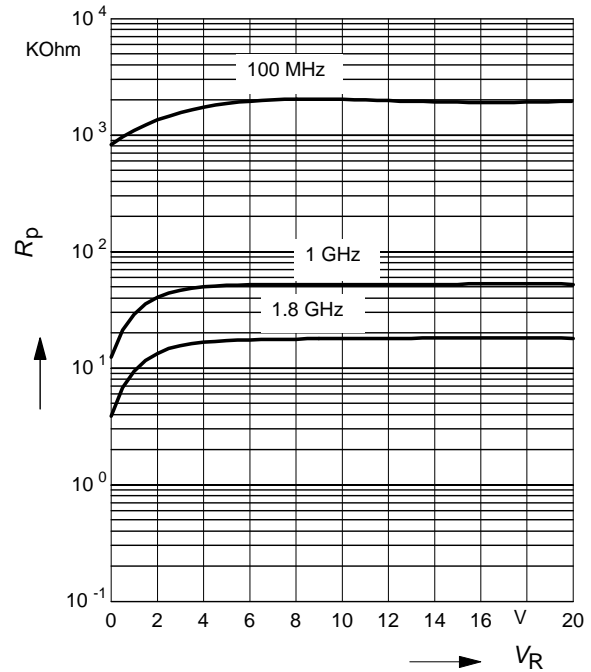

Forward resistance $r_f = f(I_F)$

$f = 100\text{MHz}$

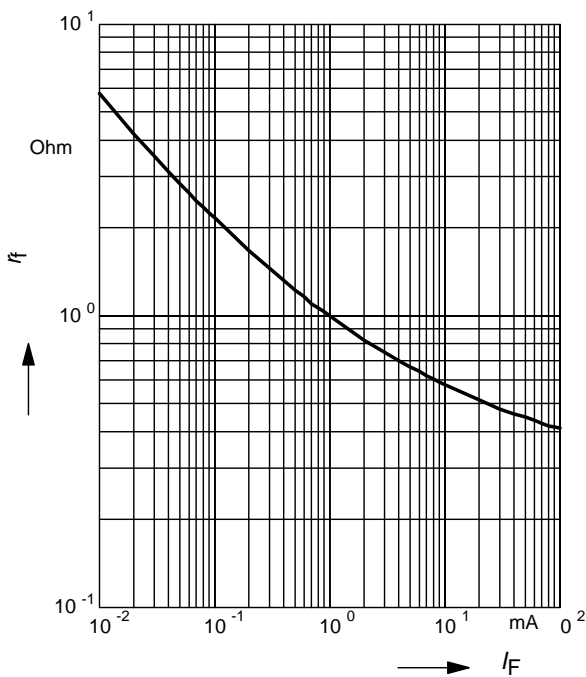

Forward current $I_F = f(V_F)$

$T_A =$ Parameter

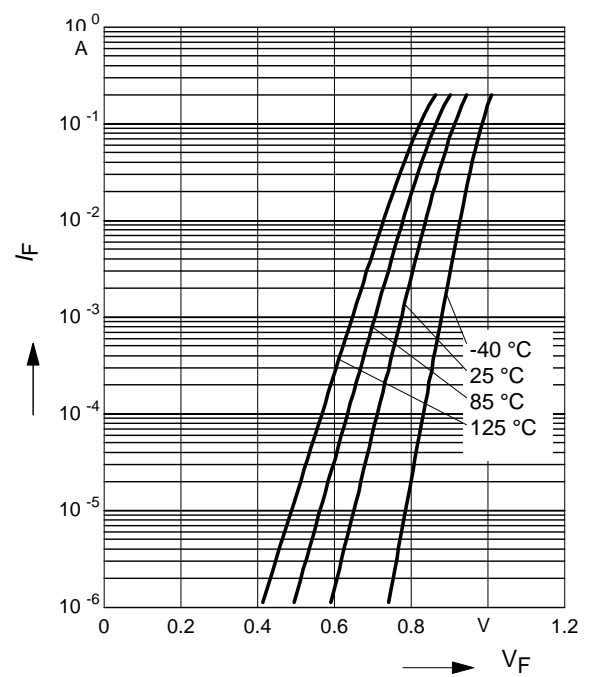

Forward current $I_F = f(T_S)$

BAR81W

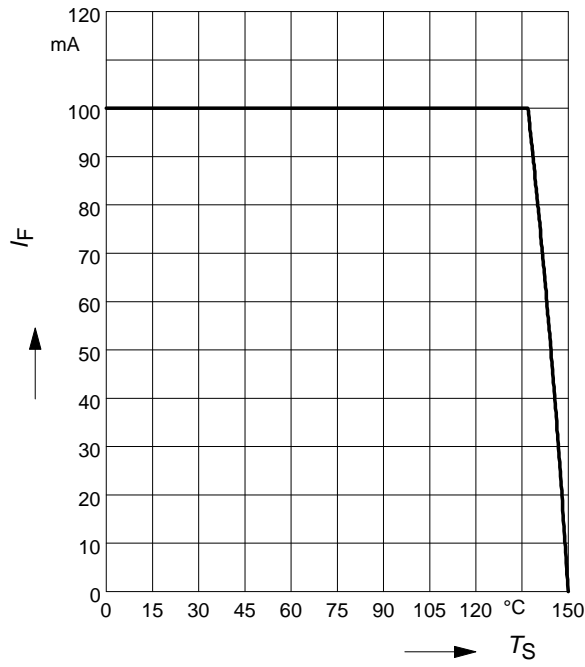

Permissible Puls Load $R_{thJS} = f(t_p)$

BAR81W

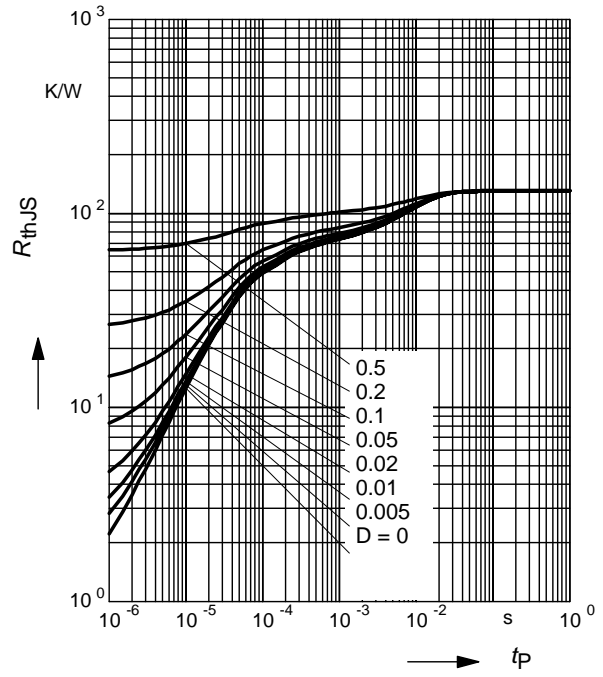

Permissible Pulse Load

$I_{Fmax} / I_{FDC} = f(t_p)$ BAR81W

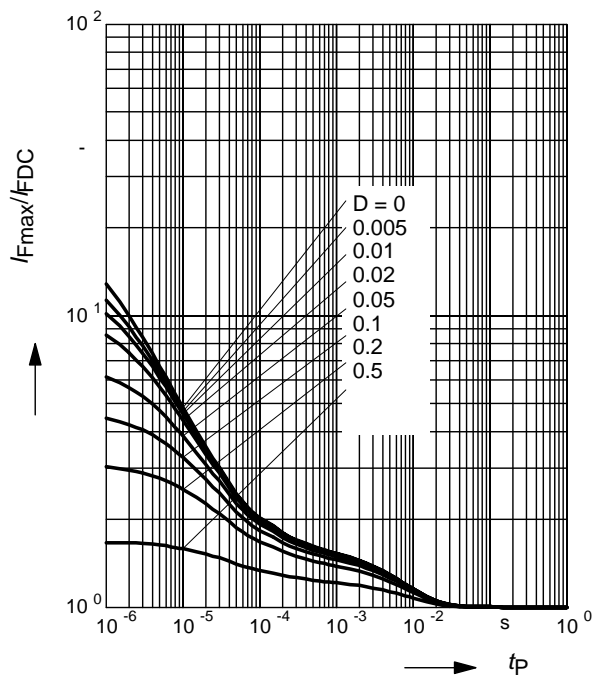

Package Outline

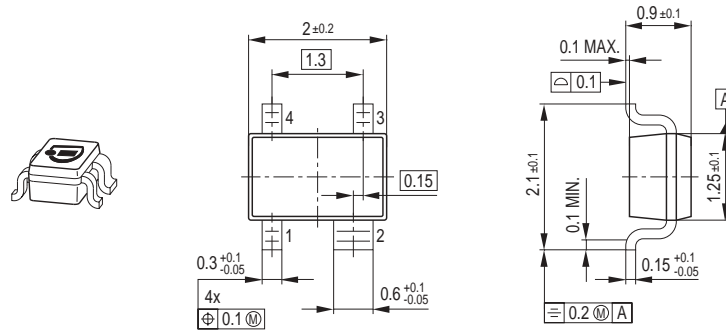

Foot Print

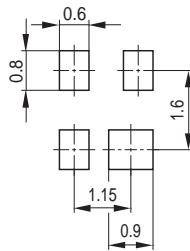

Marking Layout (Example)

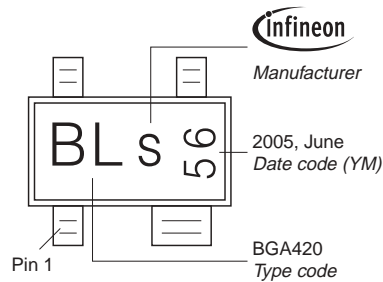

Standard Packing

Reel ø180 mm = 3.000 Pieces/Reel
 Reel ø330 mm = 10.000 Pieces/Reel

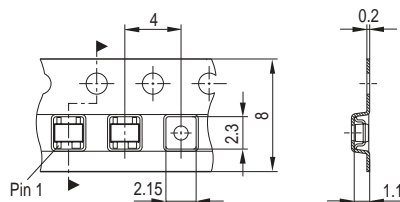

Edition 2006-02-01
Published by
Infineon Technologies AG
81726 München, Germany
© Infineon Technologies AG 2007.
All Rights Reserved.

Attention please!

The information given in this dokument shall in no event be regarded as a guarantee of conditions or characteristics ("Beschaffenhheitsgarantie"). With respect to any examples or hints given herein, any typical values stated herein and/or any information regarding the application of the device, Infineon Technologies hereby disclaims any and all warranties and liabilities of any kind, including without limitation warranties of non-infringement of intellectual property rights of any third party.

Information

For further information on technology, delivery terms and conditions and prices please contact your nearest Infineon Technologies Office (www.infineon.com).

Warnings

Due to technical requirements components may contain dangerous substances. For information on the types in question please contact your nearest Infineon Technologies Office.

Infineon Technologies Components may only be used in life-support devices or systems with the express written approval of Infineon Technologies, if a failure of such components can reasonably be expected to cause the failure of that life-support device or system, or to affect the safety or effectiveness of that device or system.

Life support devices or systems are intended to be implanted in the human body, or to support and/or maintain and sustain and/or protect human life. If they fail, it is reasonable to assume that the health of the user or other persons may be endangered.