



UM7500

POWER PIN DIODES

DESCRIPTION

The UM7500 series features Microsemi's innovative passivated chip design which takes advantage of the latest silicon wafer bonding and junction passivation techniques. This new series of PIN diodes incorporates all of the desirable RF properties of previous Microsemi diodes plus extremely low leakages and very stable reverse characteristics. Power dissipation capability is assured by Microsemi's metallurgically bonded, fused in glass construction. This technique continues to be the optimum approach for applications requiring reliable, high power diodes.

Low leakage distortion is achieved by maintaining high carrier lifetime and accurately controlling I-region thickness throughout the process. The UM7500 series is designed for use in a broad range of RF and microwave switch and attenuator circuits. The packages make this series suitable for many high-end medical applications such as MRI and CAT scan equipment. For military applications, the new series is capable of meeting all the requirements of MIL-STD-750 including HTRB screening at 80% of rated voltage at 150 °C.

KEY FEATURES

- Voltage Ratings to 1400 Volt
- Fully Passivated PIN Chip
- Low Leakage, IR < 0.5 μA
- Void Less, Particle Free Construction
- Hermetic Fused in Glass
- Low Loss, Low Distortion
- Surface Mount Package Available
- Metallurgically Bonded, Thermally Matched Construction
- Compatible with automatic insertion equipment

IMPORTANT: For the most current data, consult MICROSEMI's website: <http://www.microsemi.com>

ABSOLUTE MAXIMUM RATINGS AT 25° C (UNLESS OTHERWISE SPECIFIED)

Package	Condition	PD	θ
A	25 °C Pin Temperature	10 W	15 °C/W
B & E	½ in. total length to 25 °C Contact Free Air	5.5 W	27.5 °C/W 1.5 W
C	25 °C Stud Temperature	10 W	15 °C/W
D	25 °C Stud Temperature	7.5 W	20 °C/W
SM	25 °C End Cap Temperature	7.5 W	20 °C/W
All	1 us pulse (Single)	35 kW	
OPERATING AND STORAGE TEMPERATURE RANGE		-65 °C to + 175 °C	

APPLICATIONS/BENEFITS

- Isolated stud package available
- Surface mount package available
- RoHS compliant packaging available: use UMX7501B, etc.

VOLTAGE RATINGS

Reverse Voltage @ 0.5 uA

100V	UM7501
200V	UM7502
400V	UM7504
600V	UM7506
800V	UM7508
1000V	UM7510
1200V	UM7512
1400V	UM7514

ELECTRICAL PARAMETERS @ 25°C (unless otherwise specified)

Parameter	Symbol	Conditions	MIN.	TYPICAL	MAX.	Units
Total Capacitance	CT	$V_R=100V, F=1\text{ MHz}$		0.8	1.0	pF
Series Resistance	R_S	$I_f=50\text{ mA}, F=100\text{ MHz}$		0.8	1.0	Ohms
Parallel Resistance	R_p	$V_R=100\text{ V}, F=100\text{ MHz}$	100k	150k		Ohms
Parallel Resistance	R_p	$V_R=0\text{ V}, F=100\text{ MHz}$	10k	15k		Ohms
Carrier Lifetime	τ	$I_F=10\text{ mA}$	2.5	3.5		μs
Reverse Current	I_R	$V_R = \text{Voltage rating}$		0.1	0.5	μA
I-Region Width	W	-		100		μm
Forward Voltage	V_F	$I_f=50\text{ mA}$		0.8	1.0	
Forward Bias Harmonic Distortion	(R2a/a,R3a/a)	100 MHz, P=30W, $I_F=50\text{mA}$	80	90		dBc
Reverse Bias Harmonic Distortion	(R2a/a,R3a/a)	100 MHz, P=0dBm, $V_R=0V$	60	70		dBc

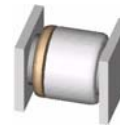
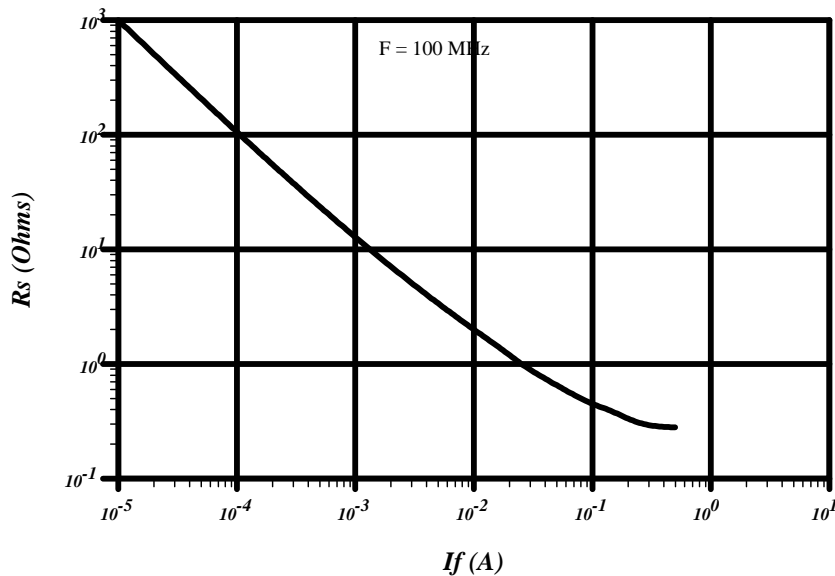
Style "B"

Style "SM"
**UM7500
TYPICAL**

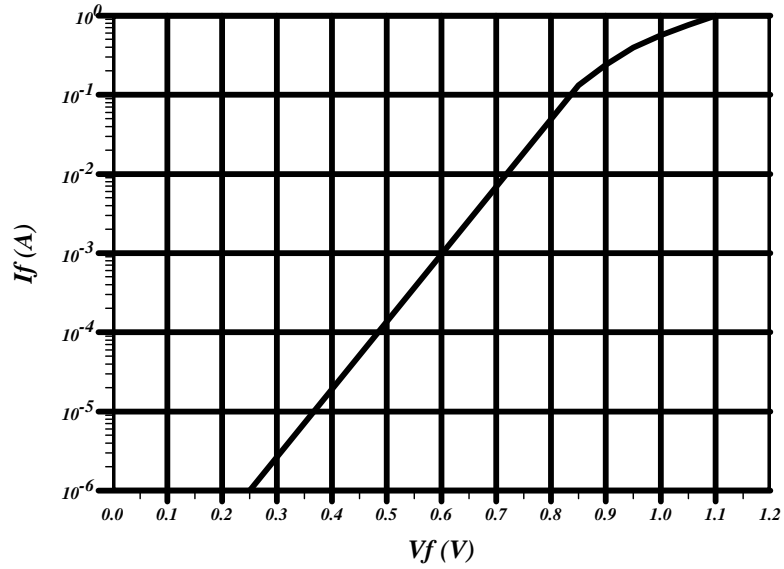
*UM7500
TYPICAL*

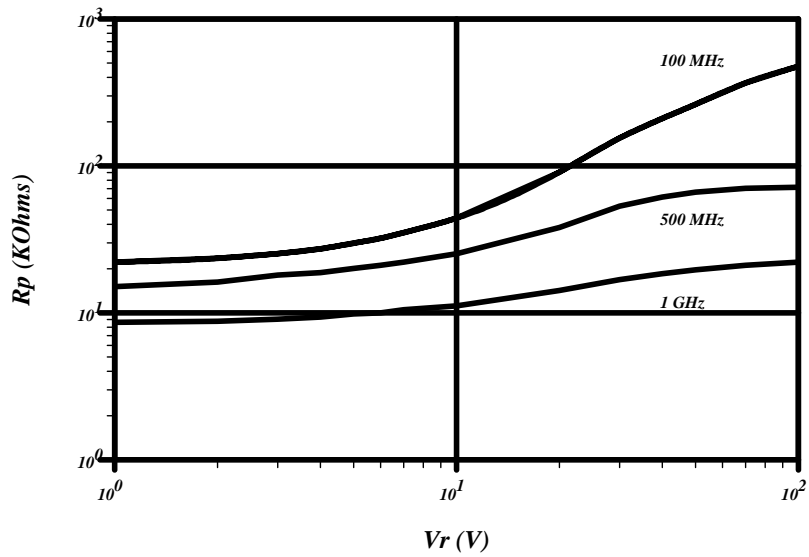

*UM7500
TYPICAL*



UM7500
TYPICAL

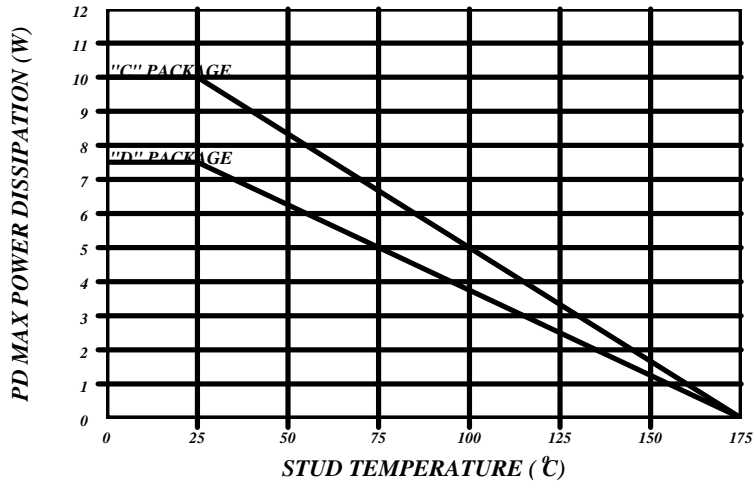

UM7500
TYPICAL

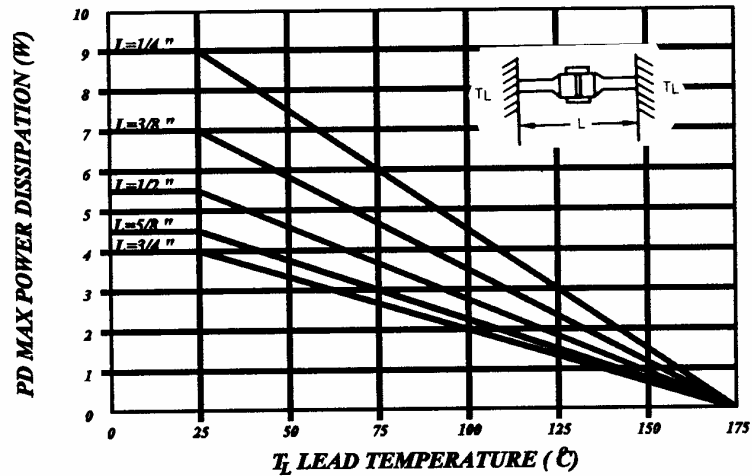

UM7500
TYPICAL

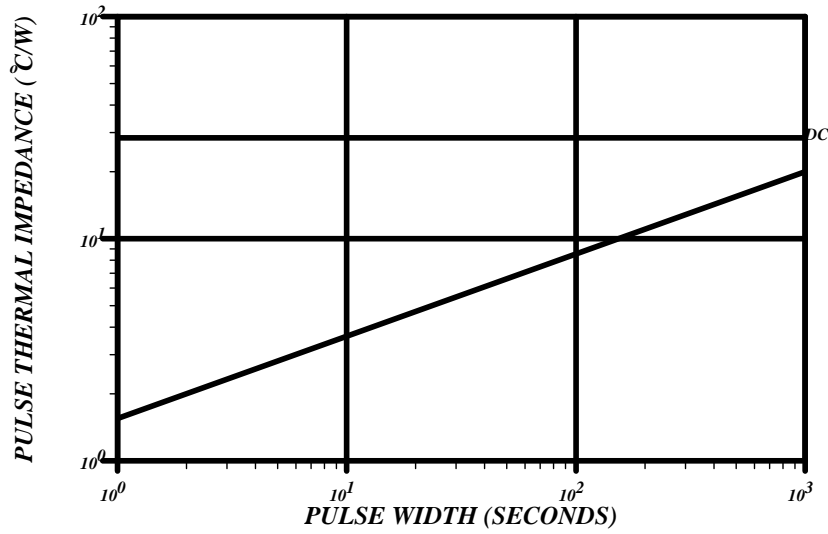

UM7500
TYPICAL

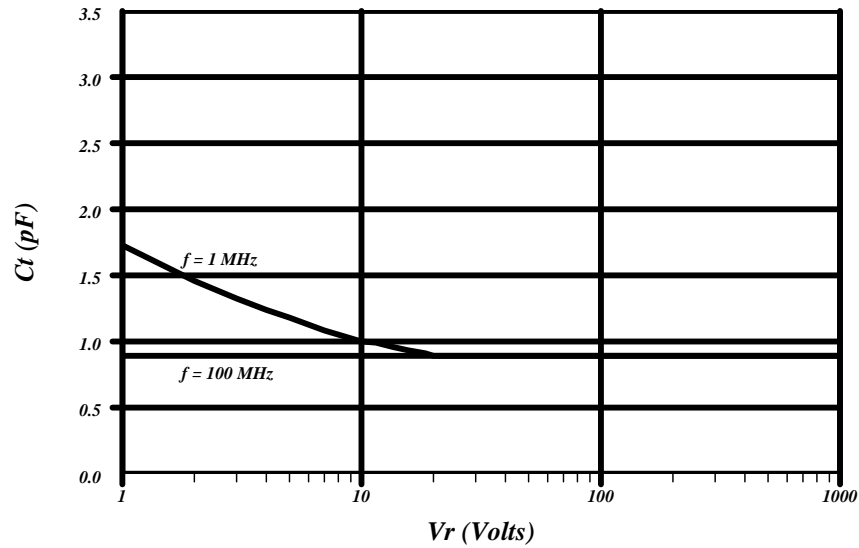

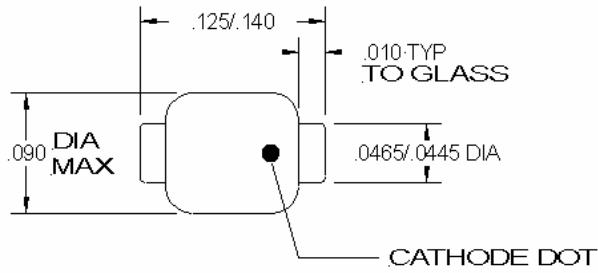
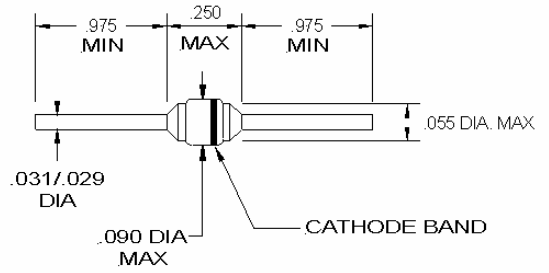
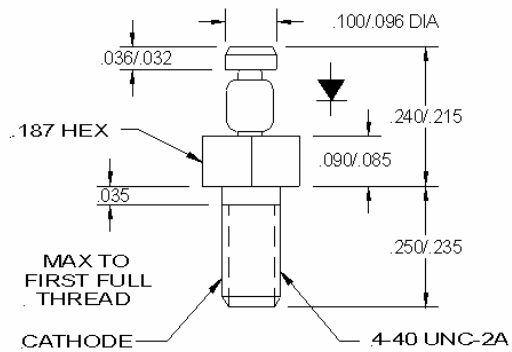
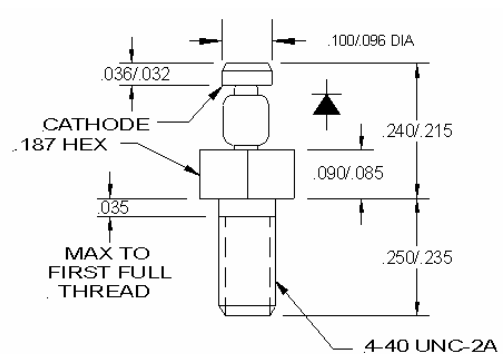
STYLE "A"

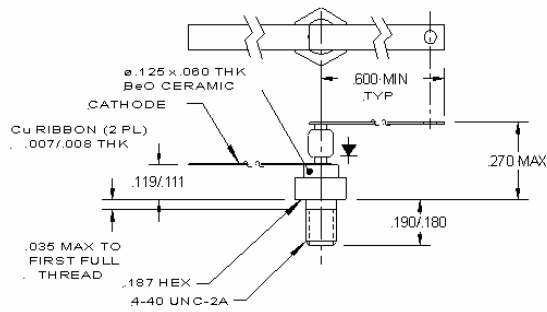
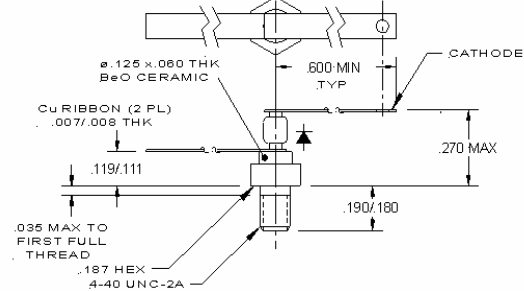
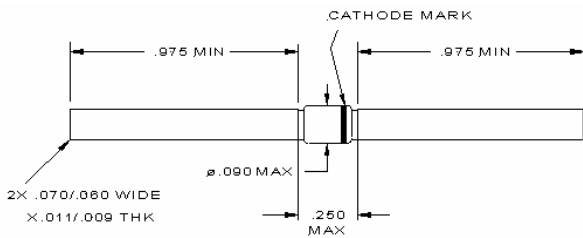
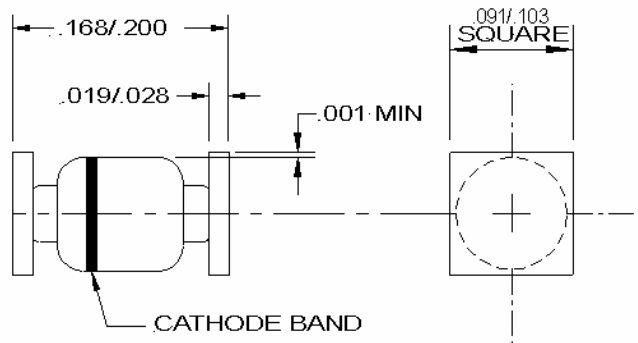
STYLE "B"

STYLE "C"

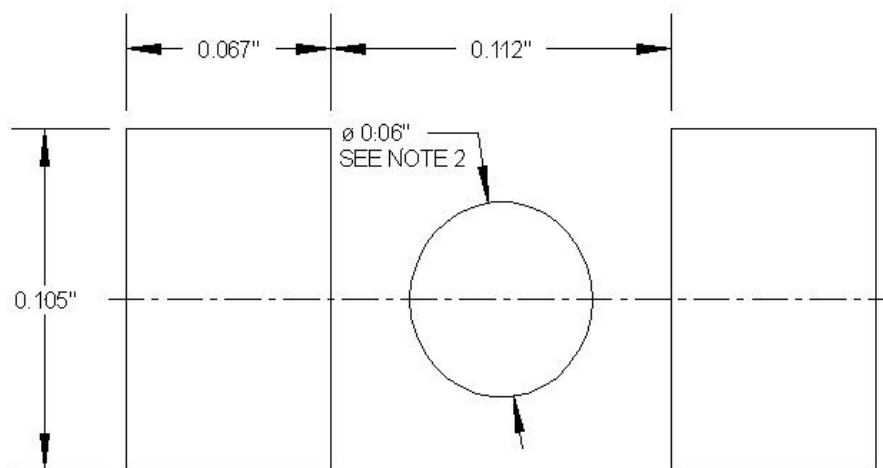
STYLE "CR"

STYLE "D"

STYLE "DR"

STYLE "E"

STYLE "SM"

STYLE "SM" FOOTPRINT

A SIZE
(STANDARD SMALL
SQUARE END CAP OUTLINE)

NOTES:

1. These dimensions will match the terminals and provide for additional solder fillets at the outboard ends at least as wide as the terminals themselves, assuming accuracy of placement within 0.005"
2. If the mounting method chosen requires use of an adhesive separate from the solder compound, a round (or square) spot of cement as shown should be centrally located.



UM7500

POWER PIN DIODES

NOTES: