

M*5283 thru M*5314 and C†5283 thru C†5314

HIGH RELIABILITY CURRENT REGULATOR DIODES

Features

(*) • Available as screened equivalents using prefixes noted below:

- MX as JTX equivalent
- MV as JTXV equivalent
- MS as JANS equivalent

(†) • Available in chip form using prefixes noted below:

- CH as Aluminum on top, gold on back
- CNS as Titanium Nickel Silver on top and bottom

- Provides essentially constant current over a wide voltage range.
- High Source Impedance

Maximum Ratings

Operating Temperature: -55° C to +175° C

Storage Temperature: -55° C to +175° C

DC Power Dissipation: 475 mW @ $T_L \leq 75^\circ\text{C}$

Power Derating: 3.1 mW/° C @ $T_L > 75^\circ\text{C}$

Peak Operating Voltage: 100 Volts

Electrical Characteristics @ 25° C unless otherwise specified.

TYPE NUMBER	REGULATOR CURRENT I_p (mA) @ $V_S = 25V$			MINIMUM DYNAMIC IMPEDANCE @ $V_S = 25V$ Z_S (M Ω) (Note 1)	MINIMUM KNEE IMPEDANCE @ $V_K = 6.0V$ Z_K (M Ω) (Note 2)	MAXIMUM LIMITING VOLTAGE @ $I_L = 0.8 I_p$ (min) V_L (VOLTS)
	NOM	MIN	MAX			
1N5283	0.22	0.198	0.242	25.0	2.75	1.00
1N5284	0.24	0.216	0.264	19.0	2.35	1.00
1N5285	0.27	0.243	0.297	14.0	1.95	1.00
1N5286	0.30	0.270	0.330	09.0	1.60	1.00
1N5287	0.33	0.297	0.363	06.6	1.35	1.00
1N5288	0.39	0.351	0.429	4.10	1.00	1.05
1N5289	0.43	0.387	0.473	3.30	0.870	1.05
1N5290	0.47	0.423	0.517	2.70	0.750	1.05
1N5291	0.56	0.504	0.616	1.90	0.560	1.10
1N5292	0.62	0.558	0.682	1.55	0.470	1.13
1N5293	0.68	0.612	0.748	1.35	0.400	1.15
1N5294	0.75	0.675	0.825	1.15	0.335	1.20
1N5295	0.82	0.738	0.902	1.00	0.290	1.25
1N5296	0.91	0.819	1.001	0.880	0.240	1.29
1N5297	1.00	0.900	1.100	0.800	0.205	1.35
1N5298	1.10	0.990	1.210	0.700	0.180	1.40
1N5299	1.20	1.06	1.32	0.640	0.155	1.45
1N5300	1.30	1.17	1.43	0.580	0.135	1.50
1N5301	1.40	1.26	1.54	0.540	0.115	1.55
1N5302	1.50	1.35	1.65	0.510	0.105	1.60
1N5303	1.60	1.44	1.76	0.475	0.092	1.65
1N5304	1.80	1.62	1.98	0.420	0.074	1.75
1N5305	2.00	1.80	2.20	0.395	0.061	1.85
1N5306	2.20	1.98	2.42	0.370	0.052	1.95
1N5307	2.40	2.16	2.64	0.345	0.044	2.00
1N5308	2.70	2.43	2.97	0.320	0.035	2.15
1N5309	3.00	2.70	3.30	0.300	0.029	2.25
1N5310	3.30	2.97	3.63	0.280	0.024	2.35
1N5311	3.60	3.24	3.96	0.265	0.020	2.50
1N5312	3.90	3.51	4.29	0.255	0.017	2.60
1N5313	4.30	3.87	4.73	0.245	0.014	2.75
1N5314	4.70	4.23	5.17	0.235	0.012	2.90

NOTE 1: Z_S is derived by superimposing a 90Hz rms signal equal to 10% of V_S on V_S .

NOTE 2: Z_K is derived by superimposing a 90Hz rms signal equal to 10% of V_K on V_K .

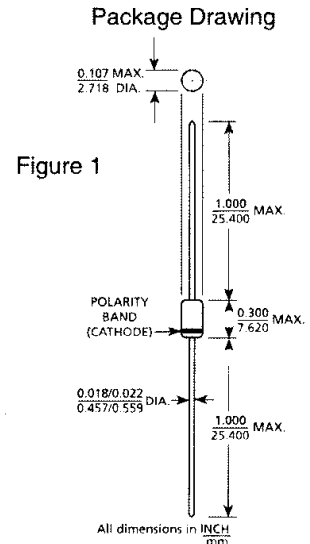

Mechanical Characteristics

CASE: Hermetically sealed glass case. DO-7 outline.

LEAD MATERIAL: Dumet.

LEAD FINISH: Tin plate.

THERMAL RESISTANCE: 300° C/W (Typical) junction to ambient.

POLARITY: Cathode end is banded.

WEIGHT: 0.2 grams

MOUNTING POSITION: Any.

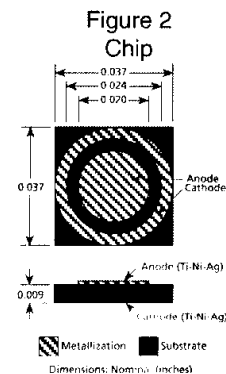

M*5283 thru M*5314 and C†5283 thru C†5314

FIGURE 3
Typical Current Regulator Characteristics

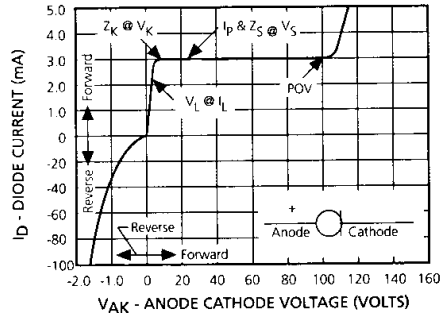

FIGURE 4 Typical Forward Characteristics

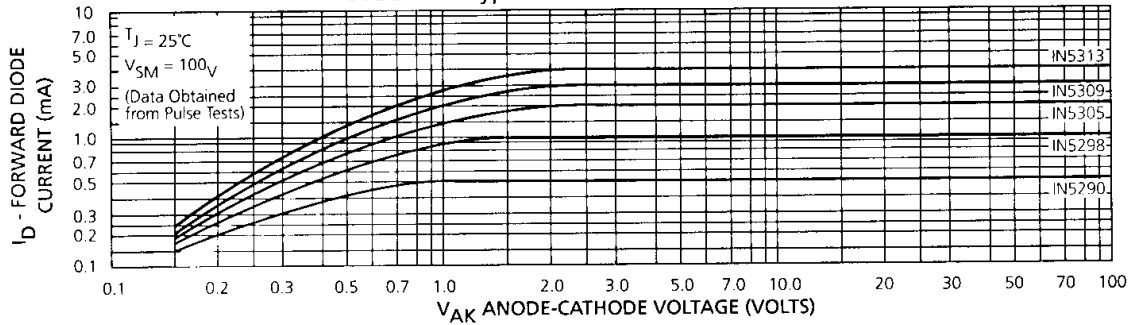

FIGURE 5 Temperature Coefficient

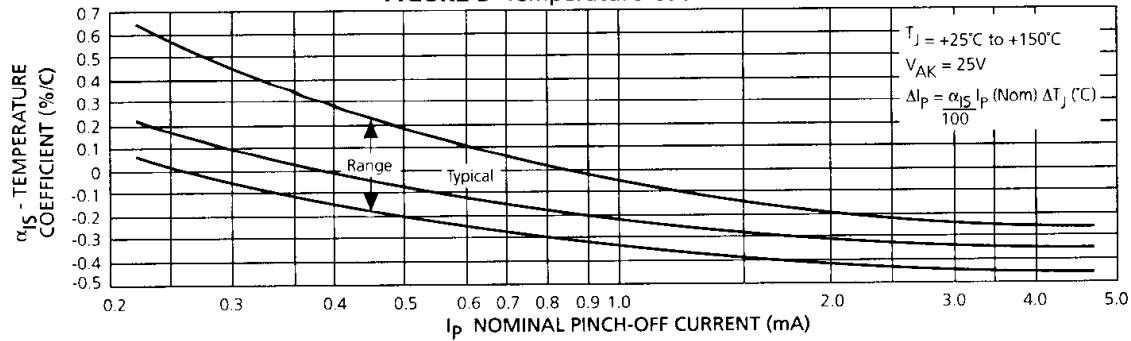
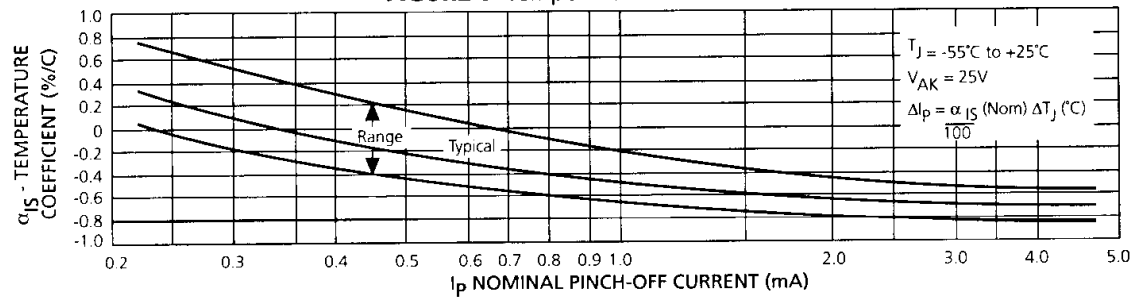

FIGURE 6 Temperature Coefficient



SYMBOLS AND DEFINITIONS

- I_D - Diode Current
- I_P - Pinch-off Current: Regulator current at specified Test Voltage, V_S . I_P is sometimes also identified as I_S .
- POV - Peak Operating Voltage: Maximum voltage to be applied to device.
- α_{I_S} - Current Temperature Coefficient.
- V_K - Knee Impedance Test Voltage: Specified voltage used to establish Knee Impedance, Z_K .
- V_L - Limiting voltage: Measured at I_L , V_L , together with Knee ac Impedance, Z_K , indicates the Knee characteristics of the device.
- V_S - Test Voltage: Voltage at which I_P and Z_S are specified.
- Z_K - Knee AC Impedance at Test Voltage: To test for Z_K , a 90 Hz signal v_K with rms value equal to 10% of test voltage V_K is superimposed on V_K : $Z_K = v_K / i_K$ where i_K is the resultant ac current due to v_K . To provide the most constant current from the diode, Z_K should be as high as possible; therefore, a minimum value of Z_K is specified.
- Z_S - AC Impedance at Test Voltage: Specified as a minimum value. To test for Z_S , a 90 Hz signal v_S with rms value equal to 10% of test voltage, V_S , is superimposed on V_S : $Z_S = v_S / i_S$ where i_S is the resultant ac current due to v_S .