



## 28-BIT 1:2 REGISTERED BUFFER WITH PARITY

**IDT74SSTU32865**

### FEATURES:

- 1.8V Operation
- SSTL\_18 style clock and data inputs
- Differential CLK input
- Control inputs compatible with LVCMOS levels
- Flow-through architecture for optimum PCB design
- Latch-up performance exceeds 100mA
- ESD >2000V per MIL-STD-883, Method 3015; >200V using machine model (C = 200pF, R = 0)
- Available in 160-pin CTBGA package

### APPLICATIONS:

- Along with CSPU877/A/D DDR2 PLL, provides complete solution for DDR2 DIMMs
- Optimized for DDR2-400/533 (PC2-3200/4300) JEDEC Raw Card D

### DESCRIPTION:

The SSTU32865 is a 28-bit 1:2 configurable registered buffer designed for 1.7V to 1.9V  $V_{DD}$  operation. All clock and data inputs are compatible with the JEDEC standard for SSTL\_18. The control inputs are LVCMOS. All outputs are 1.8V CMOS drivers that have been optimized to drive the DDR2 DIMM load.

The SSTU32865 operates from a differential clock (CLK and  $\overline{CLK}$ ). Data are registered at the crossing of CLK going high and  $\overline{CLK}$  going low.

This device supports low-power standby operation. When the reset input ( $\overline{RESET}$ ) is low, the differential input receivers are disabled, and undriven (floating) data, clock, and reference voltage ( $V_{REF}$ ) inputs are allowed. In addition, when  $\overline{RESET}$  is low all registers are reset, and all outputs are forced low. The LVCMOS  $\overline{RESET}$  and Cx inputs must always be held at a valid logic high or low level.

To ensure defined outputs from the register before a stable clock has been supplied,  $\overline{RESET}$  must be held in the low state during power up.

In the DDR2 DIMM application,  $\overline{RESET}$  is specified to be completely asynchronous with respect to CLK and  $\overline{CLK}$ . Therefore, no timing relationship can be guaranteed between the two. When entering reset, the register will be cleared and the outputs will be driven low quickly, relative to the time to disable the differential input receivers. However, when coming out of a reset, the register will become active quickly, relative to the time to enable the differential input receivers. As long as the data inputs are low, and the clock is stable during the time from the low-to-high transition of  $\overline{RESET}$  until the input receivers are fully enabled, the design of the SSTU32865 must ensure that the outputs will remain low, thus ensuring no glitches on the outputs.

The device monitors both  $\overline{DCS0}$  and  $\overline{DCS1}$  inputs and will gate the Qn outputs from changing states when both  $\overline{DCS0}$  and  $\overline{DCS1}$  are high. If either  $\overline{DCS0}$  and  $\overline{DCS1}$  input is low, the Qn outputs will function normally. The  $\overline{RESET}$  input has priority over the  $\overline{DCS0}$  and  $\overline{DCS1}$  control and will force the Qn outputs low and the  $\overline{PYTERR}$  output high. If the DCS-control functionality is not desired, then the CSGateEnable input can be hard-wired to ground, in which case the set-up time requirement for DCS would be the same as for the other D data inputs.

The SSTU32865 includes a parity checking function. The SSTU32865 accepts a parity bit from the memory controller at its input pin PARIN, compares it with the data received on the D-inputs, and indicates whether a parity error has occurred on its open-drain  $\overline{PYTERR}$  pin (active low).

FUNCTIONAL BLOCK DIAGRAM (1:2)

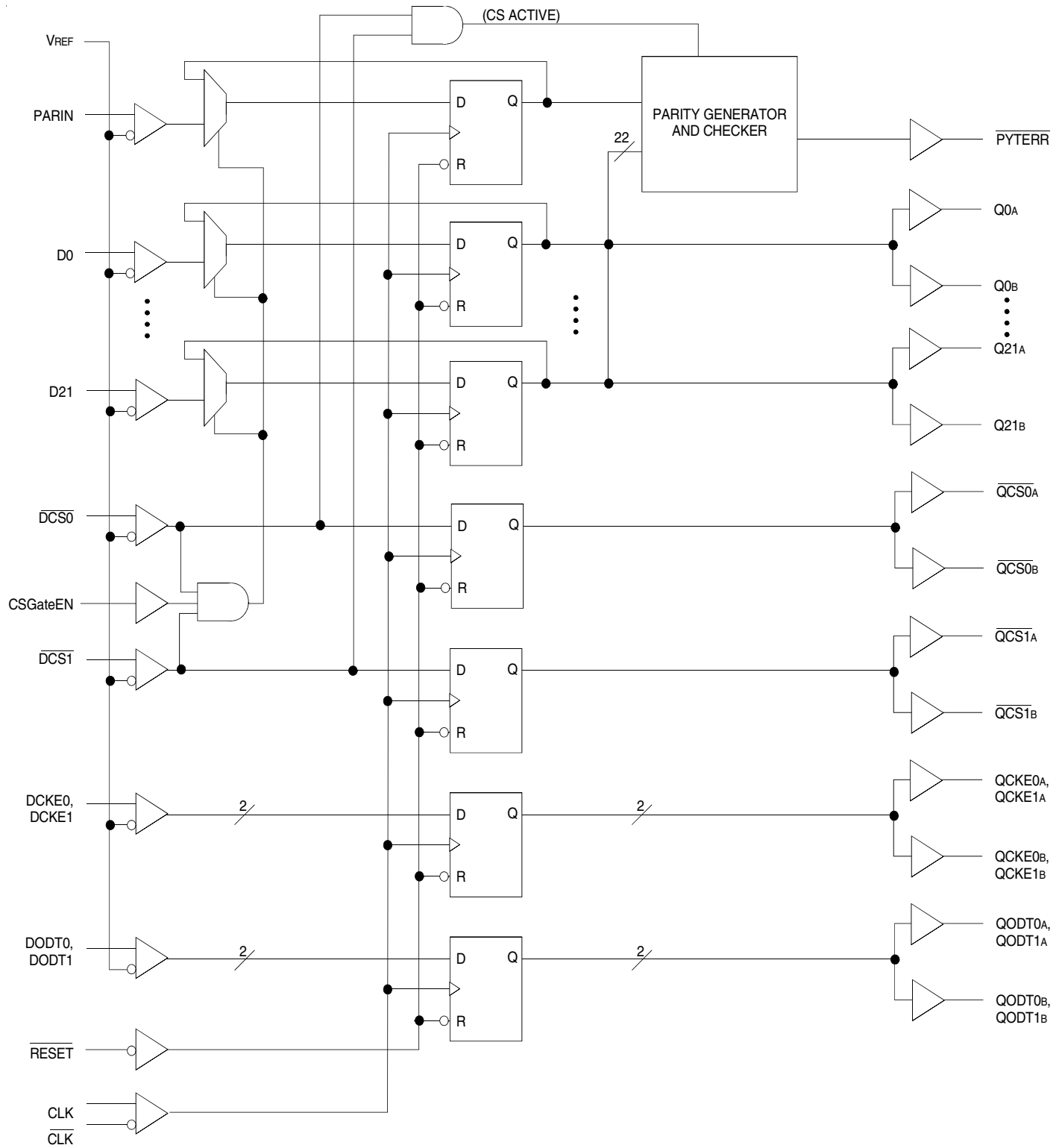

PIN CONFIGURATION

	1	2	3	4	5	6	7	8	9	10	11	12
A	VREF	NC	PARIN	NC	NC	QCKE1A	QCKE0A	Q21A	Q19A	Q18A	Q17B	Q17A
B	D1	D2	NC	NC	NC	QCKE1B	QCKE0B	Q21B	Q19B	Q18B	QODT0B	QODT0A
C	D3	D4									QODT1B	QODT1A
D	D6	D5		VDDL	GND	NC	NC	GND	GND		Q20B	Q20A
E	D7	D8		VDDL	GND	VDDL	VDDR	GND	GND		Q16B	Q16A
F	D11	D9		VDDL	GND			VDDR	VDDR		Q1B	Q1A
G	D18	D12		VDDL	GND			VDDR	VDDR		Q2B	Q2A
H	CSGate EN	D15		VDDL	GND			GND	GND		Q5B	Q5A
J	CLK	$\overline{\text{DCS0}}$		GND	GND			VDDR	VDDR		$\overline{\text{QCS0B}}$	$\overline{\text{QCS0A}}$
K	$\overline{\text{CLK}}$	$\overline{\text{DCS1}}$		VDDL	VDDL			GND	GND		$\overline{\text{QCS1B}}$	$\overline{\text{QCS1A}}$
L	$\overline{\text{RESET}}$	D14		GND	GND			VDDR	VDDR		Q6B	Q6A
M	D0	D10		GND	GND			GND	GND		Q10B	Q10A
N	D17	D16		VDDL	VDDL			VDDR	VDDR		Q9B	Q9A
P	D19	D21		GND	VDDL	VDDL	VDDR	VDDR	GND		Q11B	Q11A
R	D13	D20		GND	VDDL	VDDL	GND	GND	GND		Q15B	Q15A
T	DODT1	DODT0									Q14B	Q14A
U	DCKE0	DCKE1	MCL	$\overline{\text{PYTERR}}$	MCH	Q3B	Q12B	Q7B	Q4B	Q13B	Q0B	Q8B
V	VREF	MCL	MCL	NC	MCH	Q3A	Q12A	Q7A	Q4A	Q13A	Q0A	Q8A

MCL denotes a pin that Must be Connected LOW. MCH denotes a pin that Must be Connected HIGH.

160-BALL CTBGA  
TOP VIEW

# 160 BALL CTBGA PACKAGE ATTRIBUTES

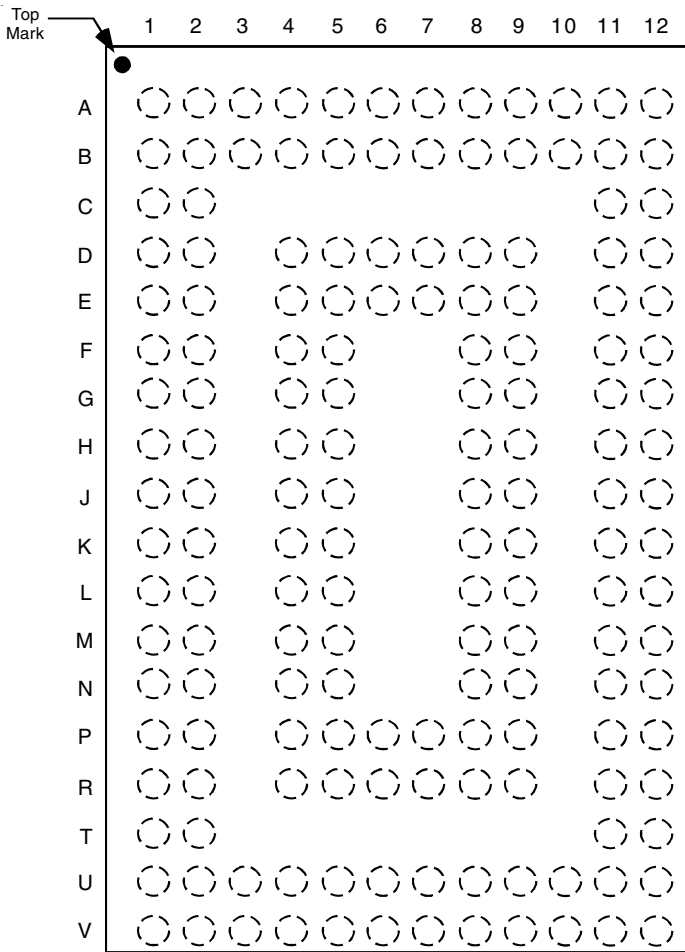

TOP VIEW

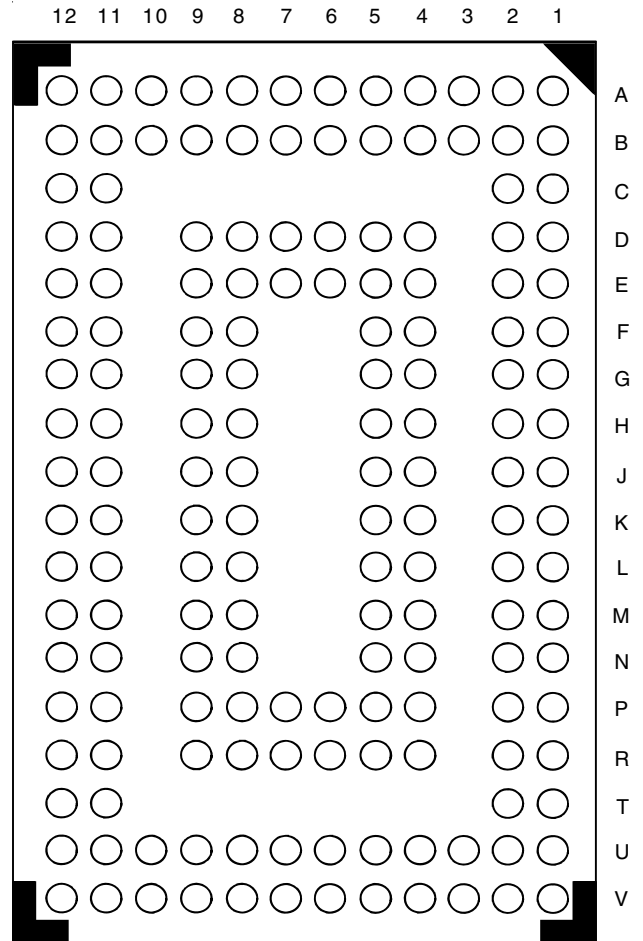

BOTTOM VIEW

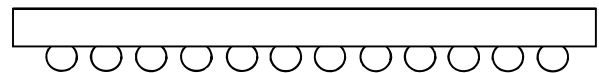

SIDE VIEW

FUNCTION TABLE (EACH FLIP-FLOP) (1)

Inputs							Outputs		
RESET	DCS0	DCS1	CSGate Enable	CLK	CLK	Dn, DODTn, DCKEn	Qn	QCS	QODT, QCKE
H	L	L	X	↑	↓	L	L	L	L
H	L	L	X	↑	↓	H	H	L	H
H	L	L	X	L or H	L or H	X	Q <sub>0</sub> <sup>(2)</sup>	Q <sub>0</sub> <sup>(2)</sup>	Q <sub>0</sub> <sup>(2)</sup>
H	L	H	X	↑	↓	L	L	L	L
H	L	H	X	↑	↓	H	H	L	H
H	L	H	X	L or H	L or H	X	Q <sub>0</sub> <sup>(2)</sup>	Q <sub>0</sub> <sup>(2)</sup>	Q <sub>0</sub> <sup>(2)</sup>
H	H	L	X	↑	↓	L	L	H	L
H	H	L	X	↑	↓	H	H	H	H
H	H	L	X	L or H	L or H	X	Q <sub>0</sub> <sup>(2)</sup>	Q <sub>0</sub> <sup>(2)</sup>	Q <sub>0</sub> <sup>(2)</sup>
H	H	H	L	↑	↓	L	L	H	L
H	H	H	L	↑	↓	H	H	H	H
H	H	H	L	L or H	L or H	X	Q <sub>0</sub> <sup>(2)</sup>	Q <sub>0</sub> <sup>(2)</sup>	Q <sub>0</sub> <sup>(2)</sup>
H	H	H	H	↑	↓	L	Q <sub>0</sub> <sup>(2)</sup>	H	L
H	H	H	H	↑	↓	H	Q <sub>0</sub> <sup>(2)</sup>	H	H
H	H	H	H	L or H	L or H	X	Q <sub>0</sub> <sup>(2)</sup>	Q <sub>0</sub> <sup>(2)</sup>	Q <sub>0</sub> <sup>(2)</sup>
L	X or Floating	X or Floating	X or Floating	X or Floating	X or Floating	X or Floating	L	L	L

NOTES:

1. H = HIGH Voltage Level  
L = LOW Voltage Level  
X = Don't Care  
↑ = LOW to HIGH  
↓ = HIGH to LOW
2. Output level before the indicated steady-state conditions were established.

PARITY AND STANDBY FUNCTION TABLE(1)

Inputs							Output
RESET	DCS0	DCS1	CLK	CLK	Σ of Inputs = H (D0 - D21)	PARIN(2)	PYTERR(3)
H	L	H	↑	↓	Even	L	H
H	L	H	↑	↓	Odd	L	L
H	L	H	↑	↓	Even	H	L
H	L	H	↑	↓	Odd	H	H
H	H	L	↑	↓	Even	L	H
H	H	L	↑	↓	Odd	L	L
H	H	L	↑	↓	Even	H	L
H	H	L	↑	↓	Odd	H	H
H	H	H	↑	↓	X	X	PYTERR <sub>0</sub> (4)
H	X	X	L or H	L or H	X	X	PYTERR <sub>0</sub> (4)
L	X or Floating	X or Floating	X or Floating	X or Floating	X or Floating	X or Floating	H

NOTES:

- H = HIGH Voltage Level  
L = LOW Voltage Level  
X = Don't Care  
↑ = LOW to HIGH  
↓ = HIGH to LOW
- PARIN arrives one clock cycle after the data to which it applies
- This transition assumes PYTERR is HIGH at the crossing of CLK going HIGH and CLK going LOW. If PYTERR is LOW, it stays latched LOW for two clock cycles, or until RESET is driven LOW.
- Output level before the indicated steady-state conditions were established.

## REGISTER TIMING

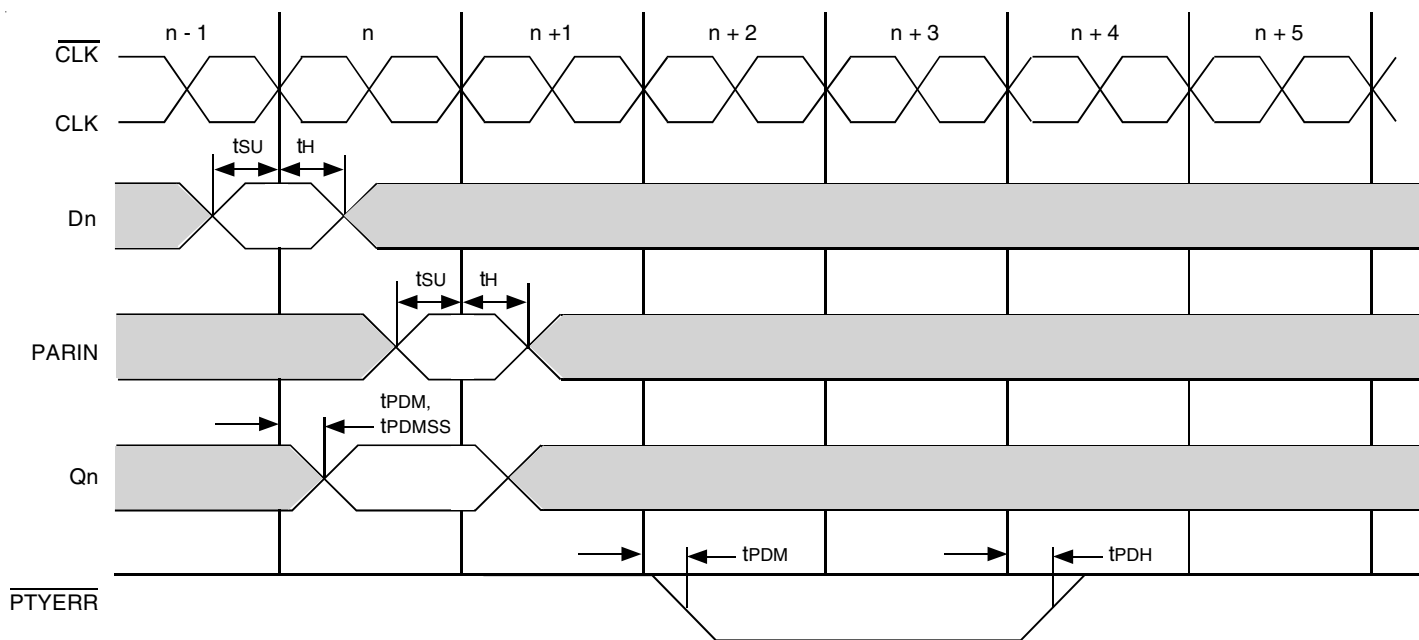

## PARITY LOGIC DIAGRAM

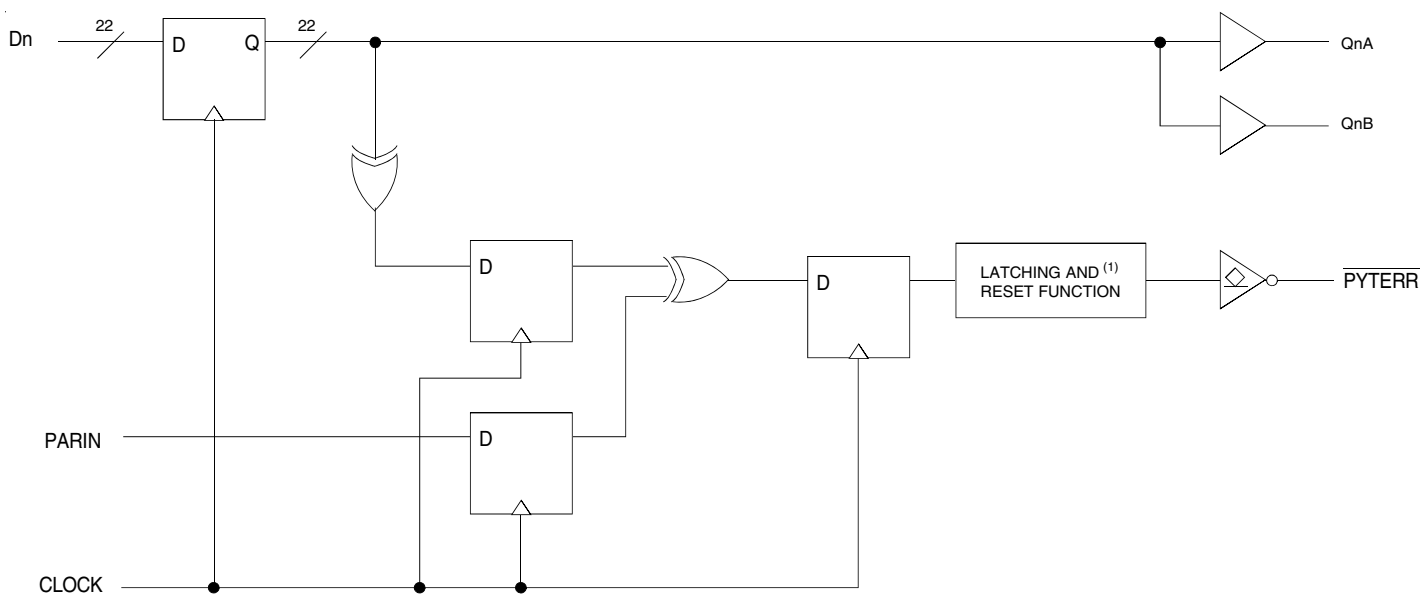

**NOTE:**

1. This function holds the error for two cycles. See REGISTER TIMING diagram.

## ABSOLUTE MAXIMUM RATINGS (1)

Symbol	Description	Max.	Unit
V <sub>DD</sub>	Supply Voltage Range	-0.5 to 2.5	V
V <sub>I</sub> <sup>(2,3)</sup>	Input Voltage Range	-0.5 to 2.5	V
V <sub>O</sub> <sup>(2,3)</sup>	Output Voltage Range	-0.5 to V <sub>DD</sub> + 0.5	V
I <sub>IK</sub>	Input Clamp Current	±50	mA
	V <sub>I</sub> < 0 V <sub>I</sub> > V <sub>DD</sub>		
I <sub>OK</sub>	Output Clamp Current	±50	mA
	V <sub>O</sub> < 0 V <sub>O</sub> > V <sub>DD</sub>		
I <sub>O</sub>	Continuous Output Current, V <sub>O</sub> = 0 to V <sub>DD</sub>	±50	mA
V <sub>DD</sub>	Continuous Current through each V <sub>DD</sub> or GND	±100	mA
T <sub>STG</sub>	Storage Temperature Range	-65 to +150	°C

### NOTES:

- Stresses greater than those listed under ABSOLUTE MAXIMUM RATINGS may cause permanent damage to the device. This is a stress rating only and functional operation of the device at these or any other conditions above those indicated in the operational sections of this specification is not implied. Exposure to absolute maximum rating conditions for extended periods may affect reliability.
- The input and output negative voltage ratings may be exceeded if the ratings of the I/P and O/P clamp current are observed.
- This value is limited to 2.5V maximum.

## TIMING REQUIREMENTS OVER RECOMMENDED OPERATING FREE-AIR TEMPERATURE RANGE

Symbol	Parameter	V <sub>DD</sub> = 1.8V ± 0.1V		Unit	
		Min.	Max.		
f <sub>CLOCK</sub>	Clock Frequency	—	270	MHz	
t <sub>w</sub>	Pulse Duration, CLK, $\overline{\text{CLK}}$ HIGH or LOW	1	—	ns	
t <sub>ACT</sub> <sup>(1,2)</sup>	Differential Inputs Active Time	—	10	ns	
t <sub>INACT</sub> <sup>(1,3)</sup>	Differential Inputs Inactive Time	—	15	ns	
t <sub>SU</sub>	Setup Time	$\overline{\text{DCS}}\overline{\text{n}}$ before CLK $\uparrow$ , $\overline{\text{CLK}}\downarrow$	0.7	—	ns
		Data, PARIN, DODT, and DCKE before CLK $\uparrow$ , $\overline{\text{CLK}}\downarrow$	0.5	—	
t <sub>H</sub>	Hold Time	Data, $\overline{\text{DCS}}\overline{\text{n}}$ , PARIN, DCKE, and DODT after CLK $\uparrow$ , $\overline{\text{CLK}}\downarrow$	0.5	—	ns

### NOTES:

- This parameter is not production tested.
- Data and V<sub>REF</sub> inputs must be low a minimum time of t<sub>ACT</sub> max, after  $\overline{\text{RESET}}$  is taken HIGH.
- Data, V<sub>REF</sub>, and clock inputs must be held at valid levels (not floating) a minimum time of t<sub>INACT</sub> max, after  $\overline{\text{RESET}}$  is taken LOW.



## TERMINAL FUNCTIONS

Signal Group	Terminal Name	Type	Description
Ungated Inputs	DCKE0, DCKE1 DODT0, DODT1	SSTL_18	DRAM function pins not associated with Chip Select
Chip Select Gated Inputs	D0:D21	SSTL_18	DRAM inputs, re-driven only when Chip Select is LOW
Chip Select Inputs	$\overline{DCS0}$ , $\overline{DCS1}$	SSTL_18	DRAM Chip Select signals. These pins initiate DRAM address/command decodes, and as such at least one will be LOW when a valid address/command is present. The register can be programmed to re-drive all D-inputs only (CSGateEN HIGH) when at least one Chip Select input is LOW.
Re-Driven Outputs	Q0A:Q21A Q0B:Q21B $\overline{QCS0}$ -1A, B QCKE0-1A, B QODT0-1A, B	SSTL_18	Outputs of the register, valid after the specified clock count and immediately following a rising edge of the clock
Parity Input	PARIN	SSTL_18	Input parity is received on pin PARIN, and should maintain odd parity across the D0:D21 inputs, at the rising edge of the clock
Parity Error Output	$\overline{PTYERR}$	Open Drain	When LOW, this output indicates that a parity error was identified associated with the address and/or command inputs. $\overline{PTYERR}$ will be active for two clock cycles, and delayed by an additional clock cycle for compatibility with final parity out timing on the industry-standard DDR-II register with parity (in JEDEC definition).
Program Inputs	CSGateEN	1.8V LVCMOS	Chip Select Gate Enable. When HIGH, the D0:D21 inputs will be latched only when at least one Chip Select input is LOW during the rising edge of the clock. When LOW, the D0:D21 inputs will be latched and re-driven on every rising edge of the clock.
Clock Inputs	CLK, $\overline{CLK}$	SSTL_18	Differential master clock input pair to the register. The register operation is triggered by a rising edge on the positive clock input (CLK).
Miscellaneous Inputs	MCL, MCH		Must be connected to a Logic LOW or HIGH.
	$\overline{RESET}$	1.8V LVCMOS	Asynchronous Reset Input. When LOW, it causes a reset of the internal latches, thereby forcing the outputs LOW. $\overline{RESET}$ also resets the $\overline{PTYERR}$ signal.
	VREF	0.9V nominal	Input reference voltage for SSTL_18 inputs. Two pins (internally tied together) are used for increased reliability.

OPERATING CHARACTERISTICS,  $T_A = 25^\circ\text{C}$  (1,2)

Symbol	Parameter	Min.	Typ.	Max.	Unit	
V <sub>DD</sub>	Supply Voltage	1.7	—	1.9	V	
V <sub>REF</sub>	Reference Voltage	0.49 * V <sub>DD</sub>	0.5 * V <sub>DD</sub>	0.51 * V <sub>DD</sub>	V	
V <sub>TT</sub>	Termination Voltage	V <sub>REF</sub> - 40mV	V <sub>REF</sub>	V <sub>REF</sub> + 40mV	V	
V <sub>I</sub>	Input Voltage	0	—	V <sub>DD</sub>	V	
V <sub>IH</sub>	AC High-Level Input Voltage	Data Inputs	V <sub>REF</sub> + 250mV	—	V	
V <sub>IL</sub>	AC Low-Level Input Voltage	Data Inputs	—	V <sub>REF</sub> - 250mV	V	
V <sub>IH</sub>	DC High-Level Input Voltage	Data Inputs	V <sub>REF</sub> + 125mV	—	V	
V <sub>IL</sub>	DC Low-Level Input Voltage	Data Inputs	—	V <sub>REF</sub> - 125mV	V	
V <sub>IH</sub>	High-Level Input Voltage	$\overline{\text{RESET}}$ , Cx	0.65 * V <sub>DD</sub>	—	V	
V <sub>IL</sub>	Low-Level Input Voltage	$\overline{\text{RESET}}$ , Cx	—	0.35 * V <sub>DD</sub>	V	
V <sub>ICR</sub>	Common Mode Input Voltage	CLK, $\overline{\text{CLK}}$	0.675	—	1.125	V
V <sub>ID</sub>	Differential Input Voltage	CLK, $\overline{\text{CLK}}$	600	—	—	mV
I <sub>OH</sub>	High-Level Output Current	—	—	-8	mA	
I <sub>OL</sub>	Low-Level Output Current	—	—	8	mA	
T <sub>A</sub>	Operating Free-Air Temperature	0	—	70	°C	

NOTES:

1. The  $\overline{\text{RESET}}$  and Cx inputs of the device must be held at valid levels (not floating) to ensure proper device operation.
2. The differential inputs must not be floating unless  $\overline{\text{RESET}}$  is LOW.

DC ELECTRICAL CHARACTERISTICS OVER OPERATING RANGE

Following Conditions Apply Unless Otherwise Specified:

Operating Condition:  $T_A = 0^\circ\text{C}$  to  $+70^\circ\text{C}$ ,  $V_{DD} = 1.8\text{V} \pm 0.1\text{V}$

Symbol	Parameter	Test Conditions	Min.	Typ.	Max.	Unit
V <sub>OH</sub>		V <sub>DD</sub> = 1.7V to 1.9V, I <sub>OH</sub> = - 6 mA	1.2	—	—	V
V <sub>OL</sub>		V <sub>DD</sub> = 1.7V to 1.9V, I <sub>OL</sub> = 6 mA	—	—	0.5	V
I <sub>I</sub>	All Inputs	V <sub>I</sub> = V <sub>DD</sub> or GND	—	—	±5	μA
I <sub>DD</sub>	Static Standby	I <sub>O</sub> = 0, V <sub>DD</sub> = 1.9V, $\overline{\text{RESET}}$ = GND	—	—	200	μA
	Static Operating	I <sub>O</sub> = 0, V <sub>DD</sub> = 1.9V, $\overline{\text{RESET}}$ = V <sub>DD</sub> , V <sub>I</sub> = V <sub>IH</sub> (AC) or V <sub>IL</sub> (AC)	—	—	40	mA
I <sub>DD</sub>	Dynamic Operating (Clock Only)	I <sub>O</sub> = 0, V <sub>DD</sub> = 1.8V, $\overline{\text{RESET}}$ = V <sub>DD</sub> , V <sub>I</sub> = V <sub>IH</sub> (AC) or V <sub>IL</sub> (AC), CLK and $\overline{\text{CLK}}$ Switching 50% Duty Cycle.	—	—	—	μA/Clock MHz
	Dynamic Operating (Per Each Data Input)	I <sub>O</sub> = 0, V <sub>DD</sub> = 1.8V, $\overline{\text{RESET}}$ = V <sub>DD</sub> , V <sub>I</sub> = V <sub>IH</sub> (AC) or V <sub>IL</sub> (AC), CLK and $\overline{\text{CLK}}$ Switching at 50% Duty Cycle. One Data Input Switching at Half Clock Frequency, 50% Duty Cycle.	1:1 Mode	—	—	μA/Clock MHz/Data Input
C <sub>I</sub>	Dn	V <sub>I</sub> = V <sub>REF</sub> ± 250mV, V <sub>DD</sub> = 1.8V	2.5	—	3.5	pF
	$\overline{\text{DCSn}}$ and CS <sub>GateENable</sub>		4	—	6	
	CLK and $\overline{\text{CLK}}$	V <sub>ICR</sub> = 0.9V, V <sub>ID</sub> = 600mV, V <sub>DD</sub> = 1.8V	4	—	6	
	$\overline{\text{RESET}}$	V <sub>I</sub> = V <sub>DD</sub> or GND, V <sub>DD</sub> = 1.8V	2	—	6	

SWITCHING CHARACTERISTICS OVER RECOMMENDED FREE-AIR OPERATING RANGE (UNLESS OTHERWISE NOTED) <sup>(1)</sup>

Symbol	Parameter	V <sub>DD</sub> = 1.8V ± 0.1V		Unit
		Min	Max.	
f <sub>MAX</sub>		270	—	MHz
t <sub>PDM</sub> <sup>(2)</sup>	CLK and $\overline{\text{CLK}}$ to Q	1.41	2.15	ns
t <sub>LH</sub>	LOW to HIGH Delay, CLK and $\overline{\text{CLK}}$ to $\overline{\text{PYTERR}}$	1.2	3	ns
t <sub>HL</sub>	HIGH to LOW Delay, CLK and $\overline{\text{CLK}}$ to $\overline{\text{PYTERR}}$	1	3	ns
t <sub>PLH</sub>	LOW to HIGH Propagation Delay, $\overline{\text{RESET}}$ to $\overline{\text{PYTERR}}$	—	3	ns
t <sub>PDMSS</sub> <sup>(2,3)</sup>	CLK and $\overline{\text{CLK}}$ to Q (simultaneous switching)	—	2.35	ns
t <sub>RPHL</sub>	$\overline{\text{RESET}}$ to Q	—	3	ns
dV/dt <sub>r</sub>	Output slew rate from 20% to 80%	1	4	V/ns
dV/dt <sub>f</sub>	Output slew rate from 20% to 80%	1	4	V/ns
dV/dt <sub>Δ</sub> <sup>(4)</sup>	Output slew rate from 20% to 80%	—	1	V/ns

NOTES:

1. See TEST CIRCUITS AND WAVEFORMS.
2. Includes 350ps of test load transmission line delay.
3. This parameter is not production tested.
4. Difference between dV/dt<sub>r</sub> (rising edge rate) and dV/dt<sub>f</sub> (falling edge rate).

TEST CIRCUITS AND WAVEFORMS ( $V_{DD} = 1.8V \pm 0.1V$ )

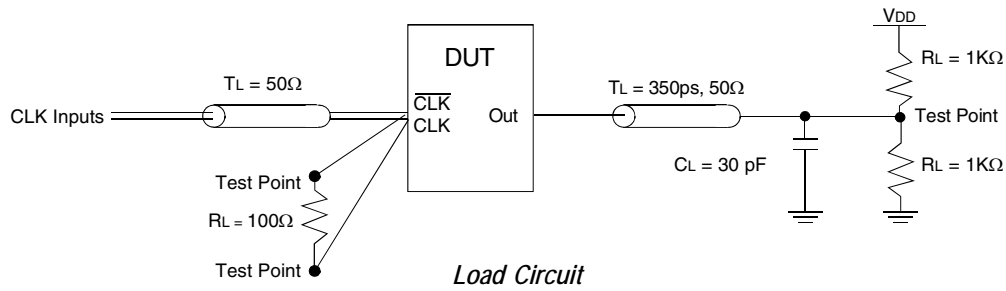

Load Circuit

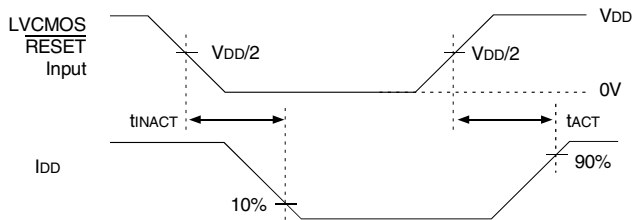

Voltage and Current Waveforms  
Inputs Active and Inactive Times

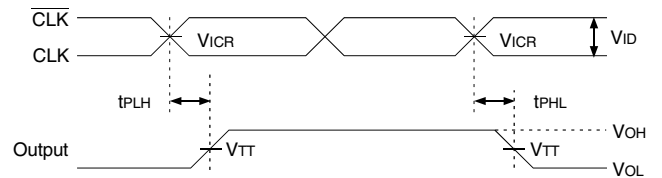

Voltage Waveforms - Propagation Delay Times

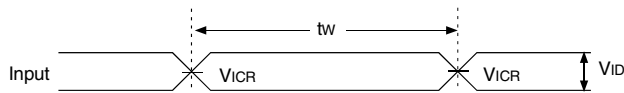

Voltage Waveforms - Pulse Duration

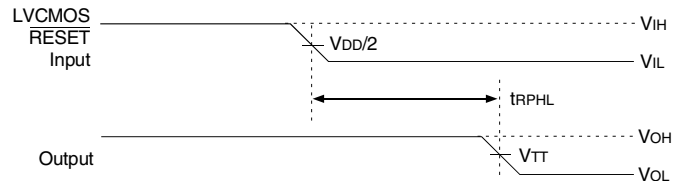

Voltage Waveforms - Propagation Delay Times

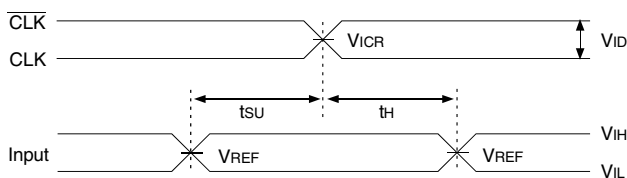

Voltage Waveforms - Setup and Hold Times

NOTES:

1. CL includes probe and jig capacitance.
2. IDD tested with clock and data inputs held at VDD or GND, and Io = 0mA
3. All input pulses are supplied by generators having the following characteristics: PRR ≤ 10MHz, Zo = 50Ω, input slew rate = 1 V/ns ± 20% (unless otherwise specified).
4. The outputs are measured one at a time with one transition per measurement.
5. VTT = VREF = VDD/2
6. VIH = VREF + 250mV (AC voltage levels) for differential inputs. VIH = VDD for LVC MOS input.
7. VIL = VREF - 250mV (AC voltage levels) for differential inputs. VIL = GND for LVC MOS input.
8. Vid = 600mV.
9. tPLH and tPHL are the same as tPDM.

TEST CIRCUITS AND WAVEFORMS ( $V_{DD} = 1.8V \pm 0.1V$ )

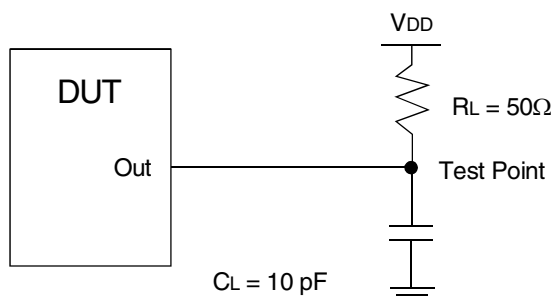

Load Circuit: High-to-Low Slew-Rate

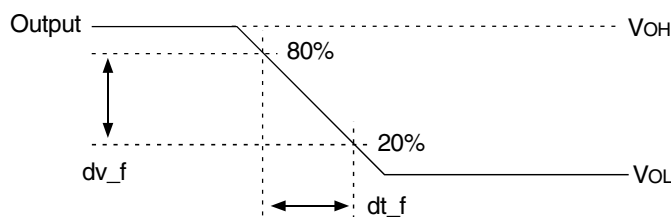

Voltage Waveforms: High-to-Low Slew-Rate

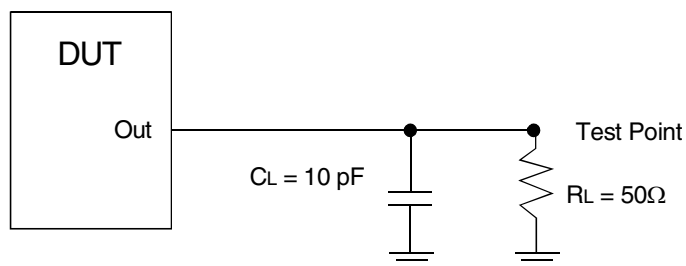

Load Circuit: Low-to-High Slew-Rate

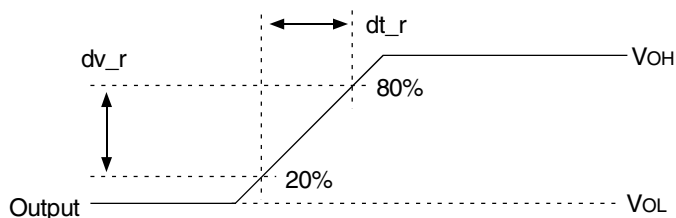

Voltage Waveforms: Low-to-High Slew-Rate

NOTES:

1.  $C_L$  includes probe and jig capacitance.
2. All input pulses are supplied by generators having the following characteristics:  $PRR \leq 10\text{ MHz}$ ,  $Z_o = 50\Omega$ , input slew rate =  $1\text{ V/ns} \pm 20\%$  (unless otherwise specified).

TEST CIRCUITS AND WAVEFORMS ( $V_{DD} = 1.8V \pm 0.1V$ )

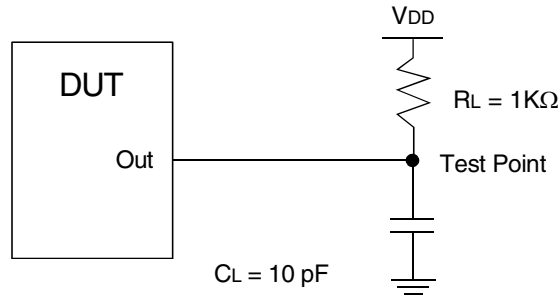

Load Circuit: High-to-Low Slew-Rate

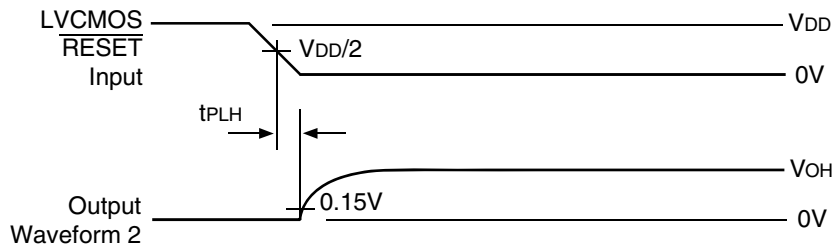

Voltage Waveforms: Open Drain Output Low-to-High Transition Time (with Respect to **RESET** Input)

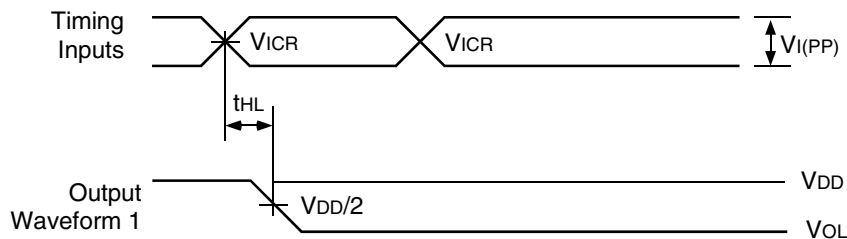

Voltage Waveforms: Open Drain Output High-to-Low Transition Time (with Respect to Clock Inputs)

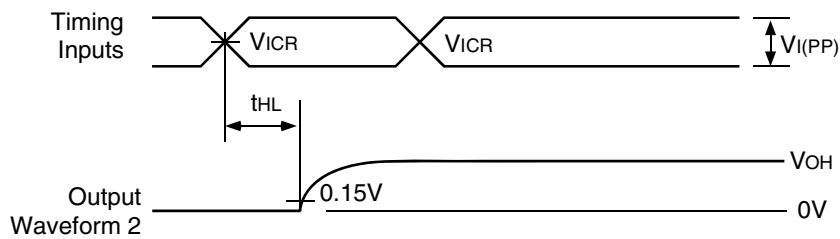

Voltage Waveforms: Open Drain Output Low-to-High Transition Time (with Respect to Clock Inputs)

NOTES:

1.  $C_L$  includes probe and jig capacitance.
2. All input pulses are supplied by generators having the following characteristics:  $PRR \leq 10MHz$ ,  $Z_o = 50\Omega$ , input slew rate =  $1 V/ns \pm 20\%$  (unless otherwise specified).

## ORDERING INFORMATION

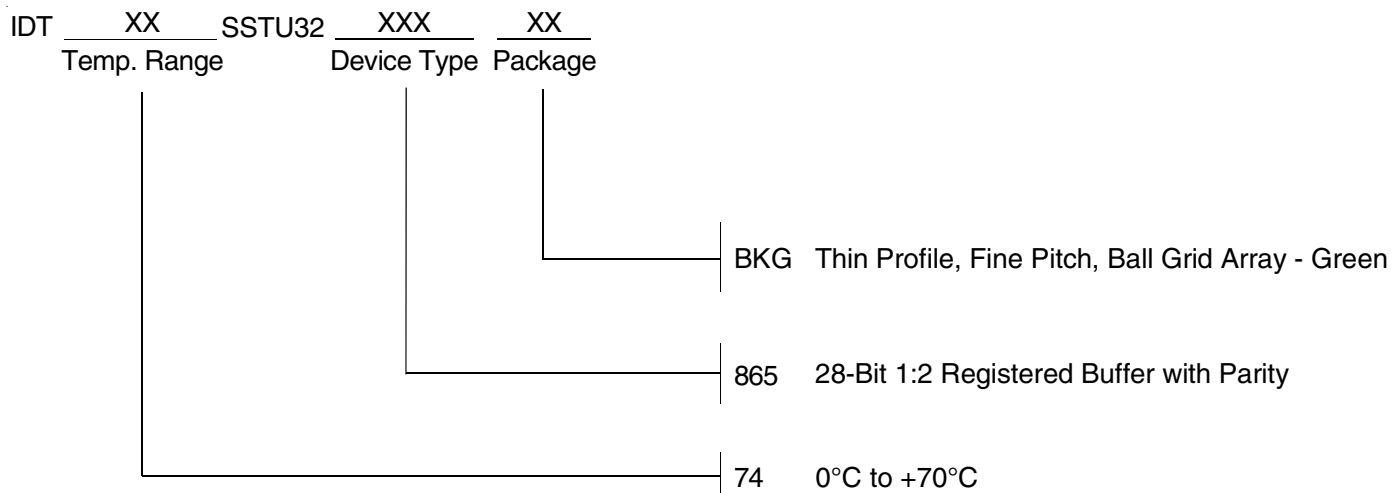

**CORPORATE HEADQUARTERS**  
6024 Silver Creek Valley Road  
San Jose, CA 95138

**for SALES:**  
800-345-7015 or 408-284-8200  
fax: 408-284-2775  
www.idt.com