

MM54C221/MM74C221 Dual Monostable Multivibrator

General Description

The MM54C221/MM74C221 dual monostable multivibrator is a monolithic complementary MOS integrated circuit. Each multivibrator features a negative-transition-triggered input and a positive-transition-triggered input, either of which can be used as an inhibit input, and a clear input.

Once fired, the output pulses are independent of further transitions of the A and B inputs and are a function of the external timing components C_{EXT} and R_{EXT} . The pulse width is stable over a wide range of temperature and V_{CC} .

Pulse stability will be limited by the accuracy of external timing components. The pulse width is approximately defined by the relationship $t_{W(OUT)} \approx C_{EXT} R_{EXT}$. For further information and applications, see AN-138.

Features

- Wide supply voltage range 4.5V to 15V
- Guaranteed noise margin 1.0V
- High noise immunity $0.45 V_{CC}$ (typ.)
- Low power TTL compatibility fan out of 2 driving 74L

Connection Diagrams

Timing Component

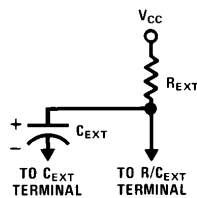

TL/F/5904-1

Dual-In-Line Package

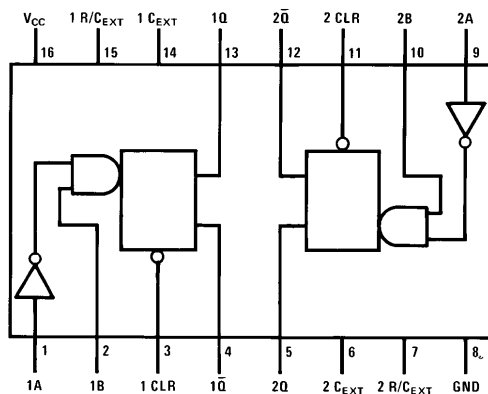







TL/F/5904-2

Top View

Order Number MM54C221 or MM74C221

Truth Table

Clear	Inputs		Outputs	
	A	B	Q	Q̄
L	X	X	L	H
X	H	X	L	H
X	X	L	L	H
H	L	↑		
H	↓	H		

- H = High level
- L = Low level
- ↑ = Transition from low to high
- ↓ = Transition from high to low
-  = One high level pulse
-  = One low level pulse
- X = Irrelevant

Absolute Maximum Ratings (Note 1)

If Military/Aerospace specified devices are required, please contact the National Semiconductor Sales Office/Distributors for availability and specifications.

Voltage at Any Pin	-0.3V to $V_{CC} + 0.3V$
Operating Temperature Range	-55°C to +125°C
MM54C221	-40°C to +85°C
MM74C221	-65°C to +150°C

Power Dissipation	700 mW
Dual-In-Line	500 mW
Small Outline	
Operating V_{CC} Range	4.5V to 15V
Absolute Maximum V_{CC}	18V
$R_{EXT} \geq 80 V_{CC} (\Omega)$	
Lead Temperature (Soldering, 10 seconds)	260°C

DC Electrical Characteristics Max/min limits apply across temperature range, unless otherwise noted

Symbol	Parameter	Conditions	Min	Typ	Max	Units
CMOS to CMOS						
$V_{IN(1)}$	Logical "1" Input Voltage	$V_{CC} = 5V$ $V_{CC} = 10V$	3.5 8.0			V V
$V_{IN(0)}$	Logical "0" Input Voltage	$V_{CC} = 5V$ $V_{CC} = 10V$			1.5 2.0	V V
$V_{OUT(1)}$	Logical "1" Output Voltage	$V_{CC} = 5V, I_O = -10 \mu A$ $V_{CC} = 10V, I_O = -10 \mu A$	4.5 9.0			V V
$V_{OUT(0)}$	Logical "0" Output Voltage	$V_{CC} = 5V, I_O = +10 \mu A$ $V_{CC} = 10V, I_O = +10 \mu A$			0.5 1	V V
$I_{IN(1)}$	Logical "1" Input Current	$V_{CC} = 15V, V_{IN} = 15V$		0.005	1.0	μA
$I_{IN(0)}$	Logical "0" Input Current	$V_{CC} = 15V, V_{IN} = 0V$	-1.0	-0.005		μA
I_{CC}	Supply Current (Standby)	$V_{CC} = 15V, R_{EXT} = \infty$, Q1, Q2 = Logic "0" (Note 3)		0.05	300	μA
I_{CC}	Supply Current (During Output Pulse)	$V_{CC} = 15V, Q1 = \text{Logic "1"}$, $Q2 = \text{Logic "0"}$ (Figure 4)		15		mA
		$V_{CC} = 5V, Q1 = \text{Logic "1"}$, $Q2 = \text{Logic "0"}$ (Figure 4)		2		mA
	Leakage Current at R/ C_{EXT} Pin	$V_{CC} = 15V, V_{C_{EXT}} = 5V$		0.01	3.0	μA
CMOS/LPTTL Interface						
$V_{IN(1)}$	Logical "1" Input Voltage	54C $V_{CC} = 4.5V$	$V_{CC} - 1.5$			V
		74C $V_{CC} = 4.75V$	$V_{CC} - 1.5$			V
$V_{IN(0)}$	Logical "0" Input Voltage	54C $V_{CC} = 4.5V$			0.8	V
		74C $V_{CC} = 4.75V$			0.8	V
$V_{OUT(1)}$	Logical "1" Output Voltage	54C $V_{CC} = 4.5V, I_O = -360 \mu A$	2.4			V
		74C $V_{CC} = 4.75V, I_O = -360 \mu A$	2.4			V
$V_{OUT(0)}$	Logical "0" Output Voltage	54C $V_{CC} = 4.5V, I_O = 360 \mu A$			0.4	V
		74C $V_{CC} = 4.75V, I_O = 360 \mu A$			0.4	V
Output Drive (See 54C/74C Family Characteristics Data Sheet) (Short Circuit Current)						
I_{SOURCE}	Output Source Current (P-Channel)	$V_{CC} = 5V$ $T_A = 25^\circ C, V_{OUT} = 0V$	-1.75			mA
I_{SOURCE}	Output Source Current (P-Channel)	$V_{CC} = 10V$ $T_A = 25^\circ C, V_{OUT} = 0V$	-8			mA
I_{SINK}	Output Sink Current (N-Channel)	$V_{CC} = 5V$ $T_A = 25^\circ C, V_{OUT} = V_{CC}$	1.75			mA
I_{SINK}	Output Sink Current (N-Channel)	$V_{CC} = 10V$ $T_A = 25^\circ C, V_{OUT} = V_{CC}$	8			mA

AC Electrical Characteristics* $T_A = 25^\circ\text{C}$, $C_L = 50\text{ pF}$, unless otherwise noted

Symbol	Parameter	Conditions	Min	Typ	Max	Units
$t_{pd\ A, B}$	Propagation Delay from Trigger Input (A, B) to Output Q, \bar{Q}	$V_{CC} = 5\text{V}$		250	500	ns
		$V_{CC} = 10\text{V}$		120	250	ns
$t_{pd\ CL}$	Propagation Delay from Clear Input (CL) to Output Q, \bar{Q}	$V_{CC} = 5\text{V}$		250	500	ns
		$V_{CC} = 10\text{V}$		120	250	ns
t_S	Time Prior to Trigger Input (A, B) that Clear must be Set	$V_{CC} = 5\text{V}$	150	50		ns
		$V_{CC} = 10\text{V}$	60	20		ns
$t_{W(A, B)}$	Trigger Input (A, B) Pulse Width	$V_{CC} = 5\text{V}$	150	50		ns
		$V_{CC} = 10\text{V}$	70	30		ns
$t_{W(CL)}$	Clear Input (CL) Pulse Width	$V_{CC} = 5\text{V}$	150	50		ns
		$V_{CC} = 10\text{V}$	70	30		ns
$t_{W(OUT)}$	Q or \bar{Q} Output Pulse Width	$V_{CC} = 5\text{V}$, $R_{EXT} = 10\text{k}$, $C_{EXT} = 0\text{ pF}$		900		ns
		$V_{CC} = 10\text{V}$, $R_{EXT} = 10\text{k}$, $C_{EXT} = 0\text{ pF}$		350		ns
		$V_{CC} = 15\text{V}$, $R_{EXT} = 10\text{k}$, $C_{EXT} = 0\text{ pF}$		320		ns
		$V_{CC} = 5\text{V}$, $R_{EXT} = 10\text{k}$, $C_{EXT} = 1000\text{ pF}$ (Figure 1)	9.0	10.6	12.2	μs
		$V_{CC} = 10\text{V}$, $R_{EXT} = 10\text{k}$, $C_{EXT} = 1000\text{ pF}$ (Figure 1)	9.0	10	11	μs
		$V_{CC} = 15\text{V}$, $R_{EXT} = 10\text{k}$, $C_{EXT} = 1000\text{ pF}$ (Figure 1)	8.9	9.8	10.8	μs
		$V_{CC} = 5\text{V}$, $R_{EXT} = 10\text{k}$, $C_{EXT} = 0.1\text{ }\mu\text{F}$ (Figure 2)	900	1020	1200	μs
		$V_{CC} = 10\text{V}$, $R_{EXT} = 10\text{k}$, $C_{EXT} = 0.1\text{ }\mu\text{F}$ (Figure 2)	900	1000	1100	μs
		$V_{CC} = 15\text{V}$, $R_{EXT} = 10\text{k}$, $C_{EXT} = 0.1\text{ }\mu\text{F}$ (Figure 2)	900	990	1100	μs
R_{ON}	ON Resistance of Transistor between R/ C_{EXT} to C_{EXT}	$V_{CC} = 5\text{V}$ (Note 4)		50	150	Ω
		$V_{CC} = 10\text{V}$ (Note 4)		25	65	Ω
		$V_{CC} = 15\text{V}$ (Note 4)		16.7	45	Ω
	Output Duty Cycle	$R = 10\text{k}$, $C = 1000\text{ pF}$			90	%
		$R = 10\text{k}$, $C = 0.1\text{ }\mu\text{F}$ (Note 5)			90	%
C_{IN}	Input Capacitance	R/ C_{EXT} Input (Note 2)		15	25	pF
		Any Other Input (Note 2)		5		pF

*AC Parameters are guaranteed by DC correlated testing.

Note 1: "Absolute Maximum Ratings" are those values beyond which the safety of the device cannot be guaranteed. Except for "Operating Temperature Range" they are not meant to imply that the devices should be operated at these limits. The table of "Electrical Characteristics" provides conditions for actual device operation.

Note 2: Capacitance is guaranteed by periodic testing.

Note 3: In Standby (Q = Logic "0") the power dissipated equals the leakage current plus V_{CC}/R_{EXT} .

Note 4: See AN-138 for detailed explanation R_{ON} .

Note 5: Maximum output duty cycle = $R_{EXT}/R_{EXT} + 1000$.

Typical Performance Characteristics

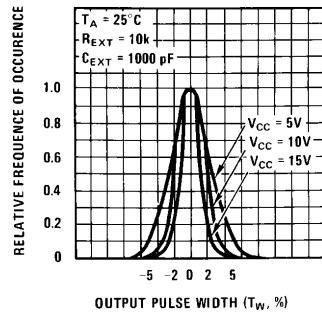

0% Point pulse width:

At $V_{CC} = 5V$, $T_W = 10.6\ \mu\text{s}$

At $V_{CC} = 10V$, $T_W = 10\ \mu\text{s}$

At $V_{CC} = 15V$, $T_W = 9.8\ \mu\text{s}$

Percentage of units within +4%:

At $V_{CC} = 5V$, 90% of units

At $V_{CC} = 10V$, 95% of units

At $V_{CC} = 15V$, 98% of units

TL/F/5904-3

FIGURE 1. Typical Distribution of Units for Output Pulse Width

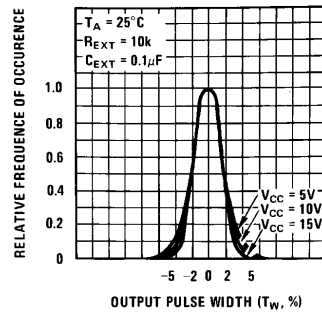

0% Point pulse width:

At $V_{CC} = 5V$, $T_W = 1020\ \mu\text{s}$

At $V_{CC} = 10V$, $T_W = 1000\ \mu\text{s}$

At $V_{CC} = 15V$, $T_W = 982\ \mu\text{s}$

Percentage of units within +4%:

At $V_{CC} = 5V$, 95% of units

At $V_{CC} = 10V$, 97% of units

At $V_{CC} = 15V$, 98% of units

TL/F/5904-4

FIGURE 2. Typical Distribution of Units for Output Pulse Width

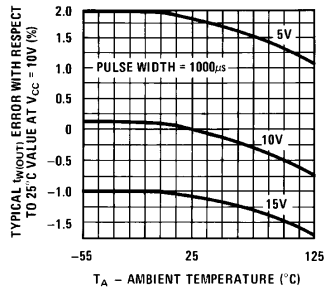

TL/F/5904-5

FIGURE 3. Typical Variation in Output Pulse Width vs Temperature

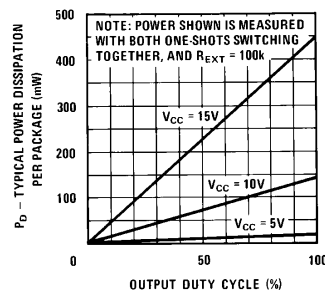

TL/F/5904-6

FIGURE 4. Typical Power Dissipation per Package

Switching Time Waveforms

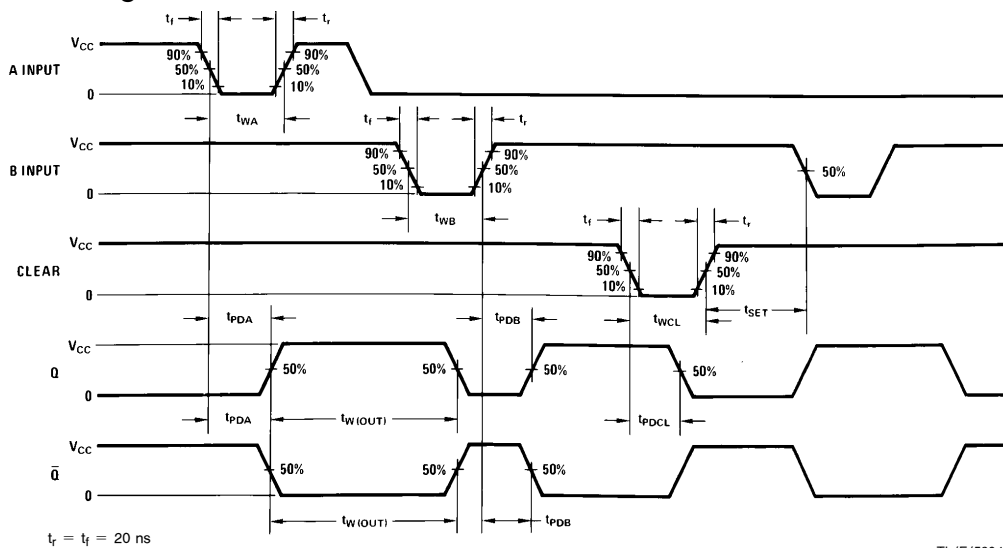

TL/F/5904-7

Physical Dimensions inches (millimeters)

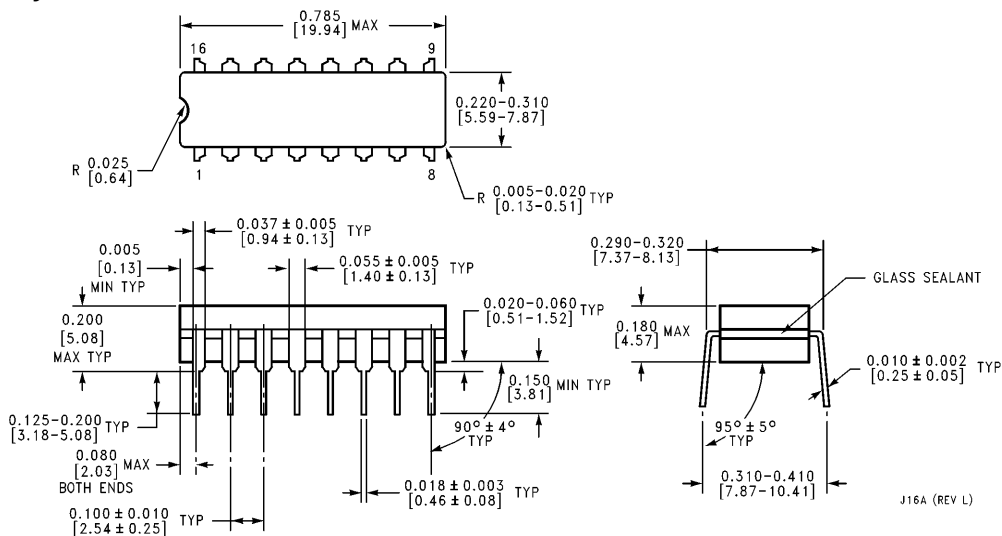

Ceramic Dual-In-Line Package (J)
Order Number MM54C221J or MM74C221C
NS Package Number J16A

J16A (REV L)

Physical Dimensions inches (millimeters) (Continued)

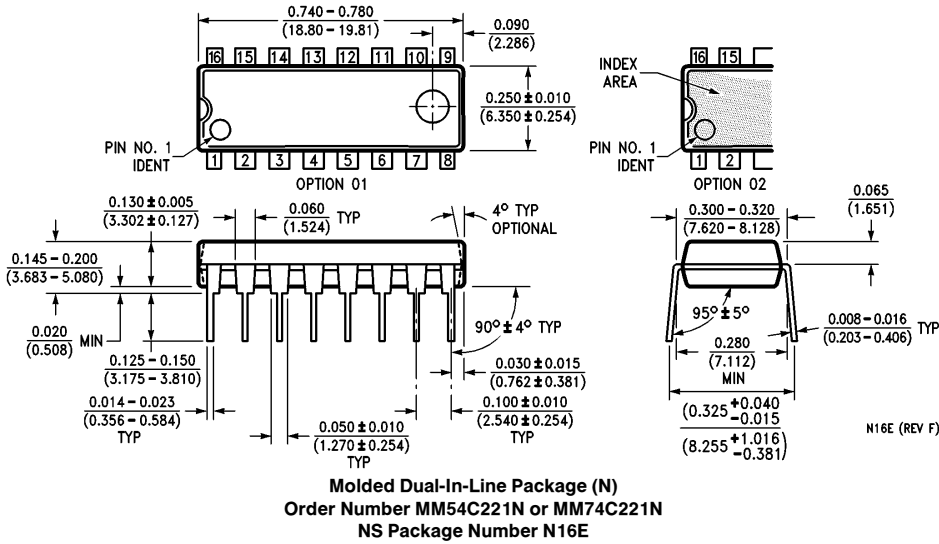

LIFE SUPPORT POLICY

NATIONAL'S PRODUCTS ARE NOT AUTHORIZED FOR USE AS CRITICAL COMPONENTS IN LIFE SUPPORT DEVICES OR SYSTEMS WITHOUT THE EXPRESS WRITTEN APPROVAL OF THE PRESIDENT OF NATIONAL SEMICONDUCTOR CORPORATION. As used herein:

1. Life support devices or systems are devices or systems which, (a) are intended for surgical implant into the body, or (b) support or sustain life, and whose failure to perform, when properly used in accordance with instructions for use provided in the labeling, can be reasonably expected to result in a significant injury to the user.
2. A critical component is any component of a life support device or system whose failure to perform can be reasonably expected to cause the failure of the life support device or system, or to affect its safety or effectiveness.

 <p>National Semiconductor Corporation 1111 West Bardin Road Arlington, TX 76017 Tel: 1(800) 272-9959 Fax: 1(800) 737-7018</p>	<p>National Semiconductor Europe Fax: (+49) 0-180-530 85 86 Email: cnjwge@tevm2.nsc.com Deutsch Tel: (+49) 0-180-530 85 85 English Tel: (+49) 0-180-532 78 32 Français Tel: (+49) 0-180-532 93 58 Italiano Tel: (+49) 0-180-534 16 80</p>	<p>National Semiconductor Hong Kong Ltd. 19th Floor, Straight Block, Ocean Centre, 5 Canton Rd. Tsimshatsui, Kowloon Hong Kong Tel: (852) 2737-1600 Fax: (852) 2736-9960</p>	<p>National Semiconductor Japan Ltd. Tel: 81-043-299-2309 Fax: 81-043-299-2408</p>
--	--	---	---

National does not assume any responsibility for use of any circuitry described, no circuit patent licenses are implied and National reserves the right at any time without notice to change said circuitry and specifications.