

Product Features

- PI74FCT521T is pin compatible with bipolar FAST™ Series at a higher speed and lower power consumption
- TTL input and output levels
- Extremely low static power
- Hysteresis on all inputs
- Industrial operating temperature range: -40°C to $+85^{\circ}\text{C}$
- Packages available:
 - 20-pin 209 mil wide plastic SSOP (H)
 - 20-pin 173 mil wide plastic TSSOP (L)
 - 20-pin 300 mil wide plastic DIP (P)
 - 20-pin 150 mil wide plastic QSOP (Q)
 - 20-pin 150 mil wide plastic TQSOP (R)
 - 20-pin 300 mil wide plastic SOIC (S)

Product Description

Pericom Semiconductor's PI74FCT series of logic circuits are produced in the Company's advanced 0.8 micron CMOS technology, achieving industry leading speed grades.

The PI74FCT521T is an 8-bit identity comparator. When two words of up to eight bits are compared, a bit-for-bit match of the two words provides a LOW output. The comparison can be extended over multiple words by the expansion input. The expansion input $\bar{I}_{A=B}$ also serves as an active LOW enable input.

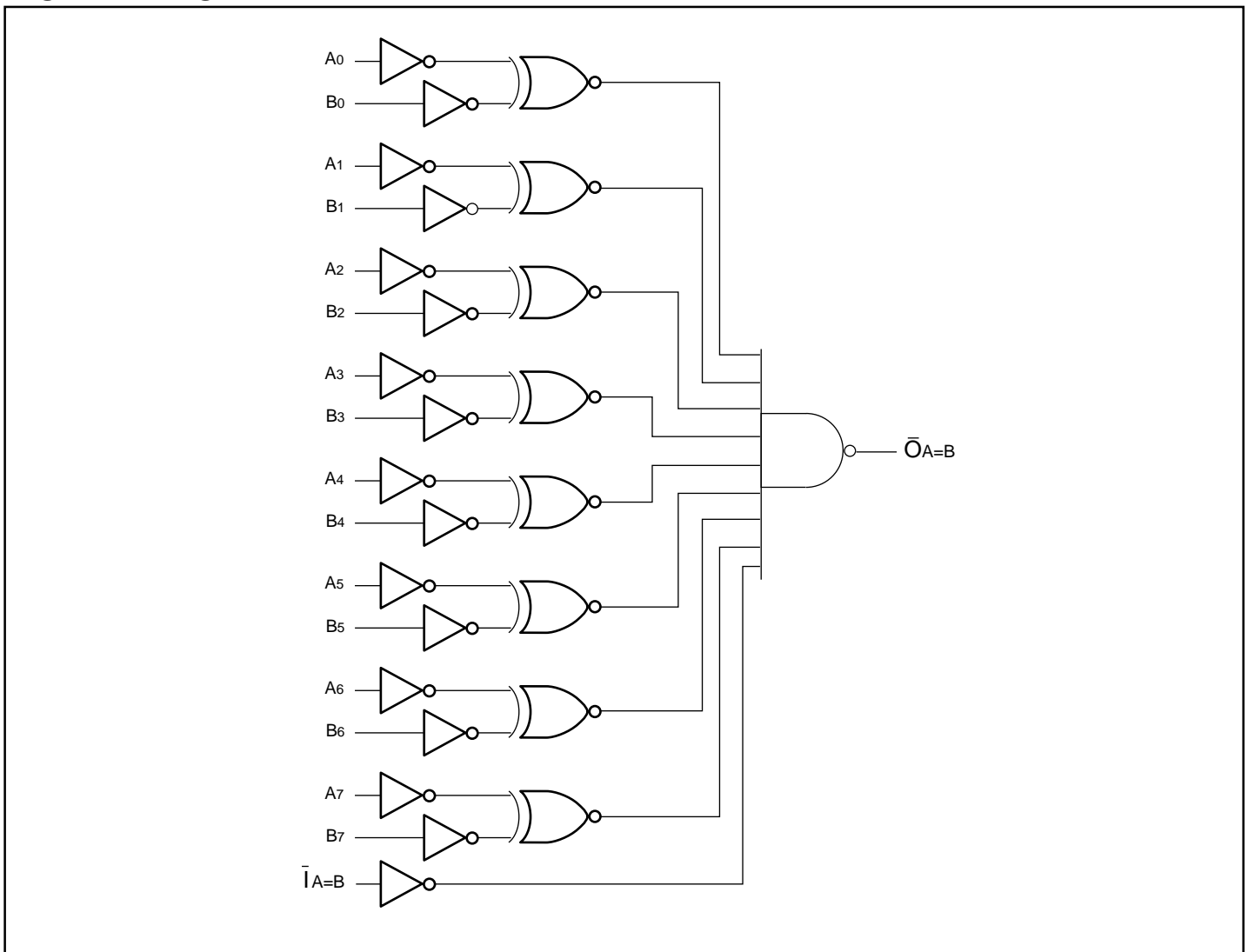
Logic Block Diagram

Product Pin Description

Pin Name	Description
$\bar{I}A=B$	Expansion or Enable Input (Active LOW)
$\bar{O}A=B$	Identity Output (Active LOW)
A0–A7	Word A Inputs
B0–B7	Word B Inputs
GND	Ground
VCC	Power

Truth Table⁽¹⁾

Inputs		Output
$\bar{I}A=B$	A, B	$\bar{O}A=B$
L	A = B*	L
L	A ≠ B	H
H	A = B*	H
H	A ≠ B	H

NOTE: 1. H = High Voltage Level
 L = Low Voltage Level,
 *A0 = B0, A1 = B1, A2 = B2, etc.

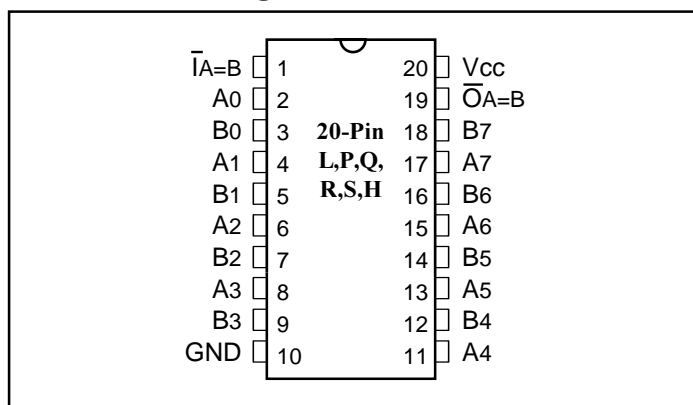
Product Pin Configuration

Maximum Ratings

(Above which the useful life may be impaired. For user guidelines, not tested.)

Storage Temperature	-65°C to +150°C
Ambient Temperature with Power Applied	-40°C to +85°C
Supply Voltage to Ground Potential (Inputs & V _{CC} Only)	-0.5V to +7.0V
Supply Voltage to Ground Potential (Outputs & D/O Only)	-0.5V to +7.0V
DC Input Voltage	-0.5V to +7.0V
DC Output Current	120 mA
Power Dissipation	0.5W

Note:

Stresses greater than those listed under MAXIMUM RATINGS may cause permanent damage to the device. This is a stress rating only and functional operation of the device at these or any other conditions above those indicated in the operational sections of this specification is not implied. Exposure to absolute maximum rating conditions for extended periods may affect reliability.

DC Electrical Characteristics (Over the Operating Range, T_A = -40°C to +85°C, V_{CC} = 5V ± 5%)

Parameters	Description	Test Conditions ⁽¹⁾		Min.	Typ ⁽²⁾	Max.	Units
V _{OH}	Output HIGH Voltage	V _{CC} = Min., V _{IN} = V _{IH} or V _{IL}	I _{OH} = -15.0 mA	2.4	3.0		V
V _{OL}	Output LOW Current	V _{CC} = Min., V _{IN} = V _{IH} or V _{IL}	I _{OL} = 48 mA		0.3	0.50	V
V _{IH}	Input HIGH Voltage	Guaranteed Logic HIGH Level		2.0			V
V _{IL}	Input LOW Voltage	Guaranteed Logic LOW Level				0.8	V
I _{IH}	Input HIGH Current	V _{CC} = Max.	V _{IN} = V _{CC}			1	μA
I _{IL}	Input LOW Current	V _{CC} = Max.	V _{IN} = GND			-1	μA
V _{IK}	Clamp Diode Voltage	V _{CC} = Min., I _{IN} = -18 mA			-0.7	-1.2	V
I _{OS}	Short Circuit Current	V _{CC} = Max. ⁽³⁾ , V _{OUT} = GND		-60	-120		mA
I _{OFF}	Power Down Disable	V _{CC} = GND, V _{OUT} = 4.5V		—	—	100	μA
V _H	Input Hysteresis				200		mV

Capacitance (T_A = 25°C, f = 1 MHz)

Parameters ⁽⁴⁾	Description	Test Conditions	Typ	Max.	Units
C _{IN}	Input Capacitance	V _{IN} = 0V	6	10	pF
C _{OUT}	Output Capacitance	V _{OUT} = 0V	8	12	pF

Notes:

1. For Max. or Min. conditions, use appropriate value specified under Electrical Characteristics for the applicable device type.
2. Typical values are at V_{CC} = 5.0V, +25°C ambient and maximum loading.
3. Not more than one output should be shorted at one time. Duration of the test should not exceed one second.
4. This parameter is determined by device characterization but is not production tested.

Power Supply Characteristics

Parameters	Description	Test Conditions ⁽¹⁾		Min.	Typ ⁽²⁾	Max.	Units
I _{CC}	Quiescent Power Supply Current	V _{CC} = Max.	V _{IN} = GND or V _{CC}		0.1	500	μA
ΔI _{CC}	Supply Current per Input @ TTL HIGH	V _{CC} = Max.	V _{IN} = 3.4V ⁽³⁾		0.5	2.0	mA
I _{CCD}	Supply Current per Input per MHz ⁽⁴⁾	V _{CC} = Max., Outputs Open One Input Toggling 50% Duty Cycle	V _{IN} = V _{CC} V _{IN} = GND		0.15	0.25	mA/ MHz
I _C	Total Power Supply Current ⁽⁶⁾	V _{CC} = Max., Outputs Open f _i = 10 MHz 50% Duty Cycle One Bit Toggling	V _{IN} = V _{CC} V _{IN} = GND		1.5	3.5 ⁽⁵⁾	mA
			V _{IN} = 3.4V V _{IN} = GND		1.8	4.5 ⁽⁵⁾	

Notes:

- For conditions shown as Max. or Min., use appropriate value specified under Electrical Characteristics for the applicable device.
- Typical values are at V_{CC} = 5.0V, +25°C ambient.
- Per TTL driven input (V_{IN} = 3.4V); all other inputs at V_{CC} or GND.
- This parameter is not directly testable, but is derived for use in Total Power Supply Calculations.
- Values for these conditions are examples of the I_{CC} formula. These limits are guaranteed but not tested.

$$I_C = I_{\text{QUIESCENT}} + I_{\text{INPUTS}} + I_{\text{DYNAMIC}}$$

$$I_C = I_{CC} + \Delta I_{CC} D_{HT} + I_{CCD} (f_{CP}/2 + f_i N_i)$$

I_{CC} = Quiescent Current

ΔI_{CC} = Power Supply Current for a TTL High Input (V_{IN} = 3.4V)

D_H = Duty Cycle for TTL Inputs High

N_T = Number of TTL Inputs at D_H

I_{CCD} = Dynamic Current Caused by an Input Transition Pair (HLH or LHL)

f_{CP} = Clock Frequency for Register Devices (Zero for Non-Register Devices)

f_i = Input Frequency

N_i = Number of Inputs at f_i

All currents are in milliamps and all frequencies are in megahertz.

Switching Characteristics over Operating Range

Parameters	Description	Conditions ⁽¹⁾	521T		521AT		521BT		521CT		521DT		Unit
			Com.		Com.		Com.		Com.		Com.		
			Min	Max	Min	Max	Min	Max	Min	Max	Min	Max	
t _{PLH}	Propagation Delay	C _L = 50 pF R _L = 500Ω	1.5	10.0	1.5	7.2	1.5	5.5	1.5	4.5	1.5	4.2	ns
t _{PHL}	A _N or B _N to $\bar{O}_A=B$												
t _{PLH}	Propagation Delay		1.5	9.0	1.5	6.0	1.5	4.6	1.5	4.1	1.5	3.8	ns
t _{PHL}	$\bar{I}_A=B$ to $\bar{O}_A=B$												

Notes:

- See Test Circuit and Waveforms
- Minimum limits are guaranteed but not tested on Propagation Delays.

20-pin 173 mil wide plastic TSSOP (L) Package

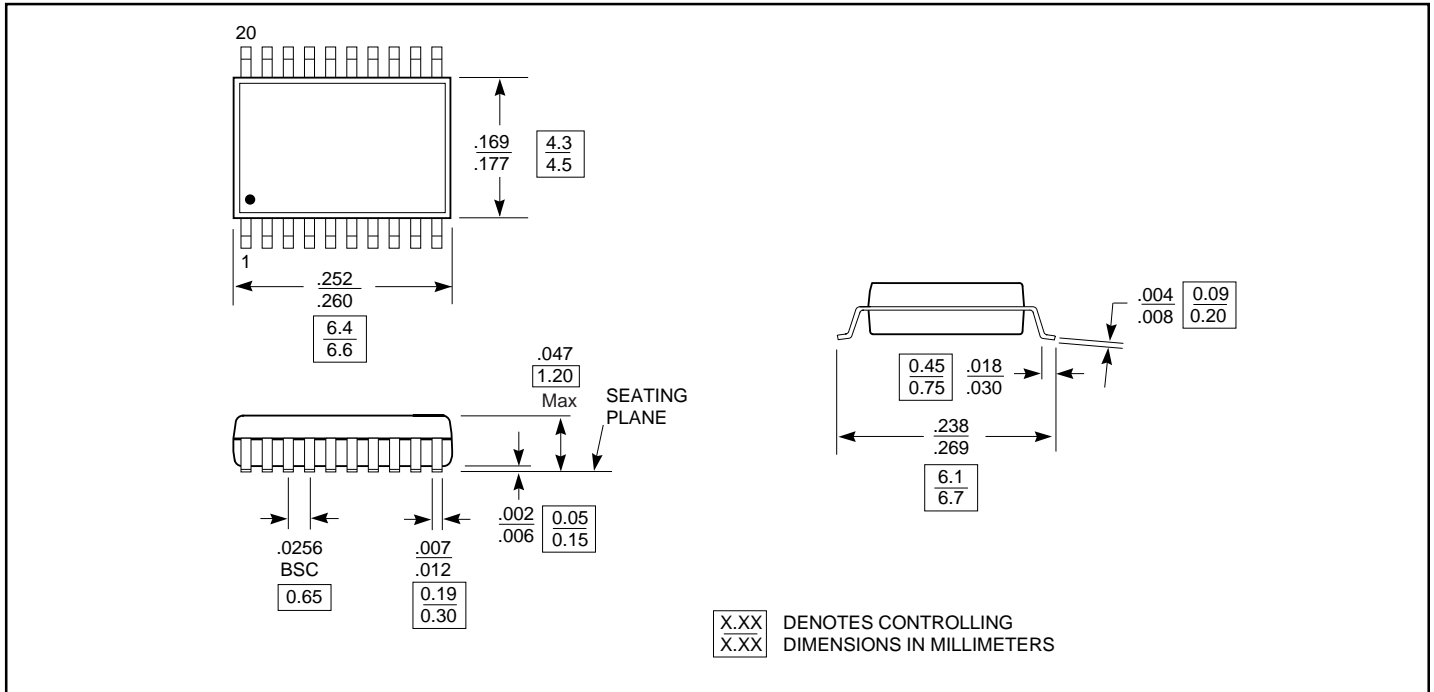

20-pin 300 mil wide plastic DIP (P)

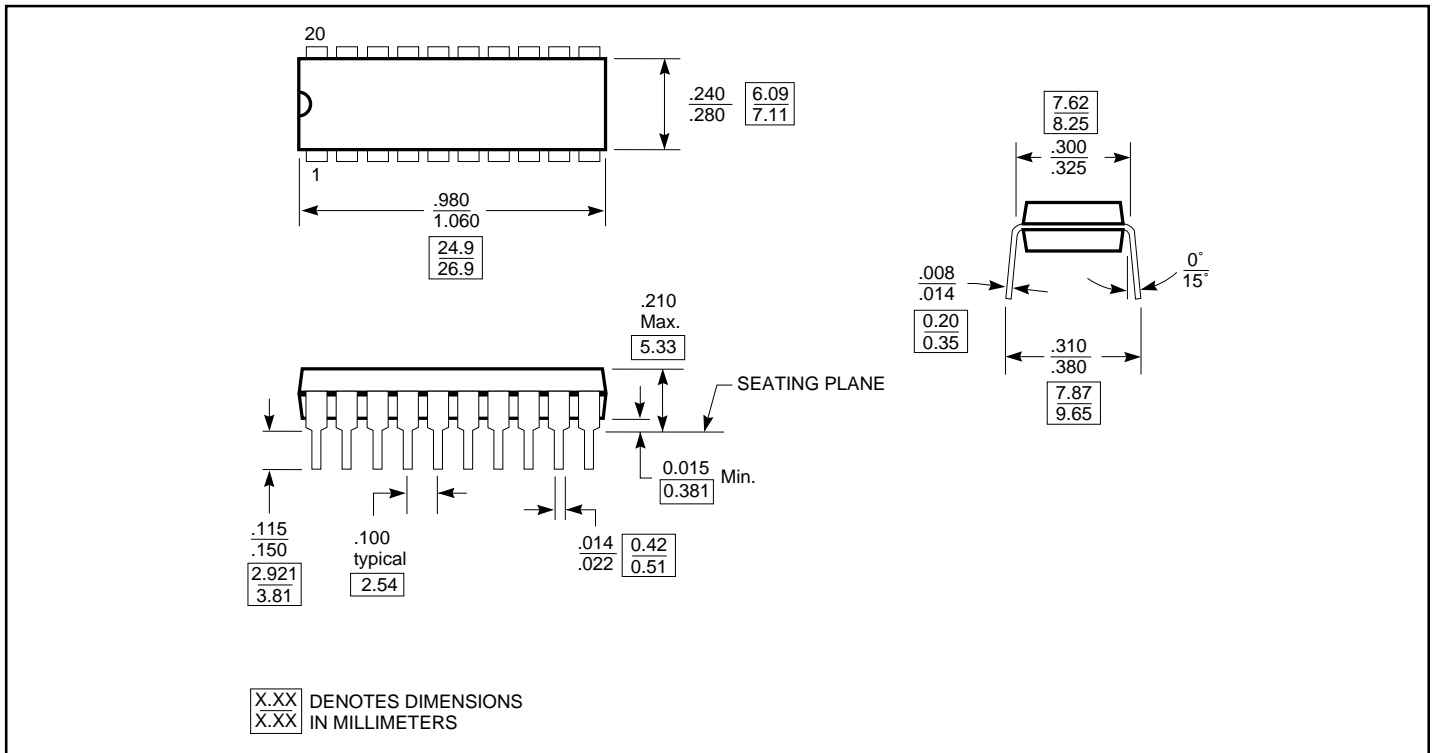

20-pin 300 mil wide plastic SOIC (S) Package

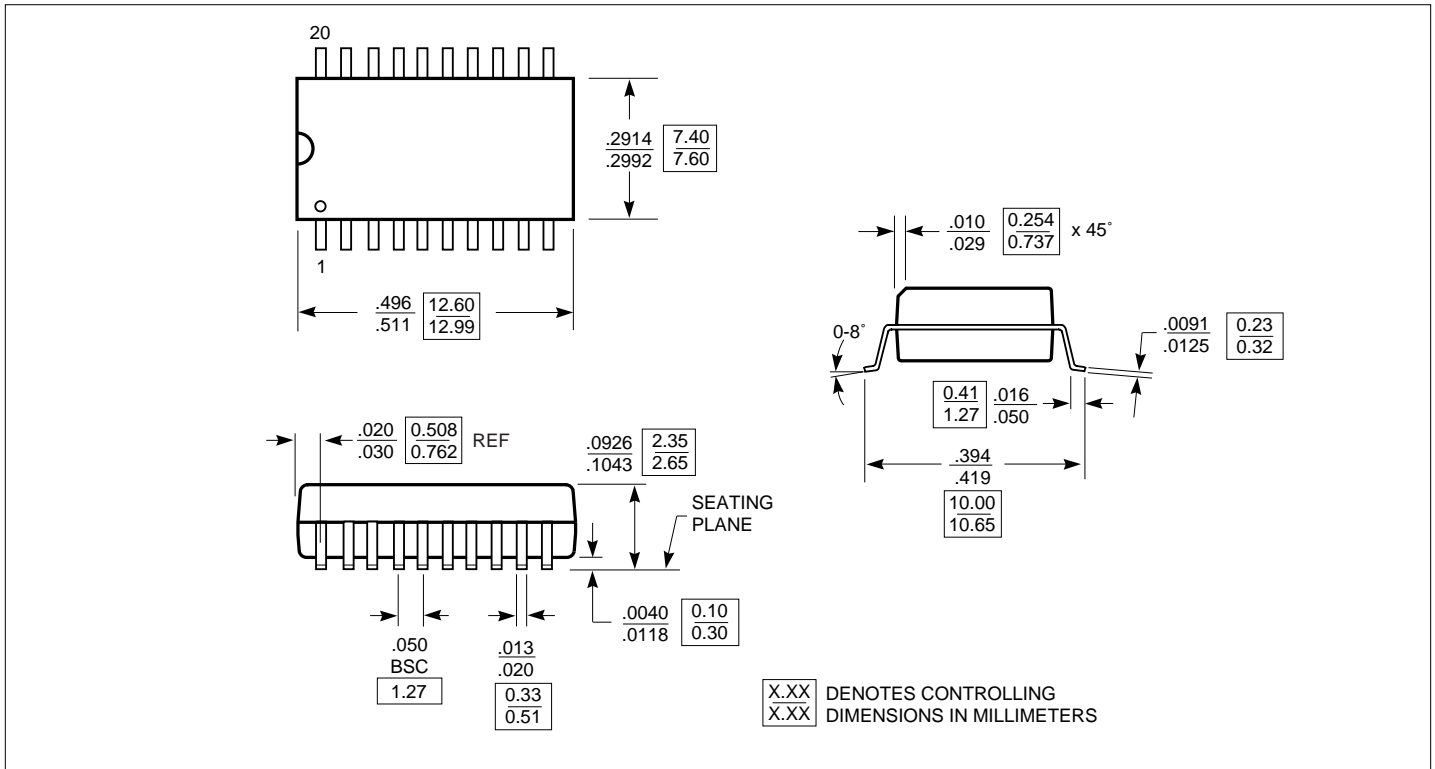

20-pin 209 mil wide plastic SSOP (H) Package

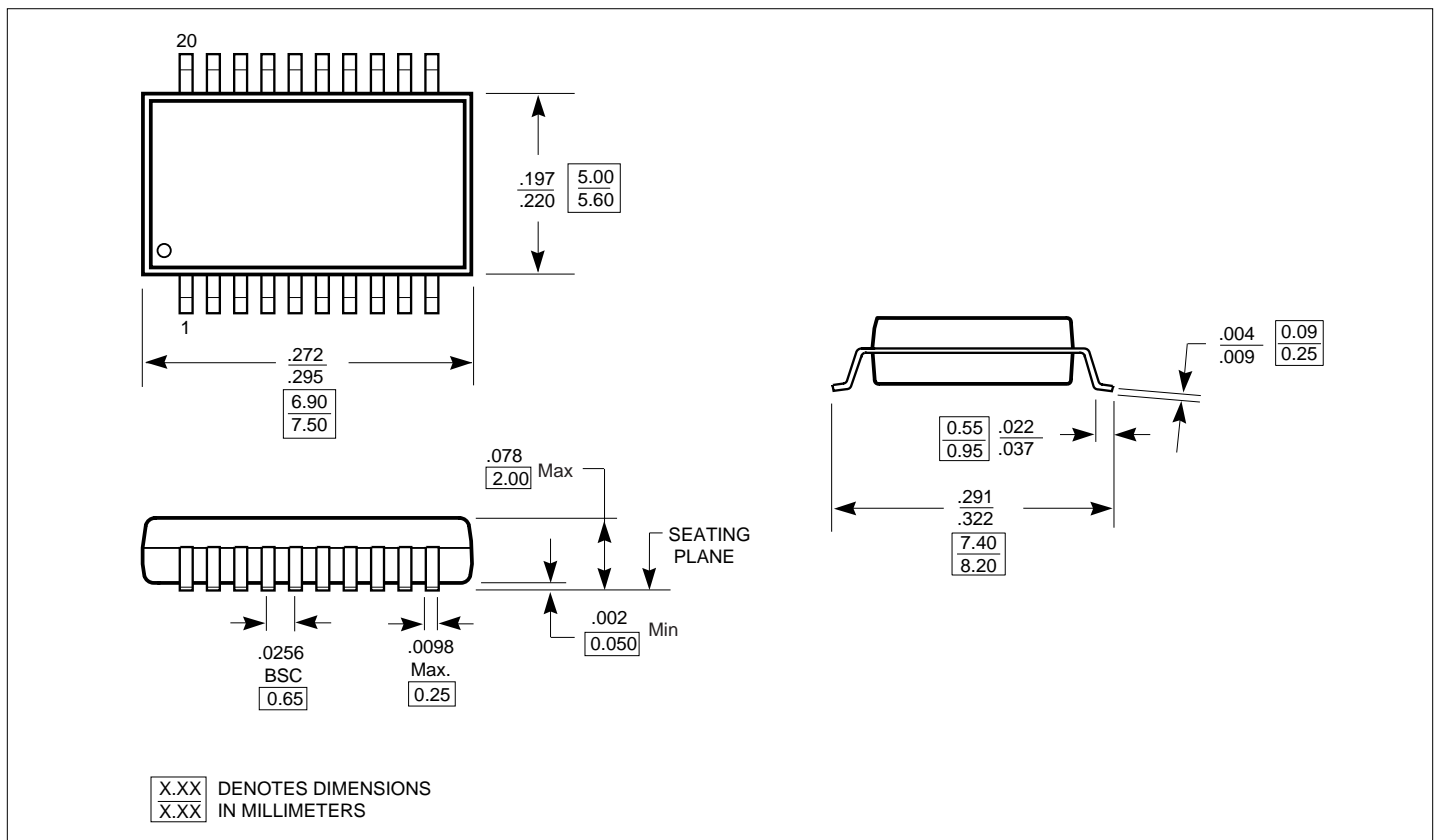

Ordering Information

Part	Pin Package
PI74FCT521TH	20-pin 209 mil wide plastic SSOP (H)
PI74FCT521TL	20-pin 173 mil wide plastic TSSOP (L)
PI74FCT521TP	20-pin 300 mil wide plastic PDIP (P)
PI74FCT521TQ	20-pin 150 mil wide plastic QSOP (Q)
PI74FCT521TR	20-pin 150 mil wide plastic TQSOP (R)
PI74FCT521TS	20-pin 300mil wide plastic SOIC (S)

Part Marking Information

Pericom's standard product mark follows our standard part number ordering information, except for those products with a speed letter code. For marking purposes, the speed letter code mark is placed after the package code letter, rather than after the device number as it is ordered.

Although all products are marked immediately after assembly to assure material traceability, Pericom does not usually mark the speed code at that time. After electrical test screening and speed binning has been completed, we then perform an add mark operation which places the speed code letter at the end of the complete part number.

Please refer to the example shown below:
Part Number as ordered: PI74FCT245ATQ
Example of Part Number as marked:

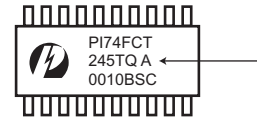

"A" is the speed code letter identifier

Notes:

- 1) 8-pin DIP, 8-pin SOIC, 8-pin TSSOP, 14-pin SOIC, 16-pin QSOP, SC70, MSOP, and SOT23 packages are not marked with the Pericom logo due to space limitations on the package.