

SN74LS682, SN74LS684, SN74LS688



ON Semiconductor

<http://onsemi.com>

8-Bit Magnitude Comparators

The SN74LS682, 684, 688 are 8-bit magnitude comparators. These device types are designed to perform comparisons between two eight-bit binary or BCD words. All device types provide $\overline{P} = \overline{Q}$ outputs and the LS682 and LS684 have $\overline{P} > \overline{Q}$ outputs also.

The LS682, LS684 and LS688 are totem pole devices. The LS682 has a 20 k Ω pullup resistor on the Q inputs for analog or switch data.

TYPE	$\overline{P} = \overline{Q}$	$\overline{P} > \overline{Q}$	OUTPUT ENABLE	OUTPUT CONFIGURATION	PULLUP
LS682	yes	yes	no	totem-pole	yes
LS684	yes	yes	no	totem-pole	no
LS688	yes	no	yes	totem-pole	no

GUARANTEED OPERATING RANGES

Symbol	Parameter	Min	Typ	Max	Unit
V _{CC}	Supply Voltage	4.75	5.0	5.25	V
T _A	Operating Ambient Temperature Range	0	25	70	°C
I _{OH}	Output Current - High			-0.4	mA
I _{OL}	Output Current - Low			24	mA

LOW
POWER
SCHOTTKY

MARKING DIAGRAMS

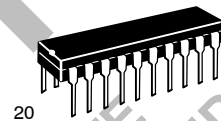

PDIP-20
N SUFFIX
CASE 738

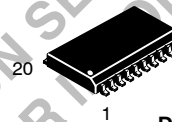
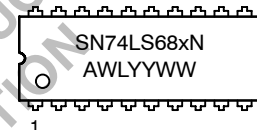

SOIC-20
DW SUFFIX
CASE 751D

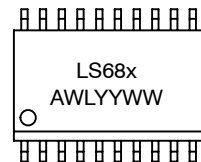

x = 2, 4, or 8
A = Assembly Location
WL = Wafer Lot
YY = Year
WW = Work Week

ORDERING INFORMATION

Device	Package	Shipping
SN74LS682N	PDIP-20	1440 Units/Box
SN74LS682DW	SOIC-WIDE	38 Units/Rail
SN74LS682DWR2	SOIC-WIDE	2500/Tape & Reel
SN74LS684N	PDIP-20	1440 Units/Box
SN74LS684DW	SOIC-WIDE	38 Units/Rail
SN74LS684DWR2	SOIC-WIDE	2500/Tape & Reel
SN74LS688N	PDIP-20	1440 Units/Box
SN74LS688DW	SOIC-WIDE	38 Units/Rail
SN74LS688DWR2	SOIC-WIDE	2500/Tape & Reel

SN74LS682, SN74LS684, SN74LS688

CONNECTION DIAGRAMS (TOP VIEW)

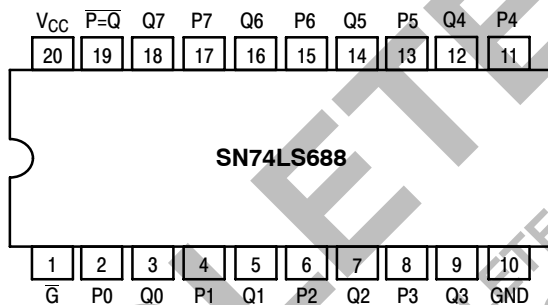
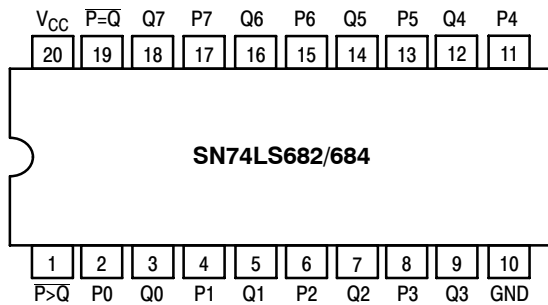

FUNCTION TABLE

INPUTS		OUTPUTS		
DATA	ENABLES		$\overline{P=Q}$	$P>Q$
P, Q	G, GT	G2		
$\overline{P=Q}$	L	L	L	H
$\overline{P>Q}$	L	L	H	L
$\overline{P<Q}$	L	L	H	L
X	H	H	H	H

H = HIGH Level, L = LOW Level, X = Irrelevant

SN74LS682, SN74LS684, SN74LS688

DC CHARACTERISTICS OVER OPERATING TEMPERATURE RANGE (unless otherwise specified)

Symbol	Parameter	Limits			Unit	Test Conditions	
		Min	Typ	Max			
V_{IH}	Input HIGH Voltage	2.0			V	Guaranteed Input HIGH Voltage for All Inputs	
V_{IL}	Input LOW Voltage			0.8	V	Guaranteed Input LOW Voltage for All Inputs	
V_{IK}	Input Clamp Diode Voltage		-0.65	-1.5	V	$V_{CC} = \text{MIN}$, $I_{IN} = -18 \text{ mA}$	
V_{OH}	Output HIGH Voltage	2.7	3.5		V	$V_{CC} = \text{MIN}$, $I_{OH} = \text{MAX}$, $V_{IN} = V_{IH}$ or V_{IL} per Truth Table	
V_{OL}	Output LOW Voltage		0.25	0.4	V	$I_{OL} = 12 \text{ mA}$	
			0.35	0.5	V	$I_{OL} = 24 \text{ mA}$	
I_{IH}	Input HIGH Current			20	μA	$V_{CC} = \text{MAX}$, $V_{IN} = 2.7 \text{ V}$	
		LS682-Q Inputs			0.1	mA	$V_{CC} = \text{MAX}$, $V_{IN} = 5.5 \text{ V}$
		Others			0.1	mA	$V_{CC} = \text{MAX}$, $V_{IN} = 7.0 \text{ V}$
I_{IL}	Input LOW Current	LS682-Q Inputs			-0.4	mA	$V_{CC} = \text{MAX}$, $V_{IN} = 0.4 \text{ V}$
		Others			-0.2	mA	
I_{OS}	Short Circuit Current (Note 1)	-30		-130	mA	$V_{CC} = \text{MAX}$	
I_{CC}	Power Supply Current	LS682			70	mA	$V_{CC} = \text{MAX}$
		LS684			65	mA	
		LS688			65	mA	

1. Not more than one output should be shorted at a time, nor for more than 1 second.

SN74LS682, SN74LS684, SN74LS688

LOGIC DIAGRAMS

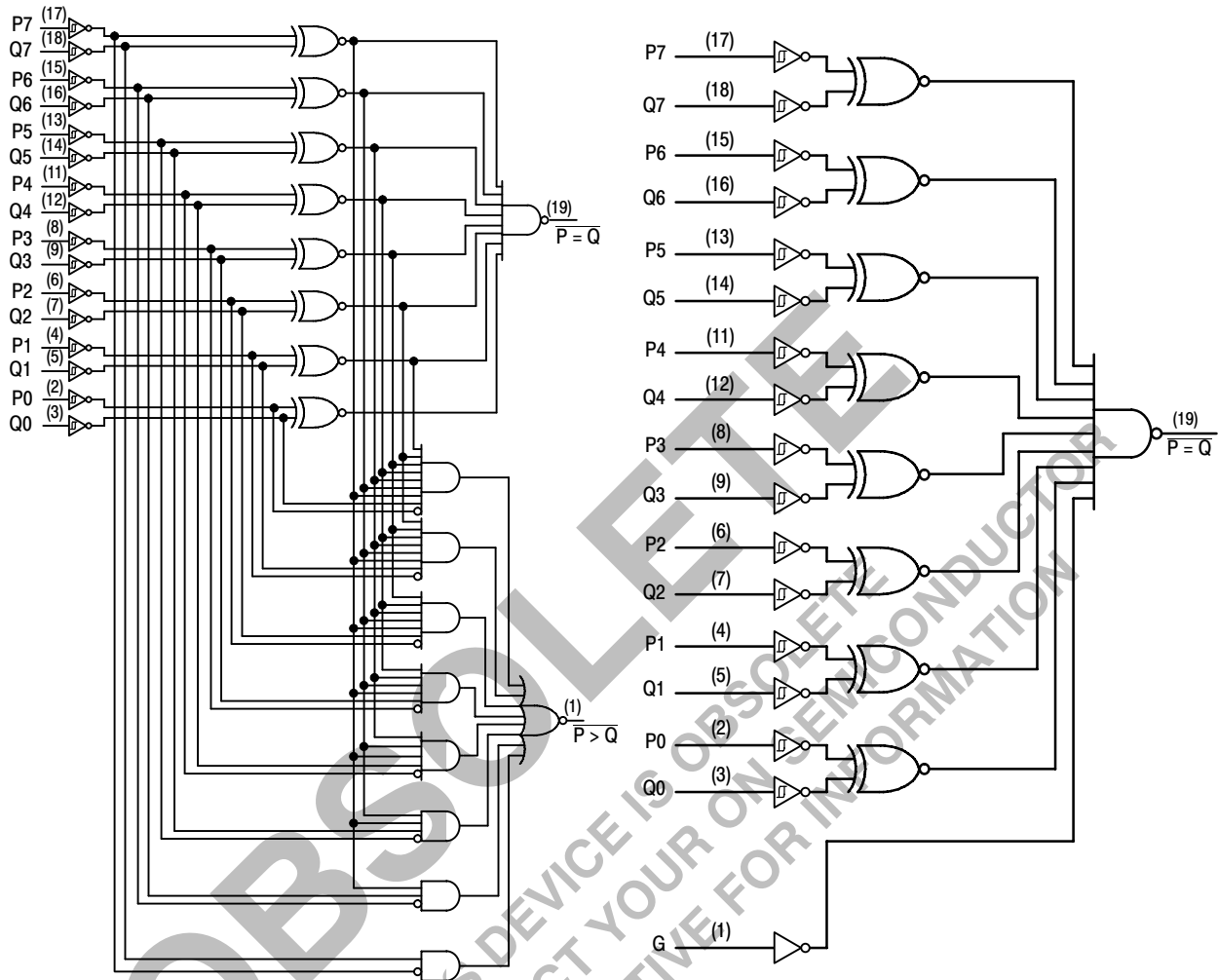

SN74LS682 and LS684

SN74LS688

SN74LS682, SN74LS684, SN74LS688

AC CHARACTERISTICS ($T_A = 25^\circ\text{C}$)

SN74LS682

Symbol	Parameter	Limits			Unit	Test Conditions
		Min	Typ	Max		
t_{PLH} t_{PHL}	Propagation Delay, P to $\overline{P} = \overline{Q}$		13 15	25 25	ns	$V_{CC} = 5.0\text{ V}$ $C_L = 45\text{ pF}$ $R_L = 667\ \Omega$
t_{PLH} t_{PHL}	Propagation Delay, Q to $\overline{P} = \overline{Q}$		14 15	25 25	ns	
t_{PLH} t_{PHL}	Propagation Delay, P to $\overline{P} > \overline{Q}$		20 15	30 30	ns	
t_{PLH} t_{PHL}	Propagation Delay, Q to $\overline{P} > \overline{Q}$		21 19	30 30	ns	

SN74LS684

Symbol	Parameter	Limits			Unit	Test Conditions
		Min	Typ	Max		
t_{PLH} t_{PHL}	Propagation Delay, P to $\overline{P} = \overline{Q}$		15 17	25 25	ns	$V_{CC} = 5.0\text{ V}$ $C_L = 45\text{ pF}$ $R_L = 667\ \Omega$
t_{PLH} t_{PHL}	Propagation Delay, Q to $\overline{P} = \overline{Q}$		16 15	25 25	ns	
t_{PLH} t_{PHL}	Propagation Delay, P to $\overline{P} > \overline{Q}$		22 17	30 30	ns	
t_{PLH} t_{PHL}	Propagation Delay, Q to $\overline{P} > \overline{Q}$		24 20	30 30	ns	

SN74LS688

Symbol	Parameter	Limits			Unit	Test Conditions
		Min	Typ	Max		
t_{PLH} t_{PHL}	Propagation Delay, P to $\overline{P} = \overline{Q}$		12 17	18 23	ns	$V_{CC} = 5.0\text{ V}$ $C_L = 45\text{ pF}$ $R_L = 667\ \Omega$
t_{PLH} t_{PHL}	Propagation Delay, Q to $\overline{P} = \overline{Q}$		12 17	18 23	ns	
t_{PLH} t_{PHL}	Propagation Delay, \overline{G} , $\overline{G1}$ to $\overline{P} = \overline{Q}$		12 13	18 20	ns	

SN74LS682, SN74LS684, SN74LS688

PACKAGE DIMENSIONS

N SUFFIX
PLASTIC PACKAGE
 CASE 738-03
 ISSUE E

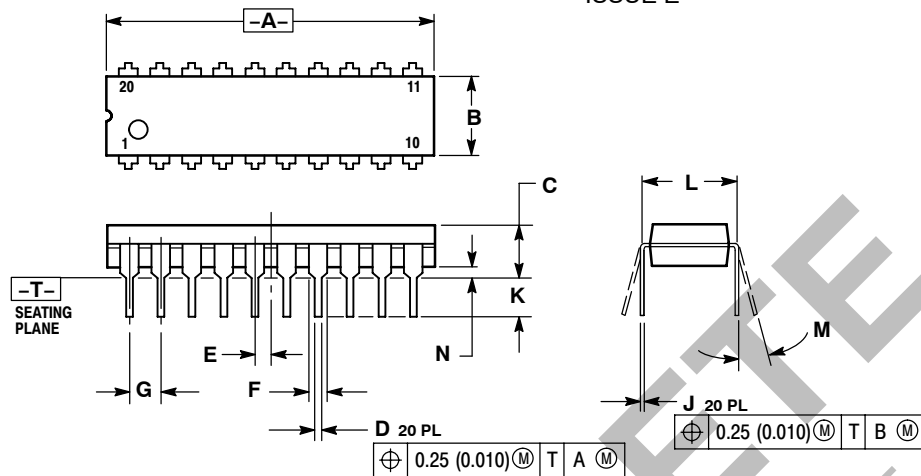

NOTES:

1. DIMENSIONING AND TOLERANCING PER ANSI Y14.5M, 1982.
2. CONTROLLING DIMENSION: INCH.
3. DIMENSION L TO CENTER OF LEAD WHEN FORMED PARALLEL.
4. DIMENSION B DOES NOT INCLUDE MOLD FLASH.

DIM	INCHES		MILLIMETERS	
	MIN	MAX	MIN	MAX
A	1.010	1.070	25.66	27.17
B	0.240	0.260	6.10	6.60
C	0.150	0.180	3.81	4.57
D	0.015	0.022	0.39	0.55
E	0.050 BSC		1.27 BSC	
F	0.050 0.070		1.27 1.77	
G	0.100 BSC		2.54 BSC	
J	0.008	0.015	0.21	0.38
K	0.110	0.140	2.80	3.55
L	0.800 BSC		7.62 BSC	
M	0°	15°	0°	15°
N	0.020	0.040	0.51	1.01

OBSOLETE

THIS DEVICE IS OBSOLETE
 PLEASE CONTACT YOUR ON SEMICONDUCTOR
 REPRESENTATIVE FOR INFORMATION

SN74LS682, SN74LS684, SN74LS688

PACKAGE DIMENSIONS

DW SUFFIX
 PLASTIC SOIC PACKAGE
 CASE 751D-05
 ISSUE F

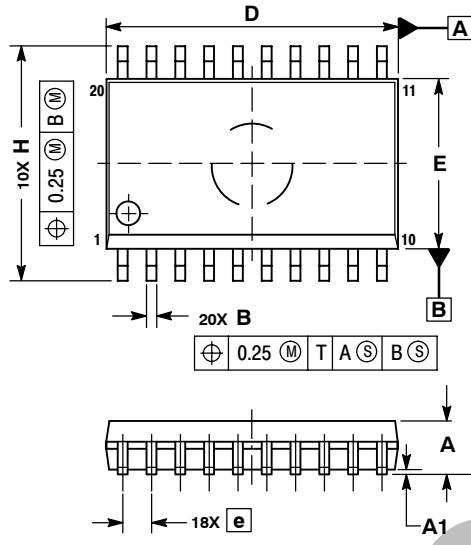

NOTES:

1. DIMENSIONS ARE IN MILLIMETERS.
2. INTERPRET DIMENSIONS AND TOLERANCES PER ASME Y14.5M, 1994.
3. DIMENSIONS D AND E DO NOT INCLUDE MOLD PROTRUSION.
4. MAXIMUM MOLD PROTRUSION 0.15 PER SIDE.
5. DIMENSION B DOES NOT INCLUDE DAMBAR PROTRUSION. ALLOWABLE PROTRUSION SHALL BE 0.13 TOTAL IN EXCESS OF B DIMENSION AT MAXIMUM MATERIAL CONDITION.

DIM	MILLIMETERS	
	MIN	MAX
A	2.35	2.65
A1	0.10	0.25
B	0.35	0.49
C	0.23	0.32
D	12.65	12.95
E	7.40	7.60
e	1.27 BSC	
H	10.05	10.55
h	0.25	0.75
L	0.50	0.90
θ	0°	7°

ON Semiconductor and are registered trademarks of Semiconductor Components Industries, LLC (SCILLC). SCILLC reserves the right to make changes without further notice to any products herein. SCILLC makes no warranty, representation or guarantee regarding the suitability of its products for any particular purpose, nor does SCILLC assume any liability arising out of the application or use of any product or circuit, and specifically disclaims any and all liability, including without limitation special, consequential or incidental damages. "Typical" parameters which may be provided in SCILLC data sheets and/or specifications can and do vary in different applications and actual performance may vary over time. All operating parameters, including "Typicals" must be validated for each customer application by customer's technical experts. SCILLC does not convey any license under its patent rights nor the rights of others. SCILLC products are not designed, intended, or authorized for use as components in systems intended for surgical implant into the body, or other applications intended to support or sustain life, or for any other application in which the failure of the SCILLC product could create a situation where personal injury or death may occur. Should Buyer purchase or use SCILLC products for any such unintended or unauthorized application, Buyer shall indemnify and hold SCILLC and its officers, employees, subsidiaries, affiliates, and distributors harmless against all claims, costs, damages, and expenses, and reasonable attorney fees arising out of, directly or indirectly, any claim of personal injury or death associated with such unintended or unauthorized use, even if such claim alleges that SCILLC was negligent regarding the design or manufacture of the part. SCILLC is an Equal Opportunity/Affirmative Action Employer. This literature is subject to all applicable copyright laws and is not for resale in any manner.

PUBLICATION ORDERING INFORMATION

LITERATURE FULFILLMENT:
 Literature Distribution Center for ON Semiconductor
 P.O. Box 5163, Denver, Colorado 80217 USA
Phone: 303-675-2175 or 800-344-3860 Toll Free USA/Canada
Fax: 303-675-2176 or 800-344-3867 Toll Free USA/Canada
Email: orderlit@onsemi.com

N. American Technical Support: 800-282-9855 Toll Free
 USA/Canada
Europe, Middle East and Africa Technical Support:
 Phone: 421 33 790 2910
Japan Customer Focus Center
 Phone: 81-3-5773-3850

ON Semiconductor Website: www.onsemi.com
Order Literature: <http://www.onsemi.com/orderlit>

For additional information, please contact your local Sales Representative

SN74LS682/D