

54AC280 9-Bit Parity Generator/Checker

General Description

The 'AC280 is a high-speed parity generator/checker that accepts nine bits of input data and detects whether an even or an odd number of these inputs is HIGH. If an even number of inputs is HIGH, the Sum Even output is HIGH. If an odd number is HIGH, the Sum Even output is LOW. The Sum Odd output is the complement of the Sum Even output.

Features

- I_{CC} reduced by 50%
- 9-bit width for memory applications
- Standard Microcircuit Drawing (SMD) 5962-92201

Logic Symbols

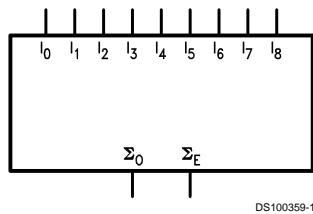

IEEE/IEC

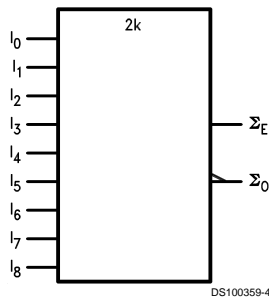

Pin Names	Description
I_0-I_8	Data Inputs
Σ_O	Odd Parity Output
Σ_E	Even Parity Output

Connection Diagrams

Pin Assignment for
DIP and Flatpak

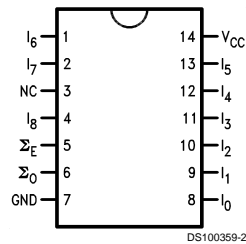

Pin Assignment for LCC

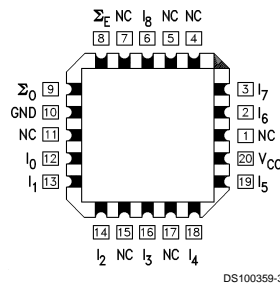

Truth Table

Number of HIGH Inputs I_0-I_8	Outputs	
	Σ Even	Σ Odd
0, 2, 4, 6, 8	H	L
1, 3, 5, 7, 9	L	H

H = HIGH Voltage Level
L = LOW Voltage Level

Logic Diagram

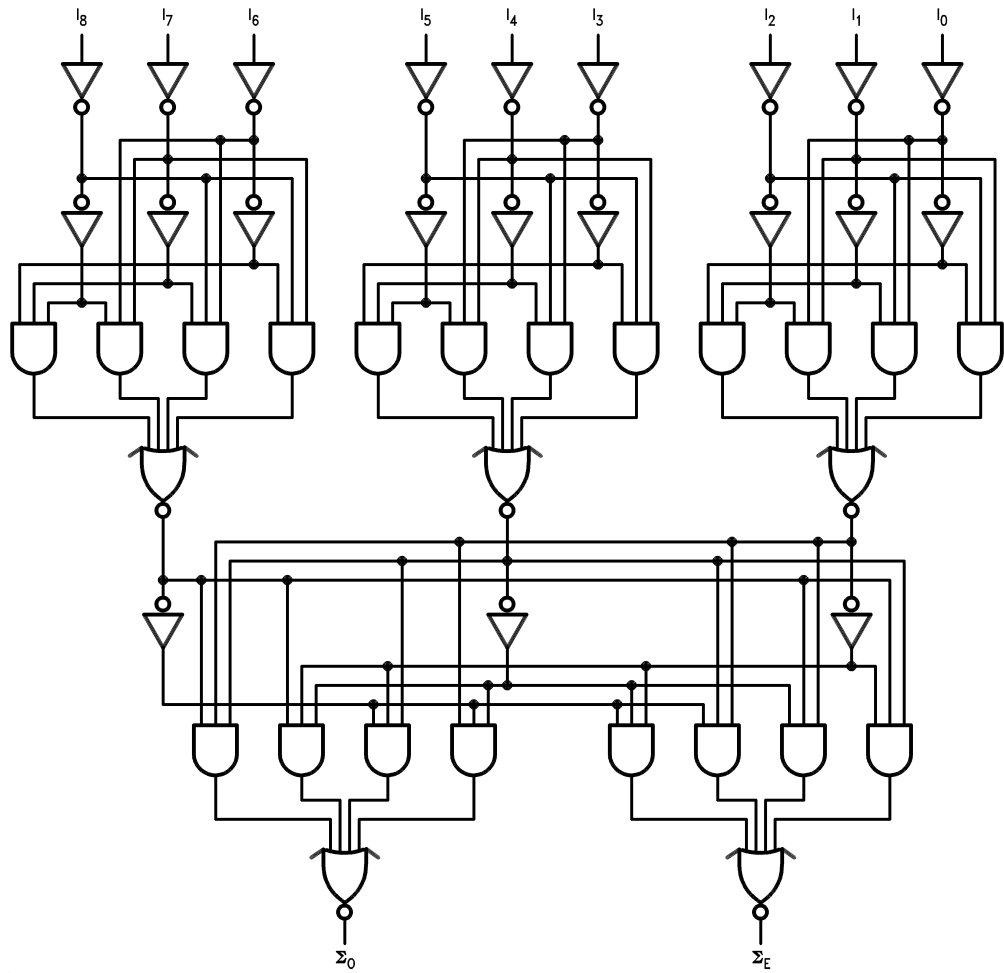

DS100359-5

Please note that this diagram is provided only for the understanding of logic operations and should not be used to estimate propagation delays.

Absolute Maximum Ratings (Note 1)

If Military/Aerospace specified devices are required, please contact the National Semiconductor Sales Office/Distributors for availability and specifications.

Supply Voltage (V_{CC})	-0.5V to +7.0V
DC Input Diode Current (I_{IK})	
$V_I = -0.5V$	-20 mA
$V_I = V_{CC} + 0.5V$	+20 mA
DC Input Voltage (V_I)	-0.5V to $V_{CC} + 0.5V$
DC Output Diode Current (I_{OK})	
$V_O = -0.5V$	-20 mA
$V_O = V_{CC} + 0.5V$	+20 mA
DC Output Voltage (V_O)	-0.5V to $V_{CC} + 0.5V$
DC Output Source or Sink Current (I_O)	±50 mA
DC V_{CC} or Ground Current per Output Pin (I_{CC} or I_{GND})	±50 mA
Storage Temperature (T_{STG})	-65°C to +150°C
Junction Temperature (T_J)	

CDIP

175°C

Recommended Operating Conditions

Supply Voltage (V_{CC})	'AC	2.0V to 6.0V
Input Voltage (V_I)		0V to V_{CC}
Output Voltage (V_O)		0V to V_{CC}
Operating Temperature (T_A)	54AC	-55°C to +125°C
Minimum Input Edge Rate ($\Delta V/\Delta t$)	'AC Devices	
	V_{IN} from 30% to 70% of V_{CC}	
	V_{CC} @ 3.3V, 4.5V, 5.5V	125 mV/ns

Note 1: Absolute maximum ratings are those values beyond which damage to the device may occur. The databook specifications should be met, without exception, to ensure that the system design is reliable over its power supply, temperature, output/input loading variables. National does not recommend operation of FACT circuits outside databook specifications.

DC Characteristics for 'AC Family Devices

Symbol	Parameter	V_{CC} (V)	54AC	Units	Conditions	
			$T_A =$ -55°C to +125°C			
			Guaranteed Limits			
V_{IH}	Minimum High Level Input Voltage	3.0	2.1	V	$V_{OUT} = 0.1V$ or $V_{CC} - 0.1V$	
		4.5	3.15			
		5.5	3.85			
V_{IL}	Maximum Low Level Input Voltage	3.0	0.9	V	$V_{OUT} = 0.1V$ or $V_{CC} - 0.1V$	
		4.5	1.35			
		5.5	1.65			
V_{OH}	Minimum High Level Output Voltage	3.0	2.9	V	$I_{OUT} = -50 \mu A$	
		4.5	4.4			
		5.5	5.4			
			3.0	2.4	V	(Note 2) $V_{IN} = V_{IL}$ or V_{IH} $I_{OH} = -12 \text{ mA}$ $I_{OH} = -24 \text{ mA}$ $I_{OH} = -24 \text{ mA}$
			4.5	3.7		
			5.5	4.7		
V_{OL}	Maximum Low Level Output Voltage	3.0	0.1	V	$I_{OUT} = 50 \mu A$	
		4.5	0.1			
		5.5	0.1			
			3.0	0.50	V	(Note 2) $V_{IN} = V_{IL}$ or V_{IH} $I_{OL} = 12 \text{ mA}$ $I_{OL} = 24 \text{ mA}$ $I_{OL} = 24 \text{ mA}$
			4.5	0.50		
			5.5	0.50		
I_{IN}	Maximum Input Leakage Current	5.5	±1.0	µA	$V_I = V_{CC}, GND$	
I_{OLD}	Minimum Dynamic Output Current (Note 3)	5.5	50	mA	$V_{OLD} = 1.65V \text{ Max}$	
I_{OHD}		5.5	-50	mA	$V_{OHD} = 3.85V \text{ Min}$	

DC Characteristics for 'AC Family Devices (Continued)

Symbol	Parameter	V _{CC} (V)	54AC		Units	Conditions
			T _A = -55°C to +125°C			
			Guaranteed Limits			
I _{CC}	Maximum Quiescent Supply Current	5.5	80.0		μA	V _{IN} = V _{CC} or GND

Note 2: All outputs loaded; thresholds on input associated with output under test.

Note 3: Maximum test duration 2.0 ms, one output loaded at a time.

Note 4: I_{IN} and I_{CC} @ 3.0V are guaranteed to be less than or equal to the respective limit @ 5.5V V_{CC}.

AC Electrical Characteristics

Symbol	Parameter	V _{CC} (V) (Note 5)	54AC		Units
			T _A = -55°C to +125°C C _L = 50 pF		
			Min	Max	
t _{PLH}	Propagation Delay	3.3	1.0	20.0	ns
t _{PHL}	I _n to Σ _E	5.0	1.0	14.5	
t _{PLH}	Propagation Delay	3.3	1.0	20.0	ns
t _{PHL}	I _n to Σ _O	5.0	1.0	14.5	

Note 5: Voltage range 3.3 is 3.3V ±0.3V.

Voltage range 5.0 is 5.0V ±0.5V.

Capacitance

Symbol	Parameter	Typ	Units	Conditions
C _{IN}	Input Capacitance	4.5	pF	V _{CC} = OPEN
C _{PD}	Power Dissipation Capacitance	75.0	pF	V _{CC} = 5.0V

Physical Dimensions inches (millimeters) unless otherwise noted

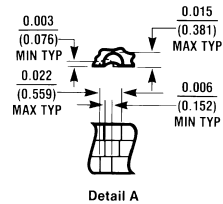
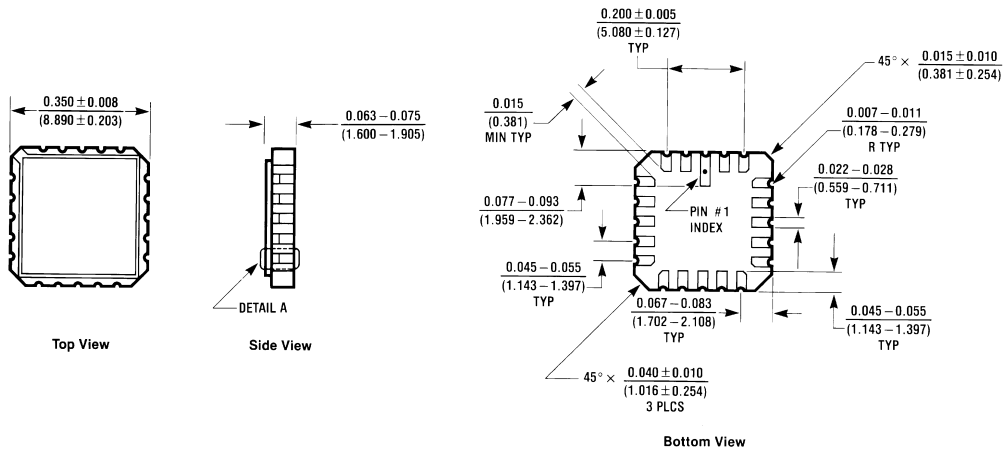

20 Terminal Ceramic Leadless Chip Carrier
NS Package Number E20A

E20A (REV D)

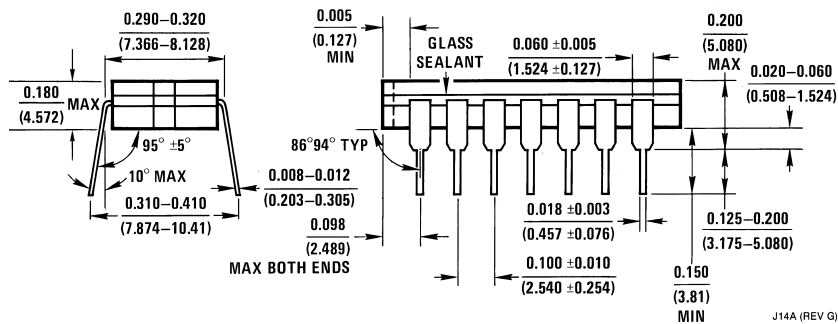
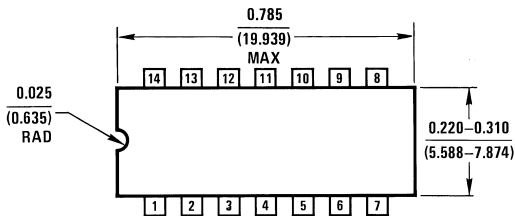

14 Lead Ceramic Dual-In-Line Package
NS Package Number J14A

J14A (REV G)

Physical Dimensions inches (millimeters) unless otherwise noted (Continued)

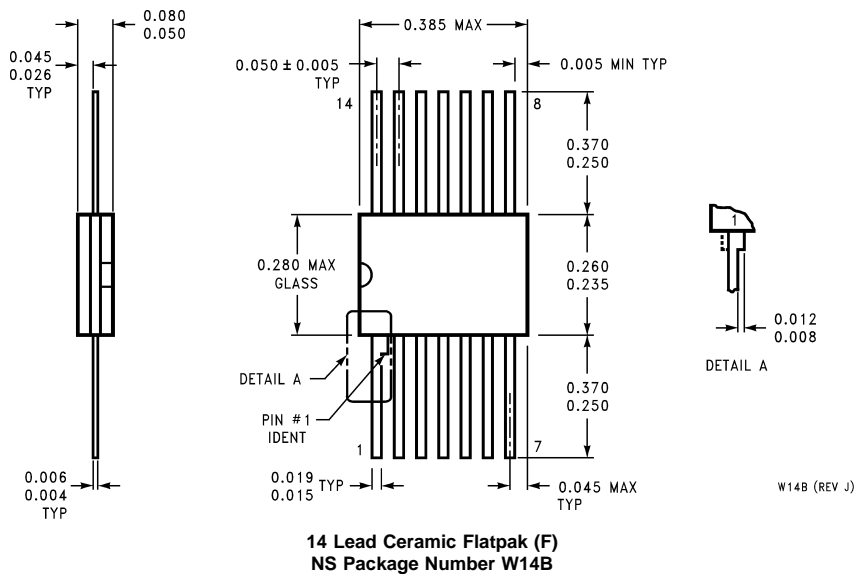

LIFE SUPPORT POLICY

NATIONAL'S PRODUCTS ARE NOT AUTHORIZED FOR USE AS CRITICAL COMPONENTS IN LIFE SUPPORT DEVICES OR SYSTEMS WITHOUT THE EXPRESS WRITTEN APPROVAL OF THE PRESIDENT OF NATIONAL SEMICONDUCTOR CORPORATION. As used herein:

1. Life support devices or systems are devices or systems which, (a) are intended for surgical implant into the body, or (b) support or sustain life, and whose failure to perform when properly used in accordance with instructions for use provided in the labeling, can be reasonably expected to result in a significant injury to the user.
2. A critical component in any component of a life support device or system whose failure to perform can be reasonably expected to cause the failure of the life support device or system, or to affect its safety or effectiveness.



National Semiconductor Corporation
Americas
Tel: 1-800-272-9959
Fax: 1-800-737-7018
Email: support@nsc.com

National Semiconductor Europe
Fax: +49 (0) 1 80-530 85 86
Email: europe.support@nsc.com
Deutsch Tel: +49 (0) 1 80-530 85 85
English Tel: +49 (0) 1 80-532 78 32
Français Tel: +49 (0) 1 80-532 93 58
Italiano Tel: +49 (0) 1 80-534 16 80

National Semiconductor Asia Pacific Customer Response Group
Tel: 65-2544466
Fax: 65-2504466
Email: sea.support@nsc.com

National Semiconductor Japan Ltd.
Tel: 81-3-5620-6175
Fax: 81-3-5620-6179

www.national.com

National does not assume any responsibility for use of any circuitry described, no circuit patent licenses are implied and National reserves the right at any time without notice to change said circuitry and specifications.