

Features

- CMOS for optimum speed/power
- High speed
 - 25 ns (Commercial)
- Low power
 - 495 mW (Commercial)
- EPROM technology 100% programmable
- Slim 300-mil or standard 600-mil DIP or 28-pin LCC
- 5V ±10% V_{CC}, commercial and military
- TTL-compatible I/O
- Direct replacement for bipolar PROMs
- Capable of withstanding >2001V static discharge

Functional Description

The CY7C281A is a high-performance 1024-word by 8-bit CMOS PROMs. It is packaged in 300-mil and 600-mil-wide

packages respectively. The CY7C281A is also available in a 28-pin leadless chip carrier. The memory cells utilize proven EPROM floating-gate technology and byte-wide intelligent programming algorithms.

The CY7C281A is a plug-in replacements for bipolar devices and offer the advantages of lower power, superior performance, and programming yield. The EPROM cell requires only 12.5V for the super voltage, and low current requirements allow for gang programming. The EPROM cells allow each memory location to be tested 100% because each location is written into, erased, and repeatedly exercised prior to encapsulation. Each PROM is also tested for AC performance to guarantee that after customer programming, the product will meet DC and AC specification limits.

Reading is accomplished by placing an active LOW signal on CS₁ and CS₂, and active HIGH signals on CS₃ and CS₄. The contents of the memory location addressed by the address lines (A₀–A₉) will become available on the output lines (O₀–O₇).

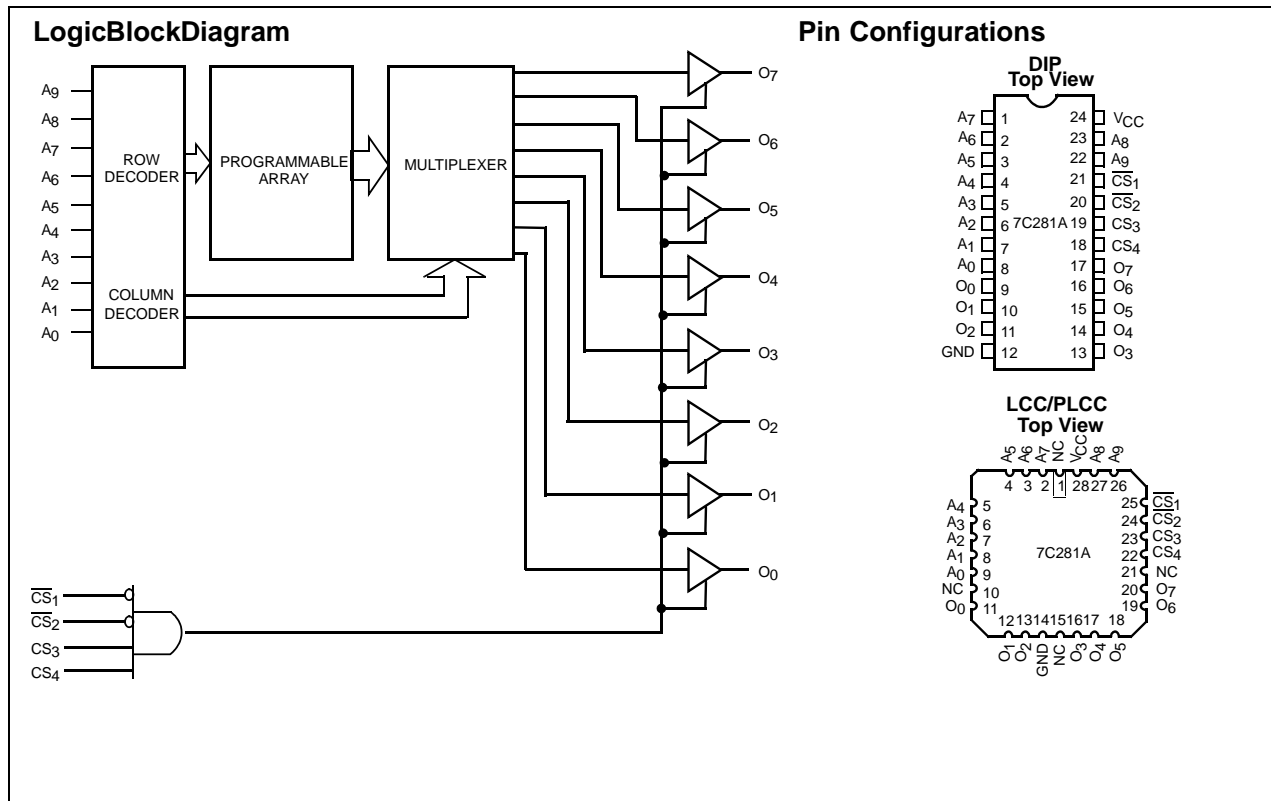

Selection Guide

		7C281A-25	7C281A-30	Unit
Maximum Access Time		25	30	ns
Maximum Operating Current	Commercial	100	100	mA

Maximum Ratings^[1]

(Above which the useful life may be impaired. For user guidelines, not tested.)

Storage Temperature -65°C to +150°C

Ambient Temperature with Power Applied..... -55°C to +125°C

Supply Voltage to Ground Potential (Pin 24 to Pin 12)..... -0.5V to +7.0V

DC Voltage Applied to Outputs in High Z State -0.5V to +7.0V

DC Input Voltage -3.0V to +7.0V

DC Program Voltage (Pins 18, 20) 13.0V

Static Discharge Voltage..... >2001V (per MIL-STD-883, Method 3015)

Latch-Up Current..... >200 mA

Operating Range

Range	Ambient Temperature	V _{CC}
Commercial	0°C to +70°C	5V ±10%

Electrical Characteristics Over the Operating Range^[2,3]

Parameter	Description	Test Conditions	7C281A-25		7C281A-30		Unit
			Min.	Max.	Min.	Max.	
V _{OH}	Output HIGH Voltage	V _{CC} = Min., I _{OH} = -4.0 mA	2.4		2.4		V
V _{OL}	Output LOW Voltage	V _{CC} = Min., I _{OL} = 16.0 mA		0.4		0.4	V
V _{IH}	Input HIGH Level	Guaranteed Input Logical HIGH Voltage for All Inputs	2.0		2.0		V
V _{IL}	Input LOW Level	Guaranteed Input Logical LOW Voltage for All Inputs		0.8		0.8	V
I _{Ix}	Input Current	GND ≤ V _{IN} ≤ V _{CC}	-10	+10	-10	+10	μA
I _{OZ}	Output Leakage Current	GND ≤ V _{OUT} ≤ V _{CC} , Output Disabled	-10	+10	-10	+10	μA
I _{OS}	Output Short Circuit Current ^[4]	V _{CC} = Max., V _{OUT} = GND	-20	-90	-20	-90	mA
I _{CC}	Power Supply Current	V _{CC} = Max., I _{OUT} = 0 mA		100		100	mA
V _{PP}	Program Voltage		12	13	12	13	V
V _{IHP}	Program HIGH Voltage		3.0		3.0		V
V _{ILP}	Program LOW Voltage			0.4		0.4	V
I _{PP}	Program Supply Current			50		50	mA

Capacitance^[3]

Parameter	Description	Test Conditions	Max.	Unit
C _{IN}	Input Capacitance	T _A = 25°C, f = 1 MHz, V _{CC} = 5.0V	10	pF
C _{OUT}	Output Capacitance		10	pF

Notes

1. The voltage on any input or I/O pin cannot exceed the power pin during power-up.
2. See the last page of this specification for Group A subgroup testing information.
3. See "Introduction to CMOS PROMs" in this Data Book for general information on testing.
4. For test purposes, not more than one output at a time should be shorted. Short circuit test duration should not exceed 30 seconds.

AC Test Loads and Waveforms^[3]

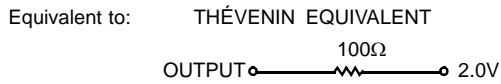
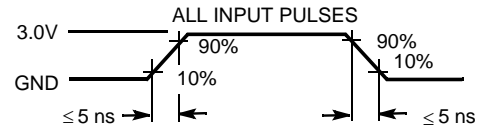
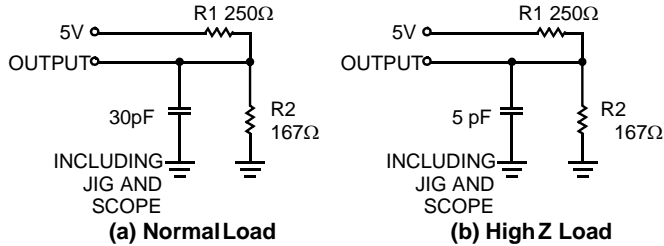

Switching Characteristics Over the Operating Range^[1,3]

Parameter	Description	7C281A-25		7C281A-30		Unit
		Min.	Max.	Min.	Max.	
t _{AA}	Address to Output Valid		25		30	ns
t _{HZCS}	Chip Select Inactive to High Z		15		20	ns
t _{ACS}	Chip Select Active to Output Valid		15		20	ns

Switching Waveforms

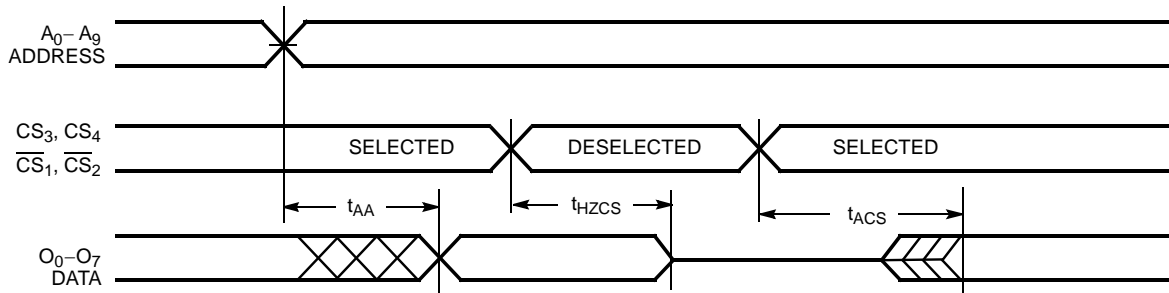

Programming Information

Programming support is available from Cypress as well as from a number of third party software vendors. For detailed

programming information, including a listing of software packages, please see the PROM Programming Information located at the end of this section. Programming algorithms can be obtained from any Cypress representative.

Table 1. Mode Selection

Mode	Pin Function ^[5]						
	Read or Output Disable	A ₉ -A ₀	CS ₄	CS ₃	CS ₂	CS ₁	O ₇ -O ₀
	Other	A ₉ -A ₀	PGM	VFY	V _{PP}	CS ₁	D ₇ -D ₀
Read		A ₉ -A ₀	V _{IH}	V _{IH}	V _{IL}	V _{IL}	O ₇ -O ₀
Output Disable		A ₉ -A ₀	X	X	V _{IH}	X	High Z
Output Disable		A ₉ -A ₀	X	V _{IL}	X	X	High Z
Output Disable		A ₉ -A ₀	V _{IL}	X	X	X	High Z
Output Disable		A ₉ -A ₀	X	X	X	V _{IH}	High Z
Program		A ₉ -A ₀	V _{ILP}	V _{IHP}	V _{PP}	V _{ILP}	D ₇ -D ₀
Program Verify		A ₉ -A ₀	V _{IHP}	V _{ILP}	V _{PP}	V _{ILP}	O ₇ -O ₀
Program Inhibit		A ₉ -A ₀	V _{IHP}	V _{IHP}	V _{PP}	V _{ILP}	High Z
Intelligent Program		A ₉ -A ₀	V _{ILP}	V _{IHP}	V _{PP}	V _{ILP}	D ₇ -D ₀
Blank Check		A ₉ -A ₀	V _{IHP}	V _{ILP}	V _{PP}	V _{ILP}	Zeros

Figure 1. Programming Pinouts

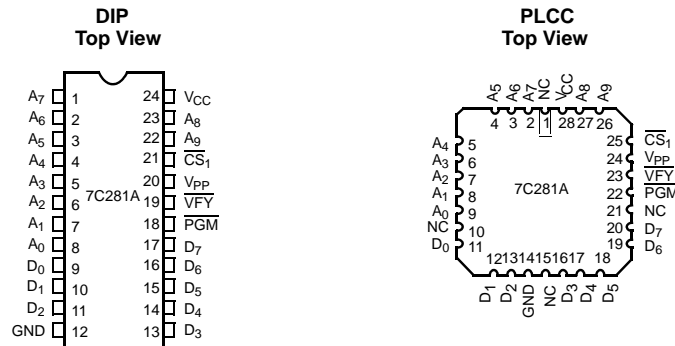

Note
5. X = "don't care" but not to exceed V_{CC} ±5%.

Typical DC and AC Characteristics

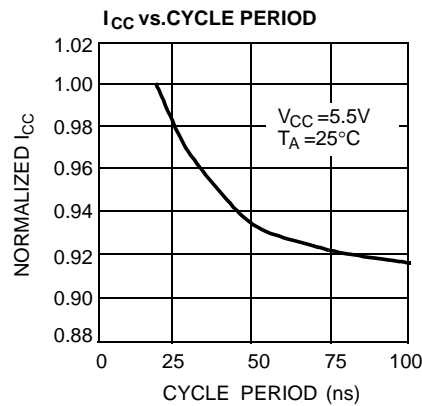
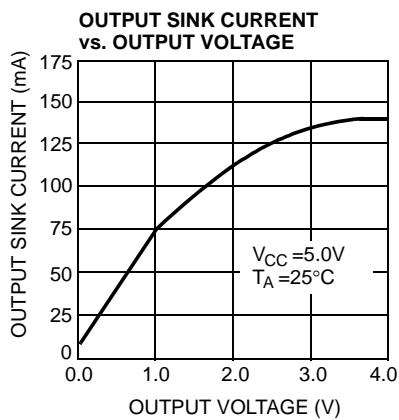
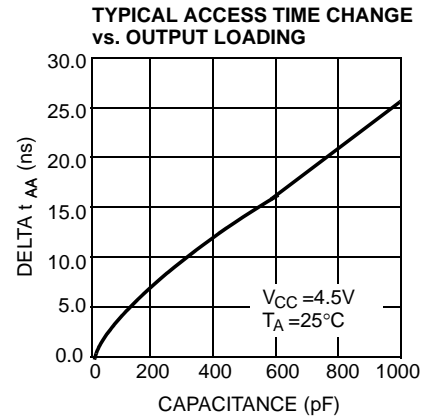
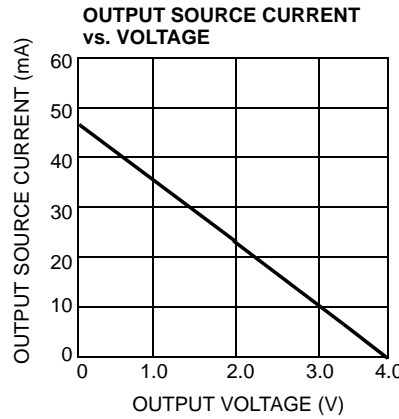
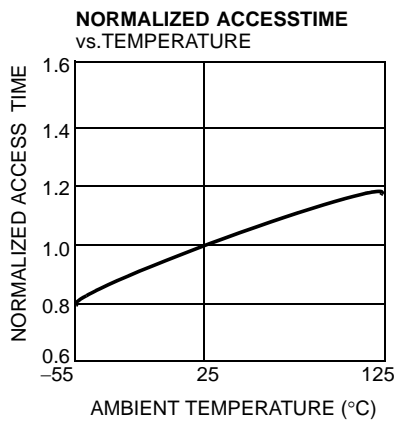
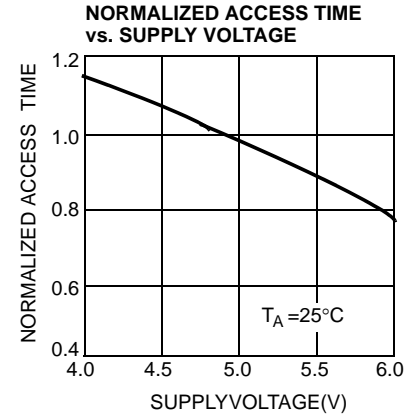
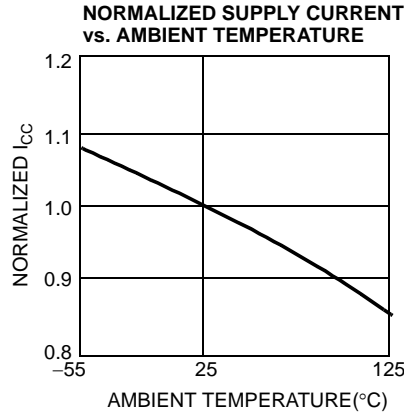
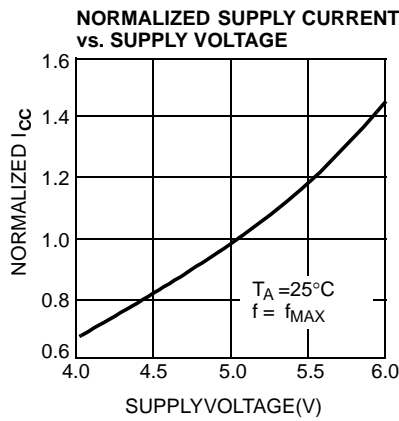

Ordering Information

Speed (ns)	Ordering Code	Package Name	Package Type	Operating Range
25	CY7C281A-25JC	J64	28-Lead Plastic Leaded Chip Carrier	Commercial
30	CY7C281A-30PC	P13	24-Lead (300-Mil) Molded DIP	Commercial

Package Diagrams

Figure 2. 28-Lead Plastic Leaded Chip Carrier J64

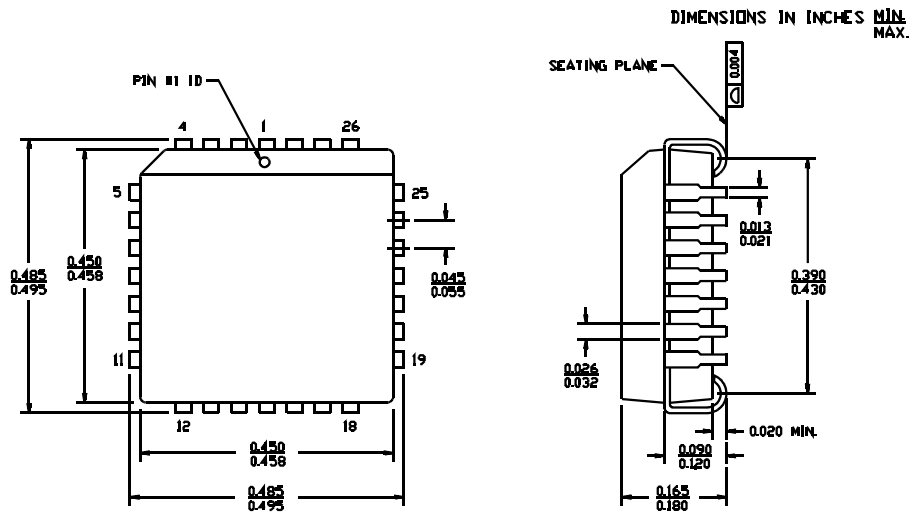

51-85001-*A

Package Diagrams

Figure 3. 24-Lead (300-Mil) PDIP P13

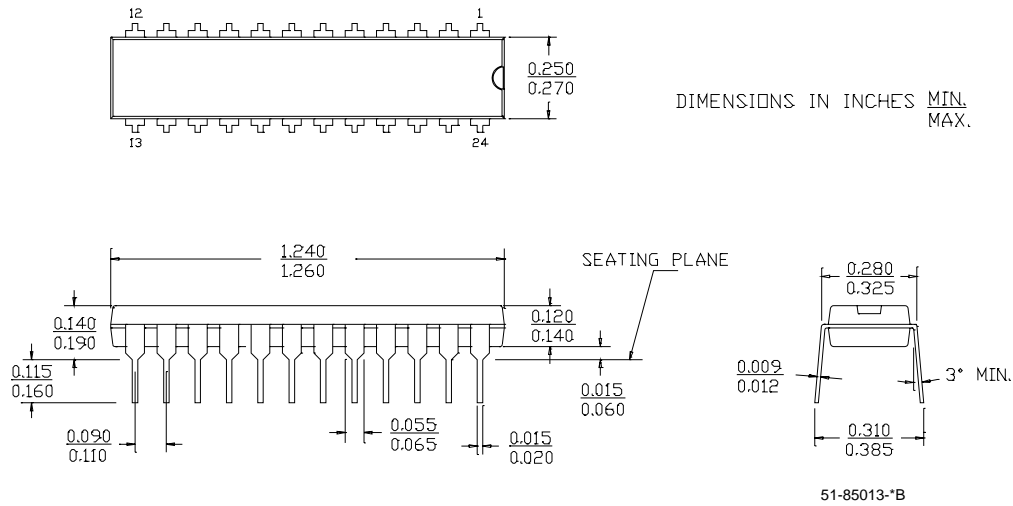

All product and company names mentioned in this document may be the trademarks of their respective holders.

Document History Page

Document Title: CY7C281A 1K x 8 PROM Document Number: 38-04003				
REV.	ECN NO.	Issue Date	Orig. of Change	Description of Change
**	113859	03/06/02	DSG	Changed from Spec number: 38-00227 to 38-04003
*A	118902	10/09/02	GBI	Updated ordering information
*B	122244	12/27/02	RBI	Added power up requirements to Maximum ratings information
*C	499538	See ECN	PCI	Updated ordering information