

## General-purpose Threaded Sensor That Detects Metals and Non-metals Alike





- Detects both metallic and nonmetallic objects (water, oil, glass, plastic, etc.).
- Three choices of threaded cylinder sizes for easy installation: M12, M18, and M30.
- Fixed sensing distance requires no sensitivity adjustment.



 Be sure to read *Safety Precautions* on page 5.

## Ordering Information

### Sensors

Appearance	Sensing distance	Output configuration	Model	
			Operation mode	
			NO	NC
Unshielded 	M12  4 mm	DC 3-wire, NPN	E2K-X4ME1	E2K-X4ME2
		AC 2-wire	E2K-X4MY1	E2K-X4MY2
	M18  8 mm	DC 3-wire, NPN	E2K-X8ME1	E2K-X8ME2
		AC 2-wire	E2K-X8MY1	E2K-X8MY2
	M30  15 mm	DC 3-wire, NPN	E2K-X15ME1	E2K-X15ME2
		AC 2-wire	E2K-X15MY1	E2K-X15MY2

### Accessories (Order Separately)

#### Mounting Brackets

## Ratings and Specifications

Item	Model	E2K-X4ME□, E2K-X4MY□	E2K-X8ME□, E2K-X8MY□	E2K-X15ME□, E2K-X15MY□
Sensing distance		4mm ±10%	8 mm ±10%	15 mm ±10%
Set distance *1		0 to 2.8 mm	0 to 5.6 mm	0 to 10 mm
Differential travel		4% to 20% of sensing distance		
Detectable object		Conductors and dielectrics		
Standard sensing object		Grounded metal plate: 50 × 50 × 1 mm		
Response frequency		E Models: 100 Hz, Y Models: 10 Hz		
Power supply voltage*2 (operating voltage range)		E Models: 12 to 24 VDC (10 to 30 VDC) Y Models: 100 to 220 VAC (90 to 250 VAC)		
Current consumption		E Models: 15 mA max.		
Leakage current		Y Models: 2.2 mA max. (Refer to page 4.)		
Control output	Load current	E Models: 200 mA max.*2, Y Models: 10 to 200 mA		
	Residual voltage	E Models: 1 V max. (Load current: 200 mA, Cable length: 2 m), Y Models: Refer to <i>Engineering Data</i> on page 4.		
Indicators		E Models: Detection indicator (red), Y Models: Operation indicator (red)		
Operation mode (with sensing object approaching)		E1/Y1 Models: NO E2/Y2 Models: NC Refer to the timing charts under <i>I/O Circuit Diagrams</i> on page 4 for details.		
Protection circuits		E Models: Reverse polarity protection, Surge suppressor, Y Models: Surge suppressor		
Ambient temperature range		Operating/Storage: -25 to 70°C (with no icing or condensation)		Operating/Storage: -10 to 55°C (with no icing or condensation)
Ambient humidity range		Operating/Storage: 35% to 95% (with no condensation)		
Temperature influence		±20% max. of sensing distance at 23°C in the operating temperature range		
Voltage influence		E Models: ±2% max. of sensing distance at rated voltage at rated voltage ±20% Y Models: ±2% max. of sensing distance at rated voltage at rated voltage ±10%		
Insulation resistance		50 MΩ min. (at 500 VDC) between current-carrying parts and case		
Dielectric strength		E Models: 1,000 VAC, 50/60 Hz for 1 min between current-carrying parts and case Y Models: 2,000 VAC, 50/60 Hz for 1 min between current-carrying parts and case		
Vibration resistance		Destruction: 10 to 55 Hz, 1.5-mm double amplitude for 2 hours each in X, Y, and Z directions		
Shock resistance		Destruction: 500 m/s <sup>2</sup> 3 times each in X, Y, and Z directions		
Degree of protection		IP66 (IEC), in-house standards: oil-resistant		
Connection method		Pre-wired Models (Standard cable length: 2 m)		
Weight (packed state)		Approx. 65 g	Approx. 145 g	Approx. 205 g
Materi- als	Case	Heat-resistant ABS		
	Sensing surface			
	Clamping nuts			
Accessories		Tightening tool, Instruction Manual	Instruction manual	

\*1. The above values are sensing distances for the standard sensing object. Refer to *Engineering Data* on page 3 for other materials.

\*2. E Models (DC switching models): A full-wave rectification power supply of 24 VDC ±20% (average value) can be used.

# Engineering Data (Typical)

## Sensing Area (Grounded Metal Plate)

### E2K-X4M

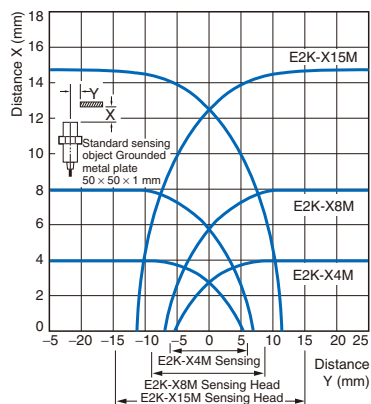

## Influence of Sensing Object Size and Material

### E2K-X4M

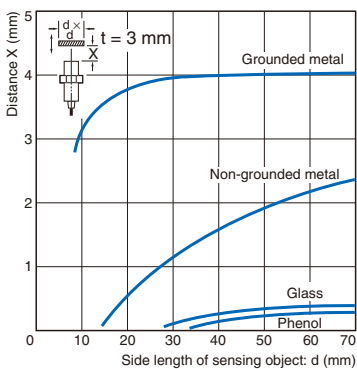

### E2K-X8M

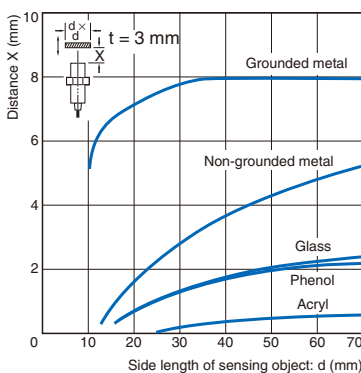

### E2K-X15M

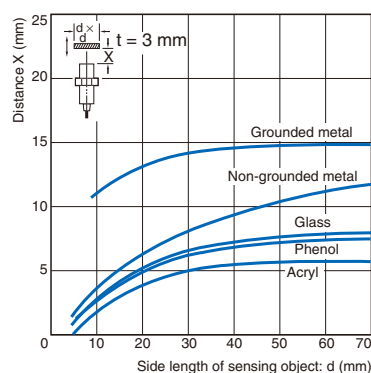

## Sensing Object Thickness and Material vs. Sensing Distance

### E2K-X4M

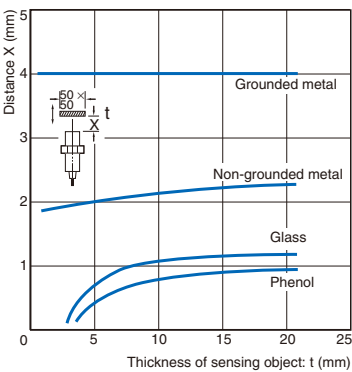

### E2K-X8M

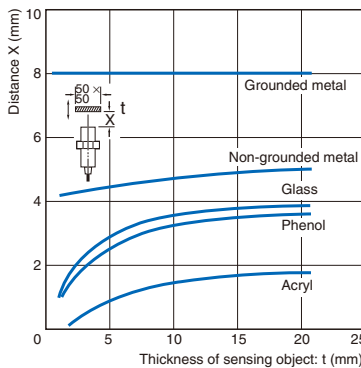

### E2K-X15M

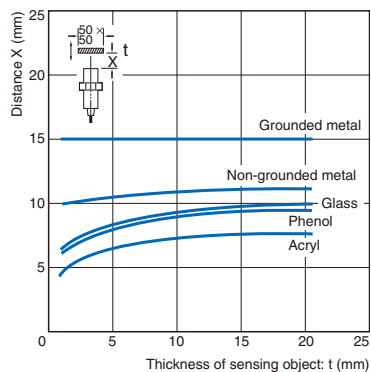

## Leakage Current

E2K-X□MY

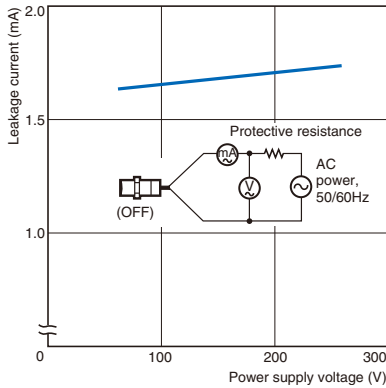

## Residual Output Voltage

E2K-X□MY□

at 100 VAC

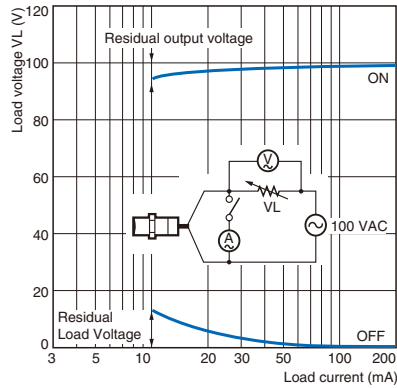

E2K-X□MY□

at 200 VAC

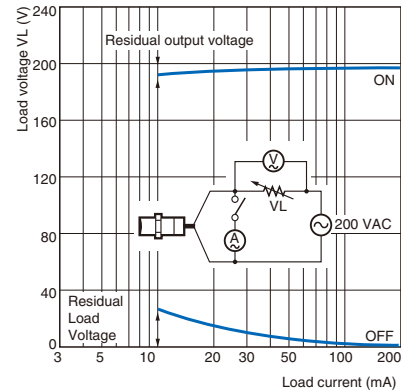

## I/O Circuit Diagrams

### DC 3-Wire Models

Operation mode	Model	Timing chart	Output circuit
NO	E2K-X4ME1 E2K-X8ME1 E2K-X15ME1	<p>Sensing object</p> <p>Present</p> <p>Not present</p> <p>Operate</p> <p>Reset</p> <p>Output voltage (between black and blue leads)</p> <p>High</p> <p>Low</p> <p>Detection indicator (red)</p> <p>ON</p> <p>OFF</p>	<p>*1. Load current: 200 mA max. *2. When a transistor is connected.</p>
NC	E2K-X4ME2 E2K-X8ME2 E2K-X15ME2	<p>Sensing object</p> <p>Present</p> <p>Not present</p> <p>Operate</p> <p>Reset</p> <p>Output voltage (between black and blue leads)</p> <p>High</p> <p>Low</p> <p>Detection indicator (red)</p> <p>ON</p> <p>OFF</p>	

### AC 2-Wire Models

Operation mode	Model	Timing chart	Output circuit
NO	E2K-X4MY1 E2K-X8MY1 E2K-X15MY1	<p>Sensing object</p> <p>Present</p> <p>Not present</p> <p>Operate</p> <p>Reset</p> <p>Operation indicator (red)</p> <p>ON</p> <p>OFF</p>	
NC	E2K-X4MY2 E2K-X8MY2 E2K-X15MY2	<p>Sensing object</p> <p>Present</p> <p>Not present</p> <p>Operate</p> <p>Reset</p> <p>Operation indicator (red)</p> <p>ON</p> <p>OFF</p>	

## Safety Precautions

Refer to *Warranty and Limitations of Liability*.

**⚠ WARNING**

This product is not designed or rated for ensuring safety of persons either directly or indirectly. Do not use it for such purposes.

**Precautions for Correct Use**

Do not use this product under ambient conditions that exceed the ratings.

● **Design**

**Ambient Environment**

The Sensor may malfunction if subjected to water, oil, chemicals, or condensation by falsely detecting these as sensing objects. The E2K-X15M is highly sensitive to inductive objects and can thus be affected even by small quantities of water drops.

**Influence of Surrounding Objects**

If the Sensor is embedded in metal, maintain at least the following distances between the Sensor and the metal. The Sensor is also affected by other materials, such as resins. Separate the Sensor from other materials by the same distance as for metal.

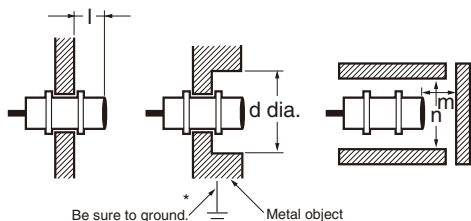

\* Be sure to ground the metal object, otherwise Sensor operation will not be stable.

**Influence of Surrounding Metal** (Unit: mm)

Model	Dimension	l	d	m	n
E2K-X4M	20	50	12	8	60
E2K-X8M				12	
E2K-X15M	10		25		

If a mounting bracket is used, be sure that at least the following distances are maintained.

**Influence of Surrounding Metal** (Unit: mm)

Model	Dimension	G	H
E2K-X4M	20	30	30
E2K-X8M			
E2K-X15M	10		

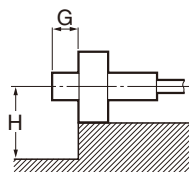

**Mutual Interference**

When installing Sensors face-to-face or side-by-side, ensure that the minimum distances given in the following table are maintained.

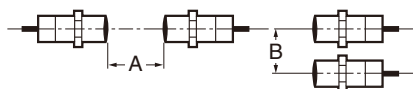

**Mutual Interference** (Unit: mm)

Model	Dimension	A	B
E2K-X4M		80	70
E2K-X8M		150	110
E2K-X15M		300	200

**Sensing Objects**

The maximum sensing distance will decrease if the sensing object is a non-grounded metal object or dielectric object.

- Sensing Object Material  
The E2K-X can detect almost any type of object. The sensing distance of the E2K-X, however, will vary with the electrical characteristics of the object, such as the conductance and inductance of the object, and the water content and capacity of the object. The maximum sensing distance of the E2K-X will be obtained if the object is made of grounded metal.
- There are objects that cannot be detected indirectly. Therefore, be sure to test the E2K-X in a trial operation with the objects before using the E2K-X in actual applications.

**Effects of a High-frequency Electromagnetic Field**

The E2K-X may malfunction if there is an ultrasonic washer, high-frequency generator, transceiver, or inverter nearby. For major measures, refer to *Noise of Warranty and Limitations of Liability* for Photoelectric Sensors.

**Mounting**

Do not tighten the nut with excessive force. Always use washers when tightening the nuts and do not exceed the torque in the following table.

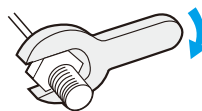

Model	Torque
E2K-X4M	0.78 N·m
E2K-X8M	2 N·m
E2K-X15M	

Note: A special tightening tool is provided with the E2K-X4M. Always use this tool to tighten the nuts.

● **Miscellaneous**

**Organic Solvents**

The Sensor has a case made of heat-resistant ABS resin. Be sure that the case is free from organic solvents or solutions containing organic solvents.

## Dimensions

E2K-X4ME□  
E2K-X4MY□

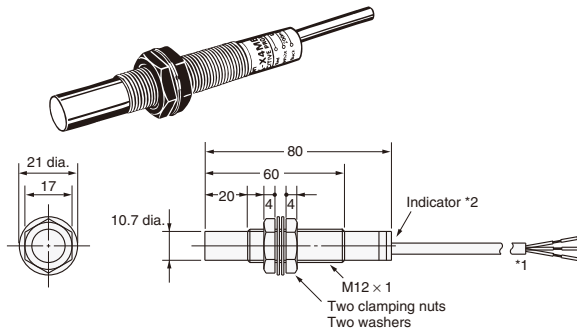

- \*1. E Models: 4-dia. vinyl-insulated round cable with 3 conductors (Conductor cross section: 0.2 mm<sup>2</sup>, Insulator diameter: 1.2 mm), Standard length: 2 m
- Y Models: 4-dia. vinyl-insulated round cable with 2 conductors (Conductor cross section: 0.3 mm<sup>2</sup>, Insulator diameter: 1.3 mm), Standard length: 2 m
- \*2. E Models: Detection indicator (red)
- Y Models: Operation indicator (red)

E2K-X8ME□  
E2K-X8MY□

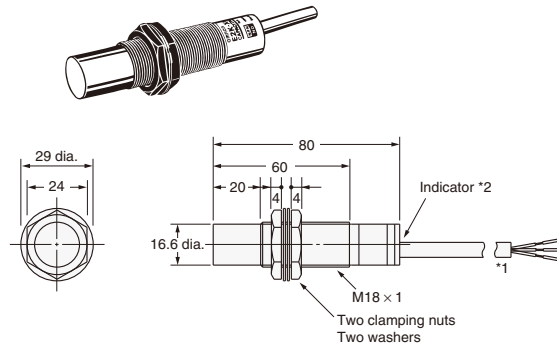

- \*1. E Models: 6-dia. vinyl-insulated round cable with 3 conductors (Conductor cross section: 0.5 mm<sup>2</sup>, Insulator diameter: 1.9 mm), Standard length: 2 m
- Y Models: 6-dia. vinyl-insulated round cable with 2 conductors (Conductor cross section: 0.5 mm<sup>2</sup>, Insulator diameter: 1.9 mm), Standard length: 2 m
- \*2. E Models: Detection indicator (red)
- Y Models: Operation indicator (red)

E2K-X15ME□  
E2K-X15MY□

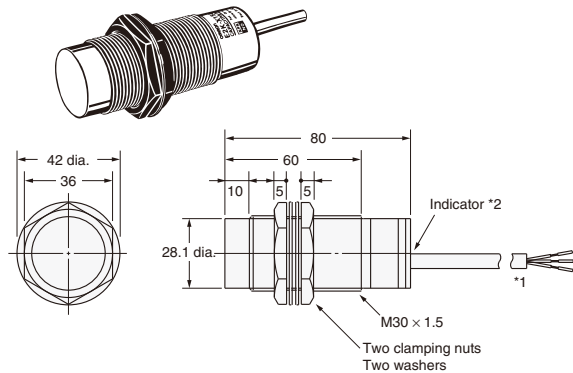

- \*1. E Models: 6-dia. vinyl-insulated round cable with 3 conductors (Conductor cross section: 0.5 mm<sup>2</sup>, Insulator diameter: 1.9 mm), Standard length: 2 m
- Y Models: 6-dia. vinyl-insulated round cable with 2 conductors (Conductor cross section: 0.5 mm<sup>2</sup>, Insulator diameter: 1.9 mm), Standard length: 2 m
- \*2. E Models: Detection indicator (red)
- Y Models: Operation indicator (red)

## Mounting Hole Dimensions

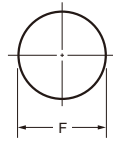

Model	F (mm)
E2K-X4ME□ E2K-X4MY□	12.5 <sup>+0.5</sup> <sub>0</sub> dia.
E2K-X8ME□ E2K-X8MY□	18.5 <sup>+0.5</sup> <sub>0</sub> dia.
E2K-X15ME□ E2K-X15MY□	30.5 <sup>+0.5</sup> <sub>0</sub> dia.

# Proximity Sensors Technical Guide

**General Precautions** For precautions on individual products, refer to the *Safety Precautions* in individual product information.

## ⚠ WARNING

These products cannot be used in safety devices for presses or other safety devices used to protect human life.



These products are designed for use in applications for sensing workpieces and workers that do not affect safety.

## Precautions for Safe Use

To ensure safety, always observe the following precautions.

### ●Wiring Considerations

Item	Typical examples	
<p><b>Power Supply Voltage</b></p> <p>Do not use a voltage that exceeds the operating voltage range. Applying a voltage that is higher than the operating voltage range, or using an AC power supply (100 VAC or higher) for a Sensor that requires a DC power supply may cause explosion or burning.</p>	<p>DC 3-Wire NPN Output Sensors</p>	<p>DC 2-Wire Sensors</p>
<p><b>Load short-circuiting</b></p> <ul style="list-style-type: none"> <li>Do not short-circuit the load. Explosion or burning may result.</li> <li>The load short-circuit protection function operates when the power supply is connected with the correct polarity and the power is within the rated voltage range.</li> </ul>	<p>DC 3-Wire NPN Output Sensors</p>	<ul style="list-style-type: none"> <li>DC 2-Wire Sensors</li> <li>Even with the load short-circuit protection function, protection will not be provided when a load short circuit occurs if the power supply polarity is not correct.</li> </ul>
<p><b>Incorrect Wiring</b></p> <p>Be sure that the power supply polarity and other wiring is correct. Incorrect wiring may cause explosion or burning.</p>	<p>DC 3-Wire NPN Output Sensors</p>	
<p><b>Connection without a Load</b></p> <p>If the power supply is connected directly without a load, the internal elements may explode or burn. Be sure to insert a load when connecting the power supply.</p>	<ul style="list-style-type: none"> <li>DC 2-Wire Sensors</li> <li>Even with the load short-circuit protection function, protection will not be provided if both the power supply polarity is incorrect and no load is connected.</li> </ul>	<p>AC 2-Wire Sensors</p>

### ●Operating Environment

Do not use the Sensor in an environment where there are explosive or combustible gases.

# Proximity Sensors Technical Guide

## Precautions for Correct Use

The following conditions must be considered to understand the conditions of the application and location as well as the relation to control equipment.

### ●Model Selection

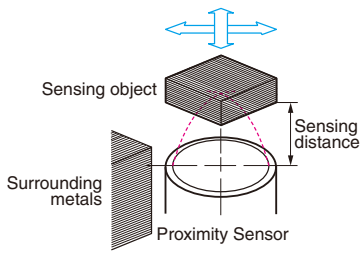
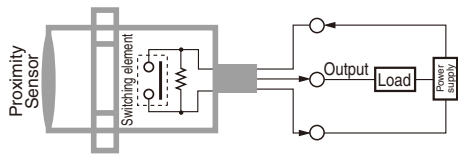
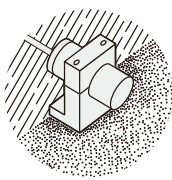
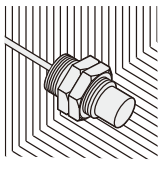
Item	Points of consideration				
<p>Sensing object and operating condition of Proximity Sensor</p> 	<p>Check the relation between the sensing object and the Proximity Sensor.</p>	<p>Specific conditions of object</p> <p>Material, size, shape, existence of plating, etc.</p>	<p>Direction of object movement</p> <p>Transit interval, speed, existence of vibration, etc.</p>	<p>Peripheral metal</p> <p>Material, distance to Sensor, orientation, etc.</p>	<p>Sensing distance</p> <p>Fluctuation in transit point, allowable error, etc.</p>
	<p>Sensing (set) distance, shape of Sensor (rectangular, cylindrical, through-beam, grooved), influence of peripheral metal (Shielded Sensors, Non-shielded Sensors), response speed (response frequency), influence of temperature, influence of voltage, etc.</p>				
<p>Electrical conditions</p> 	<p>Verify the electrical conditions of the control system to be used and the electrical performance of the Proximity Sensor.</p>	<p>Power supply</p> <ul style="list-style-type: none"> <li>DC (voltage fluctuation, current capacity value)</li> <li>AC (voltage fluctuation, frequency, etc.)</li> <li>Need for S3D2 Controller</li> </ul>	<p>Load</p> <ul style="list-style-type: none"> <li>Resistive load - Non-contact control system</li> <li>Inductive load - Relay, solenoid, etc.                             <ul style="list-style-type: none"> <li>Steady-state current, inrush current</li> <li>Operating, reset voltage (current)</li> </ul> </li> <li>Lamp load                             <ul style="list-style-type: none"> <li>Steady-state current, inrush current</li> </ul> </li> <li>Open/close frequency</li> </ul>	<p>Selecting the power supply type</p> <ul style="list-style-type: none"> <li>DC</li> <li>DC + S3D2 Controller</li> <li>AC</li> </ul>	<p>Selecting the power supply type</p> <ul style="list-style-type: none"> <li>DC</li> <li>DC + S3D2 Controller</li> <li>AC</li> </ul> <p>Control output</p> <ul style="list-style-type: none"> <li>Maximum current (voltage)</li> <li>Leakage current</li> <li>Residual load voltage</li> </ul>
<p>Environmental conditions</p> 	<p>The environmental tolerance of the Proximity Sensor is better than that of other types of Sensors. However, investigate carefully before using a Proximity Sensor under harsh temperatures or in special atmospheres.</p>	<p>Temperature and humidity</p> <p>Highest or lowest values, existence of direct sunlight, etc.</p>	<p>Temperature influence</p> <p>high-temperature use, low temperature use, need for shade, etc.</p>	<p>Water Resistance</p> <p>Do not use the Sensor in water, rain, or outdoors.</p>	<p>Ambient Conditions</p> <p>To maintain reliability of operation, do not use the Sensor outside the specified temperature range or outdoors. Even though the Proximity Sensor has a water-resistant structure, it must be covered to prevent direct contact with water or water-soluble cutting oil. Do not use the Sensor in atmospheres with chemical vapors, in particular, strong alkalis or acids (nitric acid, chromic acid, or hot concentrated sulfuric acid).</p>
	<p>Atmosphere</p> <p>Water, oil, iron powder, or other special chemicals</p>	<p>Need for water resistance or oil resistance, need for explosion-proof structure</p>		<p>Explosive Atmospheres</p> <p>Do not use the Sensor in atmospheres where there is a danger of explosion. Use an Explosion-proof Sensor.</p>	
<p>Mounting conditions</p> 	<p>When deciding the mounting method, take into consideration not only restrictions due to mechanical devices, but also ease of maintenance and inspection, and interference between Sensors.</p>	<p>Wiring method, existence of inductance surges</p> <p>Wires</p> <p>Wire type, length, oil-resistant cable, shielded cable, robot cable, etc.</p>	<p>Mounting procedure</p> <p>Existence of mounting brackets, direct mounting, secured with bolts or screws</p>	<p>Installation location</p> <p>Ease of maintenance and inspection, mounting space</p>	
<p>Influence of external electromagnetic fields</p>	<ul style="list-style-type: none"> <li>The influence within a DC magnetic field is 20 mT* max. Do not use the Sensor at a level higher than 20 mT.</li> <li>Sudden changes in the DC magnetic field may cause malfunction. Do not use the Sensor for applications that involve turning a DC electromagnet ON and OFF.</li> <li>Do not place a transceiver near the Sensor or its wiring. Doing so may cause malfunction.</li> </ul>				
<p>Other considerations</p>	<p>Cost feasibility: Price/delivery time</p>	<p>Life: Power-ON time/frequency of use</p>			

\* mT (millitesla) is a unit for expressing magnetic flux density. One tesla is the equivalent of 10,000 gauss.



## ●Design

### Sensing Object Material

The sensing distance varies greatly depending on the material of the sensing object. Study the engineering data for the influence of sensing object material and size and select a distance with sufficient leeway.

- In general, if the sensing object is a non-magnetic metal (for example, aluminum), the sensing distance decreases.

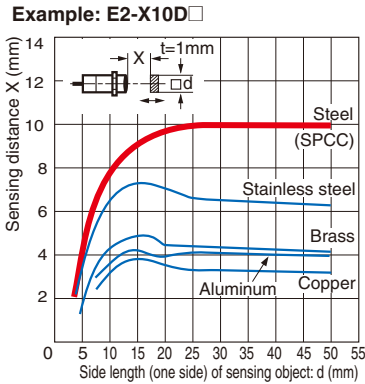

### Size of Sensing Object

In general, if the object is smaller than the standard sensing object, the sensing distance decreases.

- Design the setup for an object size that is the same or greater than the standard sensing object size from the graphs showing the sensing object size and sensing distance.
- When the size of the standard sensing object is the same or less than the size of the standard sensing object, select a sensing distance with sufficient leeway.

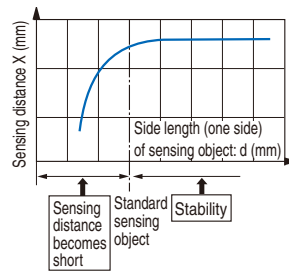

### Thickness of Sensing Object

- The thickness of ferrous metals (iron, nickel, etc.) must be 1 mm or greater.
- When the coating thickness is 0.01 mm or less, a sensing distance equivalent to a magnetic body can be obtained. When the coating is extremely thin and is not conductive, such as a vacuum deposited film, detection is not possible.

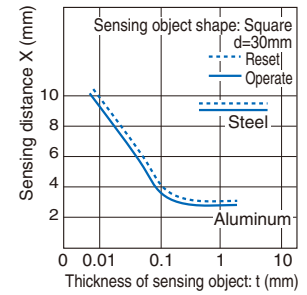

- **Influence of Plating** If the sensing object is plated, the sensing distance will change (see the table below).

Effect of Plating (Typical)

(Reference values: Percent of non-plated sensing distance)

Thickness and base material of plating	Steel	Brass
No plating	100	100
Zn 5 to 15 $\mu\text{m}$	90 to 120	95 to 105
Cd 5 to 15 $\mu\text{m}$	100 to 110	95 to 105
Ag 5 to 15 $\mu\text{m}$	60 to 90	85 to 100
Cu 10 to 20 $\mu\text{m}$	70 to 95	95 to 105
Cu 5 to 15 $\mu\text{m}$	-	95 to 105
Cu (5 to 10 $\mu\text{m}$ ) + Ni (10 to 20 $\mu\text{m}$ )	70 to 95	-
Cu (5 to 10 $\mu\text{m}$ ) + Ni (10 $\mu\text{m}$ ) + Cr (0.3 $\mu\text{m}$ )	75 to 95	-

### Mutual Interference

- Mutual interference refers to a state where a Sensor is affected by magnetism (or static capacitance) from an adjacent Sensor and the output is unstable.
- One means of avoiding interference when mounting Proximity Sensors close together is to alternate Sensors with different frequencies. The model tables indicate whether different frequencies are available. Please refer to the tables.
- When Proximity Sensors with the same frequency are mounted together in a line or face-to-face, they must be separated by a minimum distance. For details, refer to *Mutual Interference* in the *Safety Precautions* for individual Sensors.

### Power Reset Time

A Sensor is ready for detection within 100 ms after turning ON the power. If the load and Sensor are connected to separate power supplies, design the system so that the Sensor power turns ON first.

# Proximity Sensors Technical Guide

## Turning OFF the Power

An output pulse may be generated when the power is turned OFF, so design the system so that the load or load line power turns OFF first.

## Influence of Surrounding Metal

The existence of a metal object other than the sensing object near the sensing surface of the Proximity Sensor will affect detection performance, increase the apparent operating distance, degrade temperature characteristics, and cause reset failures. For details, refer to the influence of surrounding metal table in *Safety Precautions* for individual Sensors.

The values in the table are for the nuts provided with the Sensors. Changing the nut material will change the influence of the surrounding metal.

## Power Transformers

Be sure to use an insulated transformer for a DC power supply. Do not use an auto-transformer (single-coil transformer).

## Precautions for AC 2-Wire/DC 2-Wire Sensors

### Surge Protection

Although the Proximity Sensor has a surge absorption circuit, if there is a device (motor, welder, etc.) that causes large surges near the Proximity Sensor, insert a surge absorber near the source of the surges.

### Influence of Leakage Current

Even when the Proximity Sensor is OFF, a small amount of current runs through the circuit as leakage current.

For this reason, a small current may remain in the load (residual voltage in the load) and cause load reset failures. Verify that this voltage is lower than the load reset voltage (the leakage current is less than the load reset current) before using the Sensor.

### Using an Electronic Device as the Load for an AC 2-Wire Sensor

When using an electronic device, such as a Timer, some types of devices use AC half-wave rectification. When a Proximity Sensor is connected to a device using AC half-wave rectification, only AC half-wave power will be supplied to the Sensor. This will cause the Sensor operation to be unstable. Also, do not use a Proximity Sensor to turn the power supply ON and OFF for electronic devices that use DC half-wave rectification. In such a case, use a relay to turn the power supply ON and OFF, and check the system for operating stability after connecting it.

Examples of Timers that Use AC Half-wave Rectification

Timers: H3Y, H3YN, H3RN, H3CA-8, RD2P, and H3CR (-A, -A8, -AP, -F, -G)

## Countermeasures for Leakage Current (Examples)

### AC 2-Wire Sensors

Connect a bleeder resistor to bypass the leakage current flowing in the load so that the current flowing through the load is less than the load reset current.

When using an AC 2-Wire Sensor, connect a bleeder resistor so that the Proximity Sensor current is at least 10 mA, and the residual load voltage when the Proximity Sensor is OFF is less than the load reset voltage.

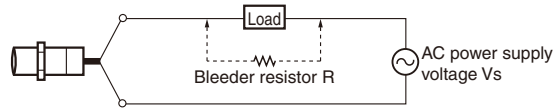

Calculate the bleeder resistance and allowable power using the following equation.

$$R \leq \frac{V_s}{10 - I} \text{ (k}\Omega\text{)} \quad P > \frac{V_s^2}{R} \text{ (mW)}$$

- P : Watts of bleeder resistance (the actual number of watts used should be several times this number)
- I : Load current (mA)

It is recommended that leeway be included in the actual values used. For 100 VAC, use 10 k $\Omega$  or less and 3 W (5 W) or higher, and for 200 VAC, use 20 k $\Omega$  or less and 10 W (20 W) or higher. If the effects of heat generation are a problem, use the number of watts in parentheses ( ) or higher.

### DC 2-Wire Sensors

Connect a bleeder resistor to bypass the leakage current flowing in the load, and design the load current so that (leakage current)  $\times$  (load input impedance) < reset voltage.

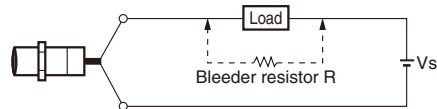

Calculate the bleeder resistance and allowable power using the following equation.

$$R \leq \frac{V_s}{i_R - i_{OFF}} \text{ (k}\Omega\text{)} \quad P > \frac{V_s^2}{R} \text{ (mW)}$$

- P : Watts of bleeder resistance (the actual number of watts used should be several times this number)
- $i_R$  : Leakage current of Proximity Sensor (mA)
- $i_{OFF}$  : Load reset current (mA)

It is recommended that leeway be included in the actual values used. For 12 VDC, use 15 k $\Omega$  or less and 450 mW or higher, and for 24 VDC, use 30 k $\Omega$  or less and 0.1 W or higher.

## Loads with Large Inrush Current

Loads, such as lamps or motors, that cause a large inrush current\*\* will weaken or damage the switching element. In this situation, use a relay.

\* E2K, TL-N□Y: 1 A or higher

## ●Mounting

### Mounting the Sensor

When mounting a Sensor, do not tap it with a hammer or otherwise subject it to excessive shock. This will weaken water resistance and may damage the Sensor. If the Sensor is being secured with bolts, observe the allowable tightening torque. Some models require the use of toothed washers.

For details, refer to the mounting precautions in *Precautions for Correct Use* in individual product information.

### Mounting/Removing Using DIN Track

#### (Example for E2CY)

##### <Mounting>

- (1) Insert the front of the Sensor into the special Mounting Bracket (included) or DIN Track.
- (2) Press the rear of the Sensor into the special Mounting Bracket or DIN Track.

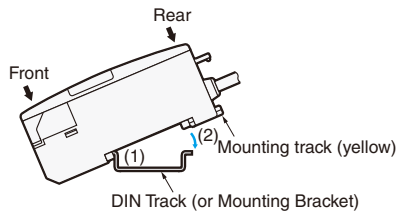

- When mounting the side of the Sensor using the special Mounting Bracket, first secure the Amplifier Unit to the special Mounting Bracket, and then mount the special Mounting Bracket with M3 screws and flat washers with a diameter of 6 mm maximum.

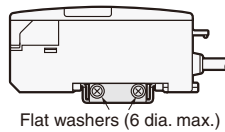

##### <Removing>

- While pressing the Amplifier Unit in the direction of (3), lift the fiber plug in the direction of (4) for easy removal without a screwdriver.

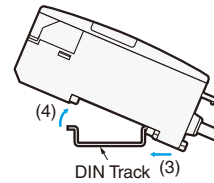

##### Set Distance

The sensing distance may vary due to fluctuations in temperature and voltage. When mounting the Sensor, it is recommended that installation be based on the set distance.

# Proximity Sensors Technical Guide

## ●Wiring Considerations

### AND/OR Connections for Proximity Sensors

Model	Type of connection	Connection	Description
DC 2-Wire	AND (series connection)		<p>Keep the number of connected Sensors (N) within the range of the following equation.</p> $V_s - N \times V_R \geq \text{Operating load voltage}$ <p> <math display="block">\left\{ \begin{array}{l} N : \text{Number of Sensors that can be connected} \\ V_R : \text{Residual output voltage of Proximity Sensor} \\ V_s : \text{Power voltage} \end{array} \right\}</math> </p> <p>It is possible, however, that the indicators may not light correctly and error pulses (of approximately 1 ms) may be generated because the rated power supply voltage and current are not supplied to individual Proximity Sensors. Verify that this is not a problem before operation.</p>
	OR (parallel connection)		<p>Keep the number of connected Sensors (N) within the range of the following equation.</p> $N \times i \leq \text{Load reset current}$ <p> <math display="block">\left\{ \begin{array}{l} N : \text{Number of Sensors that can be connected} \\ i : \text{Leakage current of Proximity Sensor} \end{array} \right\}</math> </p> <p>Example: When an MY (24-VDC) Relay is used as the load, the maximum number of Sensors that can be connected is 4.</p>
AC 2-wire	AND (series connection)		<p>&lt;TL-NY, TL-MY, E2K-□MY□, TL-□□Y&gt; The above Proximity Sensors cannot be used in a series connection. If needed, connect through relays.</p> <p>&lt;E2E-X□Y&gt; For the above Proximity Sensors, the voltage VL that can be applied to the load when ON is <math>V_L = V_s - (\text{Output residual voltage} \times \text{Number of Sensors})</math>, for both 100 VAC and 200 VAC. The load will not operate unless VL is higher than the load operating voltage. This must be verified before use. When using two or more Sensors in series with an AND circuit, the limit is three Sensors. (Be careful of the VS value in the diagram at left.)</p>
	OR (parallel connection)		<p>In general it is not possible to use two or more Proximity Sensors in parallel with an OR circuit.</p> <p>A parallel connection can be used if A and B will not be operated simultaneously and there is no need to hold the load. The leakage current, however, will be n times the value for each Sensor and reset failures will frequently occur. ("n" is the number of Proximity Sensors.)</p> <p>If A and B will be operated simultaneously and the load is held, a parallel connection is not possible. If A and B operate simultaneously and the load is held, the voltages of both A and B will fall to about 10 V when A turns ON, and the load current will flow through A causing random operation. When the sensing object approaches B, the voltage of both terminals of B is too low at 10 V and the switching element of B will not operate. When A turns OFF again, the voltages of both A and B rise to the power supply voltage and B is finally able to turn ON.</p> <p>During this period, there are times when A and B both turn OFF (approximately 10 ms) and the loads are momentarily restored. In cases where the load is to be held in this way, use a relay as shown in the diagram at left.</p>

Note: When AND/OR connections are used with Proximity Sensors, the effects of erroneous pulses or leakage current may prevent use. Verify that there are no problems before use.

# Proximity Sensors Technical Guide

Model	Type of connection	Connection	Description
DC 3-wire	AND (series connection)		<p>Keep the number of connected Sensors (N) within the range of the following equation.</p> $i_L + (N - 1) \times i \leq \text{Upper limit of Proximity Sensor control output}$ $V_s - N \times V_R \geq \text{Operating load voltage}$ <p> <math>N</math>: Number of Sensors that can be connected  <math>V_R</math>: Residual output voltage of Sensor  <math>V_s</math>: Power supply voltage  <math>i</math>: Current consumption of Sensor  <math>i_L</math>: Load current                 </p> <p>Note: When an AND circuit is connected, the operation of Proximity Sensor B causes power to be supplied to Proximity Sensor A, and thus erroneous pulses (approximately 1 ms) may be generated in A when the power is turned ON. For this reason, take care when the load has a high response speed because malfunction may result.</p>
	OR (parallel connection)		<p>For Sensors with a current output, a minimum of three OR connections is possible. Whether or not four or more connections is possible depends on the model.</p>

Note: When AND/OR connections are used with Proximity Sensors, the effects of erroneous pulses or leakage current may prevent use. Verify that there are no problems before use.

## Extending Cable Length

The cable of a Built-in Amplifier Sensor can be extended to a maximum length of 200 m with each of the standard cables (excluding some models).

For Separate Amplifier Sensors (E2C-EDA, E2C, E2J, E2CY), refer to the specific precautions for individual products.

## Bending the Cable

If you need to bend the cable, we recommend a bend radius that is at least 3 times the outer diameter of the cable (with the exception of coaxial and shielded cables).

## Cable Tensile Strength

In general, do not subject the cable to a tension greater than that indicated in the following table.

Cable diameter	Tensile strength
Less than 4 mm	30 N max.
4 mm min.	50 N max.

Note: Do not subject a shielded cable or coaxial cable to tension.

## Separating High-voltage Lines

Using Metal Conduits

If a power line is to be located near the Proximity Sensor cable, use a separate metal conduit to prevent malfunction or damage. (Same for DC models.)

## Example of Connection with S3D2 Sensor Controller

### DC 2-Wire Sensors

#### Using the S3D2 Sensor Controller

Operation can be reversed with the signal input switch on the S3D2.

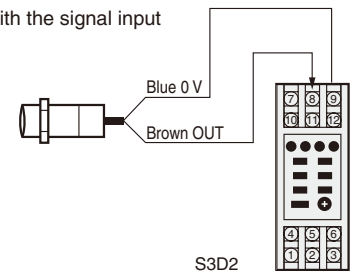

#### Connecting to a Relay Load

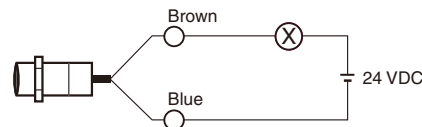

Note: DC 2-Wire Sensors have a residual voltage of 3 V. Check the operating voltage of the relay before use.  
The residual voltage of the E2E-XD-M1J-T is 5 V.

### DC 3-Wire Sensors

Operation can be reversed with the signal input switch on the S3D2.

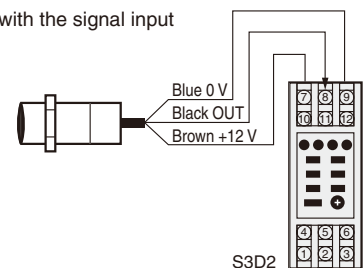

## ●Operating Environment

### Water Resistance

Do not use the Sensor in water, rain, or outdoors.

### Ambient Conditions

Do not use the Sensor in the following environments. Doing so may cause malfunction or failure of the Sensor.

1. To maintain operational reliability and service life, use the Sensor only within the specified temperature range and do not use it outdoors.
2. The Sensor has a water resistant structure, however, attaching a cover to prevent direct contact with water will help improve reliability and prolong product life.
3. Avoid using the Sensor where there are chemical vapors, especially strong alkalis or acids (nitric acid, chromic acid, or hot concentrated sulfuric acid).

## ●Maintenance and inspection

### Periodic Inspection

To ensure long-term stable operation of the Proximity Sensor, inspect for the following on a regular basis. Conduct these inspections also for control devices.

1. Shifting, loosening, or deformation of the sensing object and Proximity Sensor mounting
2. Loosening, bad contact, or wire breakage in the wiring and connections
3. Adherence or accumulation of metal powder
4. Abnormal operating temperature or ambient conditions
5. Abnormal indicator flashing (on setting indicator types)

### Disassembly and Repair

Do not under any circumstances attempt to disassemble or repair the product.

### Quick Failure Check

You can conveniently check for failures by connecting the E39-VA Handy Checker to check the operation of the Sensor.

## Read and Understand This Catalog

Please read and understand this catalog before purchasing the products. Please consult your OMRON representative if you have any questions or comments.

## Warranty and Limitations of Liability

### WARRANTY

OMRON's exclusive warranty is that the products are free from defects in materials and workmanship for a period of one year (or other period if specified) from date of sale by OMRON.

OMRON MAKES NO WARRANTY OR REPRESENTATION, EXPRESS OR IMPLIED, REGARDING NON-INFRINGEMENT, MERCHANTABILITY, OR FITNESS FOR PARTICULAR PURPOSE OF THE PRODUCTS. ANY BUYER OR USER ACKNOWLEDGES THAT THE BUYER OR USER ALONE HAS DETERMINED THAT THE PRODUCTS WILL SUITABLY MEET THE REQUIREMENTS OF THEIR INTENDED USE. OMRON DISCLAIMS ALL OTHER WARRANTIES, EXPRESS OR IMPLIED.

### LIMITATIONS OF LIABILITY

OMRON SHALL NOT BE RESPONSIBLE FOR SPECIAL, INDIRECT, OR CONSEQUENTIAL DAMAGES, LOSS OF PROFITS, OR COMMERCIAL LOSS IN ANY WAY CONNECTED WITH THE PRODUCTS, WHETHER SUCH CLAIM IS BASED ON CONTRACT, WARRANTY, NEGLIGENCE, OR STRICT LIABILITY.

In no event shall responsibility of OMRON for any act exceed the individual price of the product on which liability is asserted.

IN NO EVENT SHALL OMRON BE RESPONSIBLE FOR WARRANTY, REPAIR, OR OTHER CLAIMS REGARDING THE PRODUCTS UNLESS OMRON'S ANALYSIS CONFIRMS THAT THE PRODUCTS WERE PROPERLY HANDLED, STORED, INSTALLED, AND MAINTAINED AND NOT SUBJECT TO CONTAMINATION, ABUSE, MISUSE, OR INAPPROPRIATE MODIFICATION OR REPAIR.

## Application Considerations

### SUITABILITY FOR USE

OMRON shall not be responsible for conformity with any standards, codes, or regulations that apply to the combination of products in the customer's application or use of the product.

At the customer's request, OMRON will provide applicable third party certification documents identifying ratings and limitations of use that apply to the products. This information by itself is not sufficient for a complete determination of the suitability of the products in combination with the end product, machine, system, or other application or use.

The following are some examples of applications for which particular attention must be given. This is not intended to be an exhaustive list of all possible uses of the products, nor is it intended to imply that the uses listed may be suitable for the products:

- Outdoor use, uses involving potential chemical contamination or electrical interference, or conditions or uses not described in this catalog.
- Nuclear energy control systems, combustion systems, railroad systems, aviation systems, medical equipment, amusement machines, vehicles, safety equipment, and installations subject to separate industry or government regulations.
- Systems, machines, and equipment that could present a risk to life or property.

Please know and observe all prohibitions of use applicable to the products.

NEVER USE THE PRODUCTS FOR AN APPLICATION INVOLVING SERIOUS RISK TO LIFE OR PROPERTY WITHOUT ENSURING THAT THE SYSTEM AS A WHOLE HAS BEEN DESIGNED TO ADDRESS THE RISKS, AND THAT THE OMRON PRODUCT IS PROPERLY RATED AND INSTALLED FOR THE INTENDED USE WITHIN THE OVERALL EQUIPMENT OR SYSTEM.

## Disclaimers

### CHANGE IN SPECIFICATIONS

Product specifications and accessories may be changed at any time based on improvements and other reasons.

It is our practice to change model numbers when published ratings or features are changed, or when significant construction changes are made. However, some specifications of the product may be changed without any notice. When in doubt, special model numbers may be assigned to fix or establish key specifications for your application on your request. Please consult with your OMRON representative at any time to confirm actual specifications of purchased product.

### DIMENSIONS AND WEIGHTS

Dimensions and weights are nominal and are not to be used for manufacturing purposes, even when tolerances are shown.

### ERRORS AND OMISSIONS

The information in this catalog has been carefully checked and is believed to be accurate; however, no responsibility is assumed for clerical, typographical, or proofreading errors, or omissions.

### PERFORMANCE DATA

Performance data given in this catalog is provided as a guide for the user in determining suitability and does not constitute a warranty. It may represent the result of OMRON's test conditions, and the users must correlate it to actual application requirements. Actual performance is subject to the OMRON Warranty and Limitations of Liability.

### PROGRAMMABLE PRODUCTS

OMRON shall not be responsible for the user's programming of a programmable product, or any consequence thereof.

### COPYRIGHT AND COPY PERMISSION

This catalog shall not be copied for sales or promotions without permission.

This catalog is protected by copyright and is intended solely for use in conjunction with the product. Please notify us before copying or reproducing this catalog in any manner, for any other purpose. If copying or transmitting this catalog to another, please copy or transmit it in its entirety.