

**Description**

AH180 is a micro-power Omnipolar Hall-Effect switch designed for portable and battery powered equipment such as cellular phones, PDAs and portable PCs. Based on two Hall-Effect plates and a chopper stabilized architecture the AH180 provides a reliable solution over the whole operating range. To support portable and battery powered equipment the design has been optimized to operate over the supply range of 2.5V to 5.5V and consumes only 24uW with a supply of 3V.

The single open-drain output switches on with either a north or south pole of sufficient strength. When the magnetic flux density (**B**) is larger than operate point (**Bop**), output is switched on (Output pin is pulled low). The output is turned off when **B** becomes lower than the release point (**Brp**). The output will remain off when there is no magnetic field.

The AH180 is available in SIP-3L, SC59, DFN2020-3, and DFN2020-6 packages.

**Features**

- Omnipolar (north or south pole) operation
- Micropower operation
- Single open drain output
- 2.5V to 5.5V operating voltage
- Chopper stabilized design provides
  - Superior temperature stability
  - Minimal switch-point drift
  - Enhanced immunity to stress
- Good RF noise immunity
- -40°C to 85°C operating temperature
- ESD (HBM) > 5KV for DFN2020-6, DFN2020-3  
> 6KV for SIP-3L and SC59
- SIP-3L, SC59 (commonly known as SOT23 in Asia)  
DFN2020-6, DFN2020-3 packages
- Green Molding Compound (No Br, Sb) (Note 1)

Notes: 1. EU Directive 2002/95/EC (RoHS). All applicable RoHS exemptions applied. Please visit our website at [http://www.diodes.com/products/lead\\_free.html](http://www.diodes.com/products/lead_free.html).

**Pin Assignments**

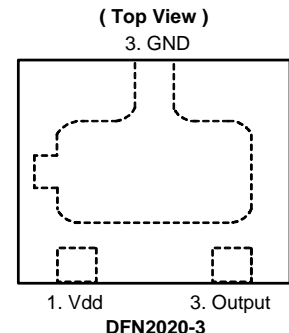
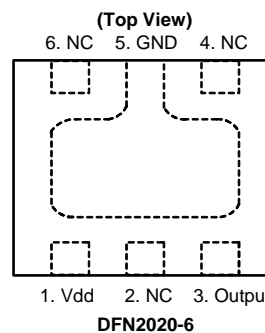
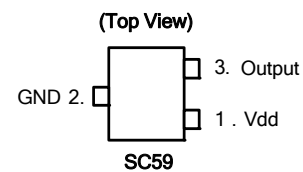
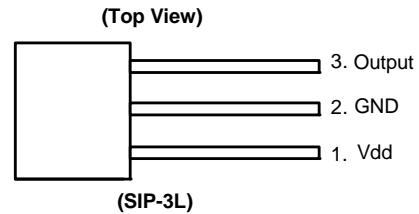

**Applications**

- Cover switch in clam-shell cellular phones
- Cover switch in Notebook PC/PDA
- Contact-less switch in consumer products

**Typical Application Circuit**

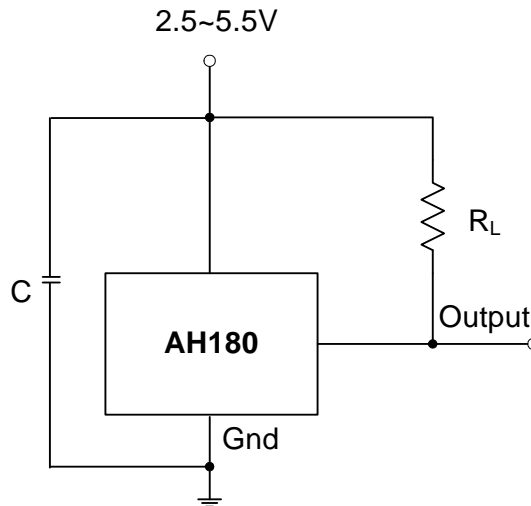

Note: C is for power stabilization and to strengthen the noise immunity, the recommended capacitance is 10nF~100nF.  
RL is the pull-up resistor, the recommended resistance is 10Kohm~100Kohm.

**Pin Descriptions**

Pin Name	P/I/O	Description
Vdd	P/I	Power Supply Input
GND	P/I	Ground
Output	O	Output Pin
NC	NC	No Connected

**Functional Block Diagram**

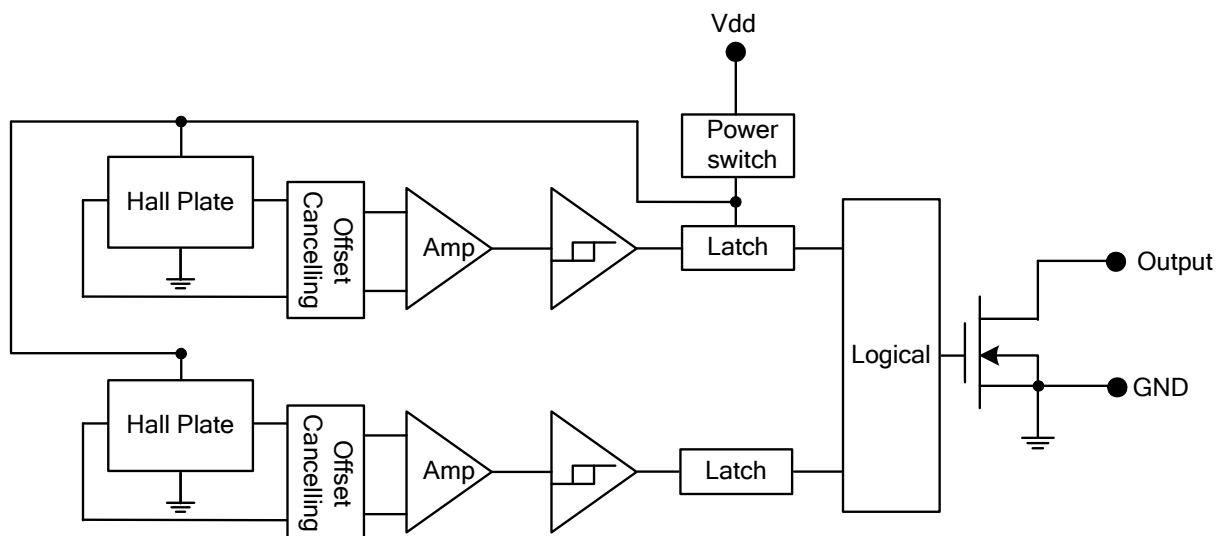

### Absolute Maximum Ratings ( $T_A = 25^\circ\text{C}$ )

Symbol	Characteristics	Values	Unit	
Vdd	Supply voltage	7	V	
B	Magnetic flux density	Unlimited		
Ts	Storage Temperature Range	-65 to +150	$^\circ\text{C}$	
P <sub>D</sub>	Package Power Dissipation	SIP-3L	550	mW
		SC59-3L/ DFN2020-6/ DFN2020-3	230	mW
T <sub>J</sub>	Maximum Junction Temperature	150	$^\circ\text{C}$	

### Recommended Operating Conditions

Symbol	Parameter	Conditions	Min	Max	Unit
Vdd	Supply Voltage	Operating	2.5	5.5	V
T <sub>A</sub>	Operating Ambient Temperature	Operating	-40	85	$^\circ\text{C}$

### Electrical Characteristics ( $T_A = 25^\circ\text{C}$ , Vdd = 3V; unless otherwise specified)

Symbol	Characteristic	Conditions	Min	Typ.	Max	Unit
Vout	Output On Voltage	I <sub>out</sub> = 1mA	—	0.1	0.3	V
I <sub>off</sub>	Output Leakage Current	Vout = 5.5V, Output off	—	<0.1	1	$\mu\text{A}$
I <sub>dd(en)</sub>	Supply Current	Chip enable, $T_A = 25^\circ\text{C}$ , Vdd = 3V	—	3	6	mA
I <sub>dd(en)</sub>		Chip enable, $T_A = -40\sim 85^\circ\text{C}$ , Vdd = 2.5~5.5V	—	3	9	mA
I <sub>dd(dis)</sub>		Chip disable, $T_A = 25^\circ\text{C}$ , Vdd = 3V	—	5	10	$\mu\text{A}$
I <sub>dd(dis)</sub>		Chip disable, $T_A = -40\sim 85^\circ\text{C}$ , Vdd = 2.5~5.5V	—	5	15	$\mu\text{A}$
I <sub>dd(avg)</sub>		Average supply current, $T_A = 25^\circ\text{C}$ , Vdd = 3V	—	8	16	$\mu\text{A}$
I <sub>dd(avg)</sub>		Average supply current, $T_A = -40\sim 85^\circ\text{C}$ , Vdd = 2.5~5.5V	—	8	24	$\mu\text{A}$
T <sub>awake</sub>	Awake Time	(Note 2)	—	75	125	$\mu\text{s}$
T <sub>period</sub>	Period	(Note 2)	—	75	125	ms
D.C.	Duty Cycle		—	0.1	—	%

Notes: 2. When power is initially turned on, Vdd must be within its correct operating range (2.5V to 5.5V) to guarantee the output sampling. The output state is valid after the second operating phase (typical 150ms).

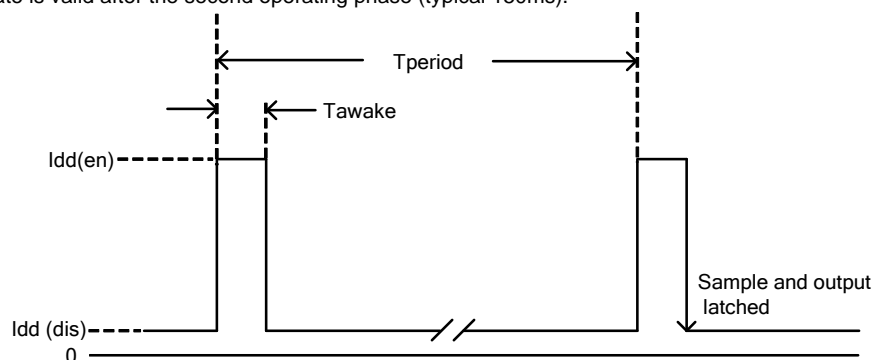

**Magnetic Characteristics** ( $T_A = 25\text{ }^\circ\text{C}$ ,  $V_{dd} = 3\text{V}$ , Note 3, 4)

Option 1:

(1mT=10 Gauss)

Symbol	Parameter	Min	Typ.	Max	Unit
Bops(south pole to brand side)	Operation Point	-	40	60	Gauss
Bopn(north pole to brand side)		-60	-40	-	
Brps(south pole to brand side)	Release Point	10	30	-	
Brpn(north pole to brand side)		-	-30	-10	
Bhy( Bopx - Brpx )	Hysteresis	-	15	-	

Option 2:

(1mT=10 Gauss)

Symbol	Parameter	Min	Typ.	Max	Unit
Bops(south pole to brand side)	Operation Point	-	40	60	Gauss
Bopn(north pole to brand side)		-60	-40	-	
Brps(south pole to brand side)	Release Point	20	30	-	
Brpn(north pole to brand side)		-	-30	-20	
Bhy( Bopx - Brpx )	Hysteresis	-	15	-	

Notes: 3. Typical data is at  $T_A = 25\text{ }^\circ\text{C}$ ,  $V_{dd} = 3\text{V}$ , and for design information only.

4. Magnetic characteristics may vary with supply voltage, operating temperature and after soldering.

**Operating Characteristics**

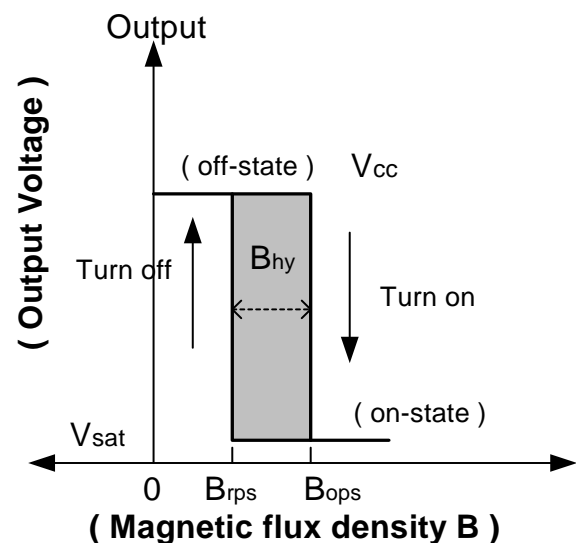
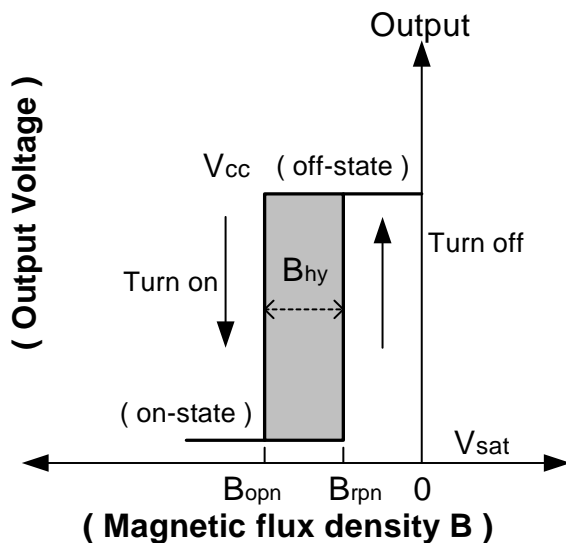

**Performance Characteristics**

**(1) SIP-3L**

$T_A$ (°C)	25	50	60	70	80	85	90	95	100
$P_D$ (mW)	550	440	396	352	308	286	264	242	220
$T_A$ (°C)	105	110	115	120	125	130	135	140	150
$P_D$ (mW)	198	176	154	132	110	88	66	44	0

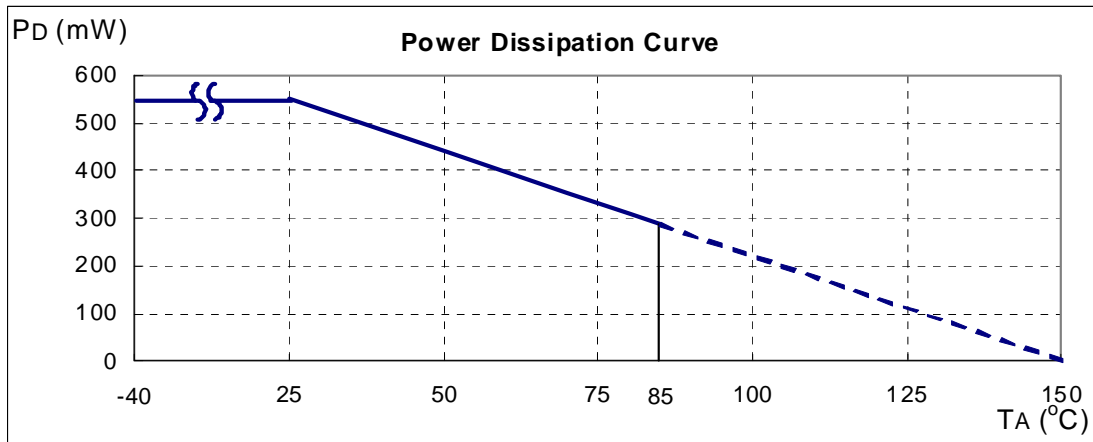

**(2) SC59 (commonly known as SOT23 in Asia), DFN2020-6 and DFN2020-3**

$T_A$ (°C)	25	50	60	70	80	85	90	100	110	120	130	140	150
$P_D$ (mW)	230	184	166	147	129	120	110	92	74	55	37	18	0

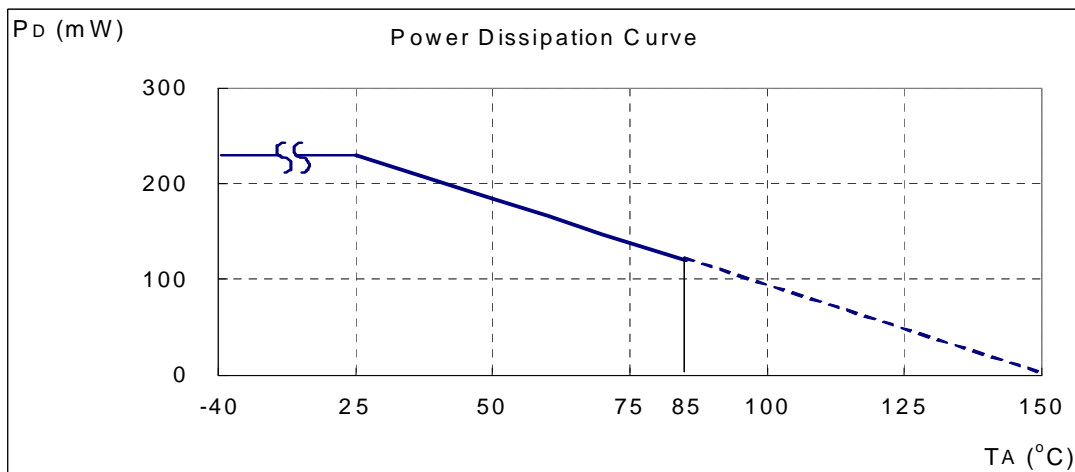

### Ordering Information

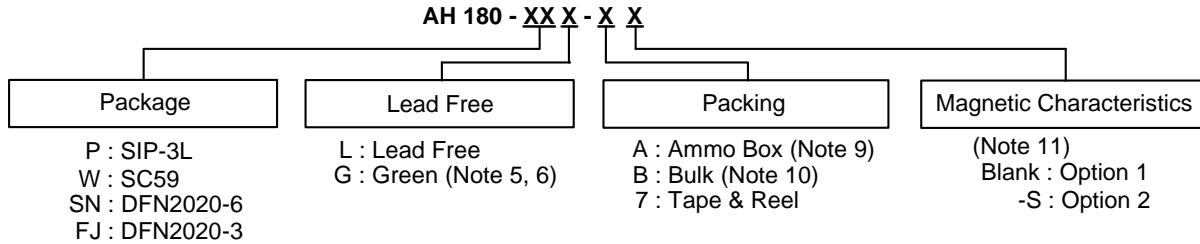

Device	Package Code	Packaging (Note 7, 8)	Bulk		7" Tape and Reel		Ammo Box		Magnetic Characteristics (Note 11)
			Quantity	Part Number Suffix	Quantity	Part Number Suffix	Quantity	Part Number Suffix	
AH180-PL-B	P	SIP-3L	1000	-B	NA	NA	NA	NA	Blank
AH180-PL-A	P	SIP-3L	NA	NA	NA	NA	-A	4000/Box	Blank
AH180-PG-B	P	SIP-3L	1000	-B	NA	NA	NA	NA	Blank
AH180-PG-A	P	SIP-3L	NA	NA	NA	NA	-A	4000/Box	Blank
AH180-PL-B-S	P	SIP-3L	1000	-B	NA	NA	NA	NA	S
AH180-PL-A-S	P	SIP-3L	NA	NA	NA	NA	-A	4000/Box	S
AH180-PG-B-S	P	SIP-3L	1000	-B	NA	NA	NA	NA	S
AH180-PG-A-S	P	SIP-3L	NA	NA	NA	NA	-A	4000/Box	S
AH180-WG-7	W	SC59	NA	NA	3000/Tape & Reel	-7	NA	NA	Blank
AH180-SNG-7	SN	DFN2020-6	NA	NA	3000/Tape & Reel	-7	NA	NA	Blank
AH180-FJG-7	FJ	DFN2020-3	NA	NA	3000/Tape & Reel	-7	NA	NA	Blank

- Notes:
5. SC59, DFN2020-6 and DFN2020-3 are available in "Green" product only.
  6. EU Directive 2002/95/EC (RoHS). All applicable RoHS exemptions applied. Please visit our website at [http://www.diodes.com/products/lead\\_free.html](http://www.diodes.com/products/lead_free.html).
  7. Pad layout as shown on Diodes Inc. suggested pad layout document AP02001, which can be found on our website at <http://www.diodes.com/datasheets/ap02001.pdf>.
  8. Reverse taping as shown on Diodes Inc. Surface Mount (SMD) Packaging document AP02007, which can be found on our website <http://www.diodes.com/datasheets/ap02007.pdf>.
  9. Ammo Box is for SIP-3L Spread Lead.
  10. Bulk is for SIP-3L Straight Lead.
  11. Please refer the Magnetic Characteristics table, option 2 is available in SIP-3L package only.

**Marking Information**

(1) SIP-3L

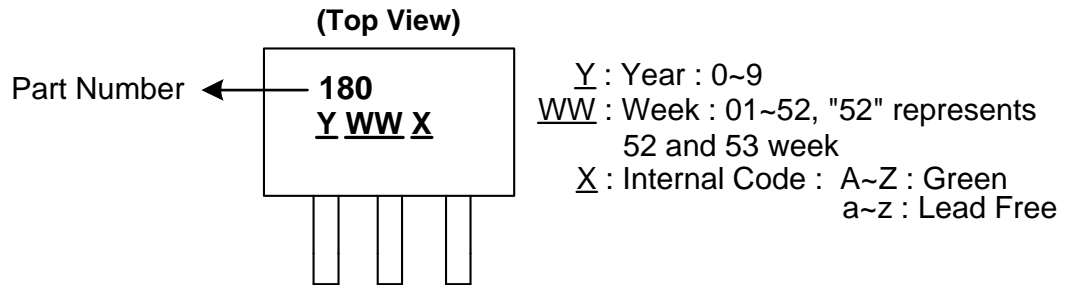

(2) SC59 (commonly known as SOT23 in Asia)

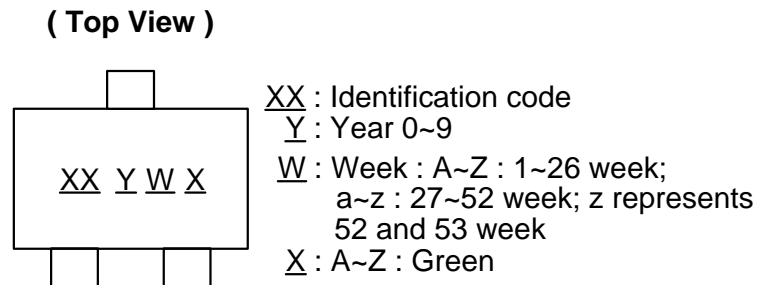

Part Number	Package	Identification Code
AH180	SC59	K0

(3) DFN2020-6

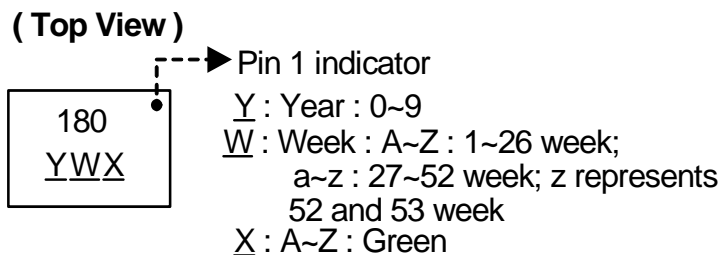

**Marking Information (Continued)**

(4) DFN2020-3

**( Top View )**

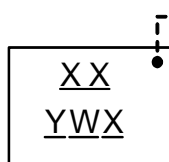

Pin 1 indicator

XX : Identification Code

Y : Year : 0~9

W : Week : A~Z : 1~26 week;  
a~z : 27~52 week; z represents  
52 and 53 week

X : A~Z : Green

Part Number	Package	Identification Code
AH180	DFN2020-3	K0



**Package Outline Dimensions (All Dimensions in mm)**

**(1) Package Type: SIP-3L for Bulk pack**

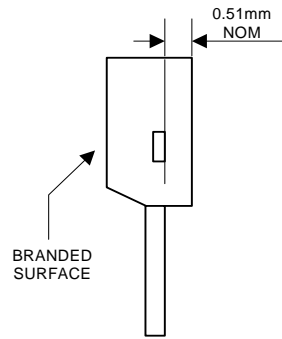

Active Area Depth

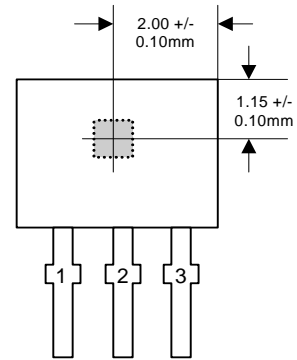

Sensor Location

**Package Dimension**

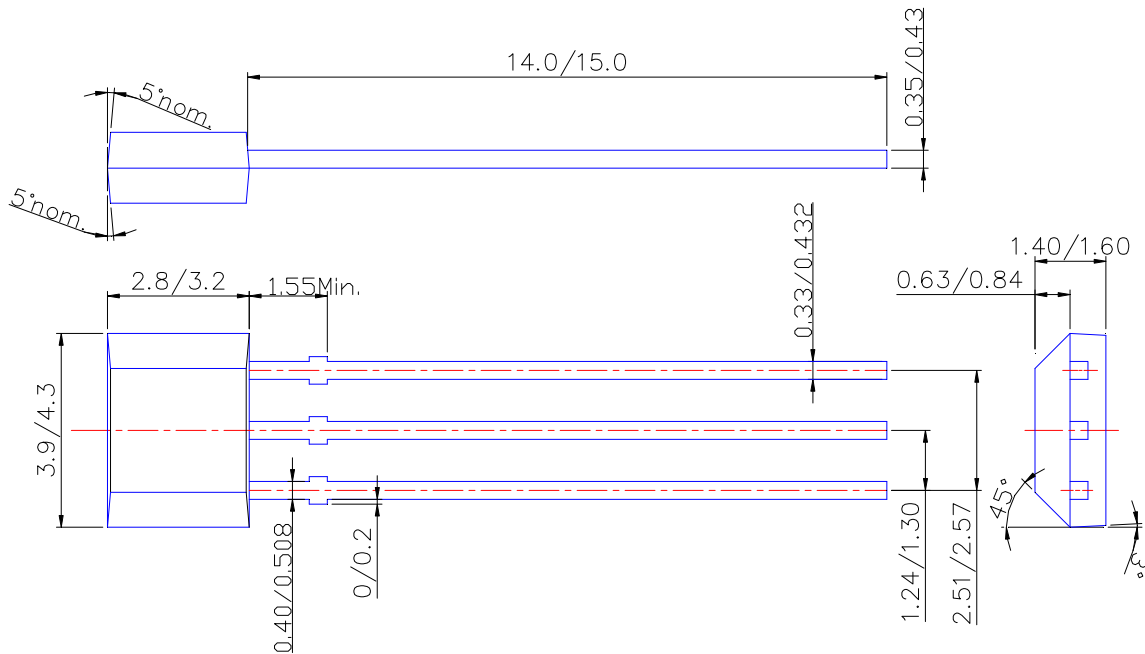



**Package Outline Dimensions (Continued)**

**(4) Package Type: DFN2020-6**

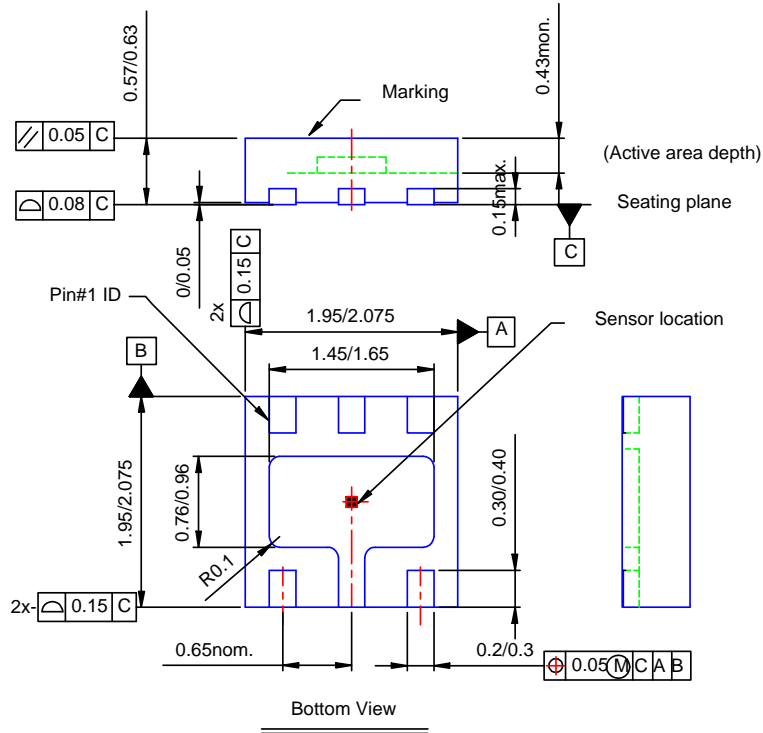

**(5) Package Type: DFN2020-3**

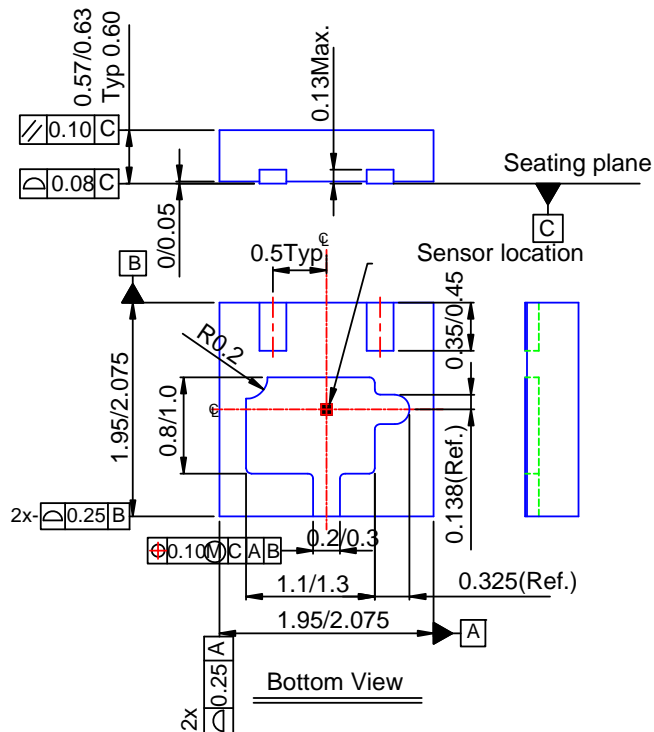

**Taping Orientation (Note 12)**

(1) DFN2020-6

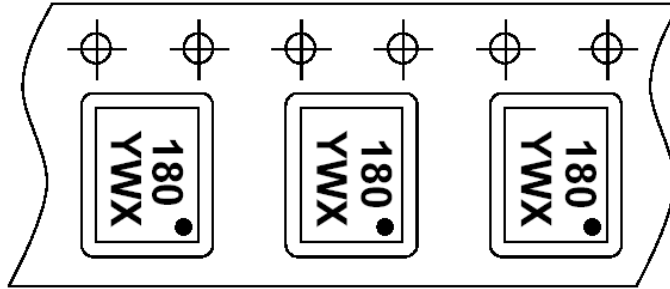

(2) DFN2020-3

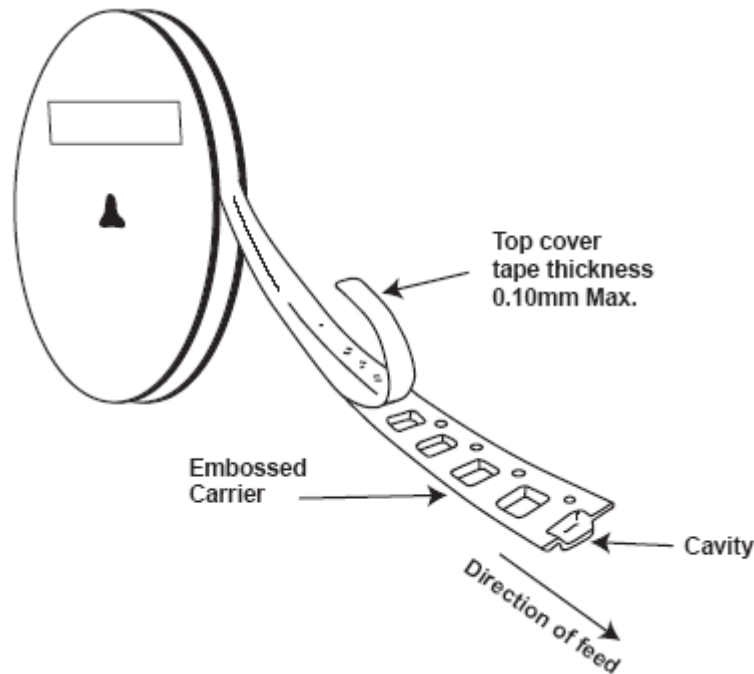
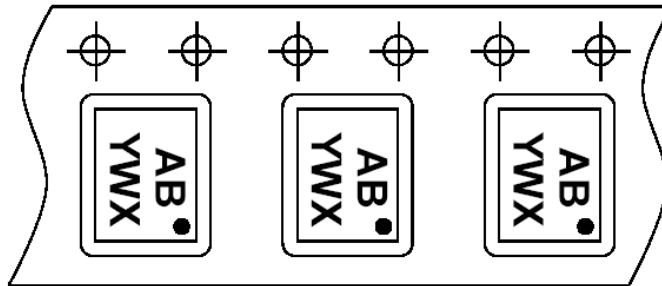

Notes: 12. The taping orientation of the other package type can be found on our website at <http://www.diodes.com/datasheets/ap02007.pdf>.

**IMPORTANT NOTICE**

DIODES INCORPORATED MAKES NO WARRANTY OF ANY KIND, EXPRESS OR IMPLIED, WITH REGARDS TO THIS DOCUMENT, INCLUDING, BUT NOT LIMITED TO, THE IMPLIED WARRANTIES OF MERCHANTABILITY AND FITNESS FOR A PARTICULAR PURPOSE (AND THEIR EQUIVALENTS UNDER THE LAWS OF ANY JURISDICTION).

Diodes Incorporated and its subsidiaries reserve the right to make modifications, enhancements, improvements, corrections or other changes without further notice to this document and any product described herein. Diodes Incorporated does not assume any liability arising out of the application or use of this document or any product described herein; neither does Diodes Incorporated convey any license under its patent or trademark rights, nor the rights of others. Any Customer or user of this document or products described herein in such applications shall assume all risks of such use and will agree to hold Diodes Incorporated and all the companies whose products are represented on Diodes Incorporated website, harmless against all damages.

Diodes Incorporated does not warrant or accept any liability whatsoever in respect of any products purchased through unauthorized sales channel.

Should Customers purchase or use Diodes Incorporated products for any unintended or unauthorized application, Customers shall indemnify and hold Diodes Incorporated and its representatives harmless against all claims, damages, expenses, and attorney fees arising out of, directly or indirectly, any claim of personal injury or death associated with such unintended or unauthorized application.

Products described herein may be covered by one or more United States, international or foreign patents pending. Product names and markings noted herein may also be covered by one or more United States, international or foreign trademarks.

**LIFE SUPPORT**

Diodes Incorporated products are specifically not authorized for use as critical components in life support devices or systems without the express written approval of the Chief Executive Officer of Diodes Incorporated. As used herein:

A. Life support devices or systems are devices or systems which:

1. are intended to implant into the body, or
2. support or sustain life and whose failure to perform when properly used in accordance with instructions for use provided in the labeling can be reasonably expected to result in significant injury to the user.

B. A critical component is any component in a life support device or system whose failure to perform can be reasonably expected to cause the failure of the life support device or to affect its safety or effectiveness.

Customers represent that they have all necessary expertise in the safety and regulatory ramifications of their life support devices or systems, and acknowledge and agree that they are solely responsible for all legal, regulatory and safety-related requirements concerning their products and any use of Diodes Incorporated products in such safety-critical, life support devices or systems, notwithstanding any devices- or systems-related information or support that may be provided by Diodes Incorporated. Further, Customers must fully indemnify Diodes Incorporated and its representatives against any damages arising out of the use of Diodes Incorporated products in such safety-critical, life support devices or systems.

Copyright © 2010, Diodes Incorporated

[www.diodes.com](http://www.diodes.com)