



THIS SPEC IS OBSOLETE

Spec No: 38-03027

Spec Title: PALCE22V10 FLASH-ERASABLE
REPROGRAMMABLE CMOS PAL(R)
DEVICE

Sunset Owner: Adrian Mendes (AMV)

Replaced by: None

Selection Guide

Generic Part Number	t _{PD} ns		t _S ns		t _{CO} ns		I _{CC} mA	
	Com'l	Mil/Ind	Com'l	Mil/Ind	Com'l	Mil/Ind	Com'l	Mil/Ind
PALCE22V10-5	5		3		4		130	
PALCE22V10-7	7.5		5		5		130	
PALCE22V10-10	10	10	6	6	7	7	90	150
PALCE22V10-15	15	15	10	10	8	8	90	120
PALCE22V10-25	25	25	15	15	15	15	90	120

Functional Description

The Cypress PALCE22V10 is a CMOS Flash-erasable second-generation programmable array logic device. It is implemented with the familiar sum-of-products (AND-OR) logic structure and the programmable macrocell.

The PALCE22V10 is executed in a 24-pin 300-mil molded DIP, a 300-mil cerDIP, a 28-lead square ceramic leadless chip carrier, a 28-lead square plastic leaded chip carrier, and provides up to 22 inputs and 10 outputs. The PALCE22V10 can be electrically erased and reprogrammed. The programmable macrocell provides the capability of defining the architecture of each output individually. Each of the ten potential outputs may be specified as "registered" or "combinatorial." Polarity of each output may also be individually selected, allowing complete flexibility of output configuration. Further configurability is provided through "array" configurable "output enable" for each potential output. This feature allows the 10 outputs to be reconfigured as inputs on an individual basis, or alternately used as a combination I/O controlled by the programmable array.

PALCE22V10 features a variable product term architecture. There are 5 pairs of product term sums beginning at 8 product terms per output and incrementing by 2 to 16 product terms per output. By providing this variable structure, the PALCE22V10 is optimized to the configurations found in a majority of applications without creating devices that burden the product term structures with unusable product terms and lower performance.

Additional features of the Cypress PALCE22V10 include a synchronous preset and an asynchronous reset product term. These product terms are common to all macrocells, eliminating the need to dedicate standard product terms for initialization functions. The device automatically resets upon power-up.

The PALCE22V10, featuring programmable macrocells and variable product terms, provides a device with the flexibility to

implement logic functions in the 500- to 800-gate-array complexity. Since each of the ten output pins may be individually configured as inputs on a temporary or permanent basis, functions requiring up to 21 inputs and only a single output and down to twelve inputs and ten outputs are possible. The ten potential outputs are enabled using product terms. Any output pin may be permanently selected as an output or arbitrarily enabled as an output and an input through the selective use of individual product terms associated with each output. Each of these outputs is achieved through an individual programmable macrocell. These macrocells are programmable to provide a combinatorial or registered inverting or non-inverting output. In a registered mode of operation, the output of the register is fed back into the array, providing current status information to the array. This information is available for establishing the next result in applications such as control state machines. In a combinatorial configuration, the combinatorial output or, if the output is disabled, the signal present on the I/O pin is made available to the array. The flexibility provided by both programmable product term control of the outputs and variable product terms allows a significant gain in functional density through the use of programmable logic.

Along with this increase in functional density, the Cypress PALCE22V10 provides lower-power operation through the use of CMOS technology, and increased testability with Flash reprogrammability.

Configuration Table

Registered/Combinatorial		
C ₁	C ₀	Configuration
0	0	Registered/Active LOW
0	1	Registered/Active HIGH
1	0	Combinatorial/Active LOW
1	1	Combinatorial/Active HIGH

Macrocell

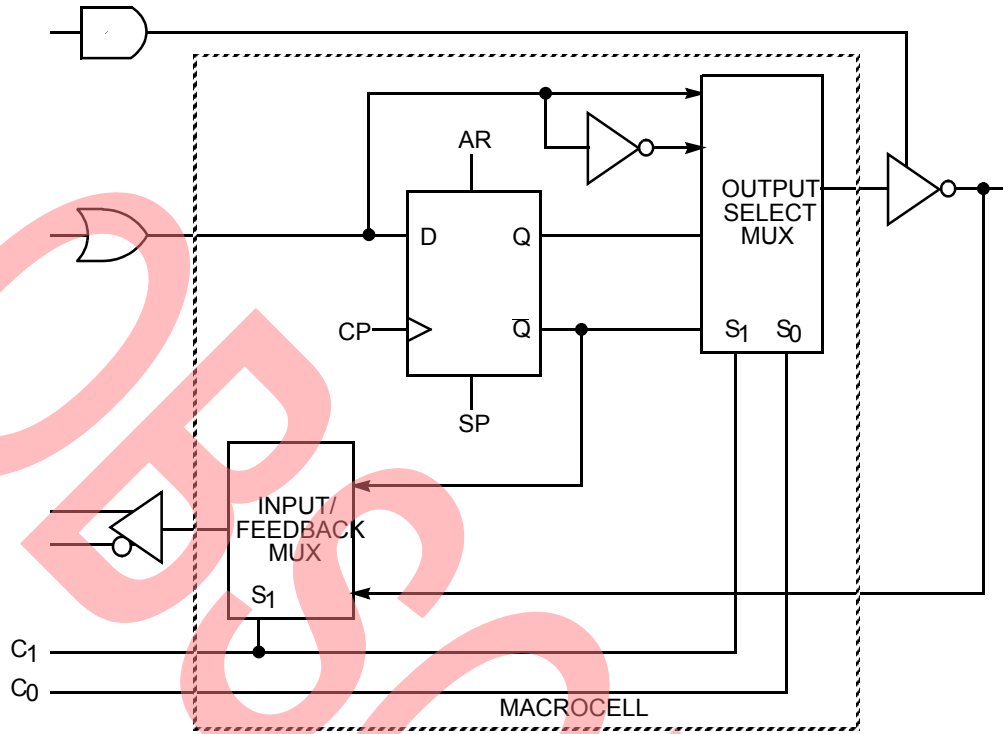



Maximum Ratings

(Above which the useful life may be impaired. For user guidelines, not tested.)

Storage Temperature-65°C to +150°C

Ambient Temperature with Power Applied.....-55°C to +125°C

Supply Voltage to Ground Potential (Pin 24 to Pin 12) -0.5V to +7.0V

DC Voltage Applied to Outputs in High-Z State -0.5V to +7.0V

DC Input Voltage..... -0.5V to +7.0V

Output Current into Outputs (LOW)..... 16 mA

DC Programming Voltage..... 12.5V

Latch-up Current..... > 200 mA

Static Discharge Voltage (per MIL-STD-883, Method 3015) >2001V

Operating Range

Range	Ambient Temperature	V _{CC}
Commercial	0°C to +75°C	5V ±5%
Industrial	-40°C to +85°C	5V ±10%
Military ^[1]	-55°C to +125°C	5V ±10%

Electrical Characteristics Over the Operating Range^[2]

Parameter	Description	Test Conditions	Min.	Max.	Unit		
V _{OH}	Output HIGH Voltage	V _{CC} = Min., V _{IN} = V _{IH} or V _{IL}	I _{OH} = -3.2 mA I _{OH} = -2 mA	Com'l Mil/Ind	2.4	V	
V _{OL}	Output LOW Voltage	V _{CC} = Min., V _{IN} = V _{IH} or V _{IL}	I _{OL} = 16 mA I _{OL} = 12 mA	Com'l Mil/Ind	0.5	V	
V _{IH}	Input HIGH Level	Guaranteed Input Logical HIGH Voltage for All Inputs ^[3]			2.0	V	
V _{IL} ^[4]	Input LOW Level	Guaranteed Input Logical LOW Voltage for All Inputs ^[3]			-0.5	0.8	V
I _{IX}	Input Leakage Current	V _{SS} ≤ V _{IN} ≤ V _{CC} , V _{CC} = Max.			-10	10	μA
I _{OZ}	Output Leakage Current	V _{CC} = Max., V _{SS} ≤ V _{OUT} ≤ V _{CC}			-40	40	μA
I _{SC}	Output Short Circuit Current	V _{CC} = Max., V _{OUT} = 0.5V ^[5,6]			-30	-130	mA
I _{CC1}	Standby Power Supply Current	V _{CC} = Max., V _{IN} = GND, Outputs Open in Unprogrammed Device	10, 15, 25 ns	Com'l	90	mA	
			5, 7.5 ns		130	mA	
			15, 25 ns	Mil/Ind	120	mA	
			10 ns		120	mA	
I _{CC2} ^[6]	Operating Power Supply Current	V _{CC} = Max., V _{IL} = 0V, V _{IH} = 3V, Output Open, Device Programmed as a 10-bit Counter, f = 25 MHz	10, 15, 25 ns	Com'l	110	mA	
			5, 7.5 ns	Com'l	140	mA	
			15, 25 ns	Mil/Ind	130	mA	
			10 ns	Mil/Ind	130	mA	

Capacitance^[6]

Parameter	Description	Test Conditions	Min.	Max.	Unit
C _{IN}	Input Capacitance	V _{IN} = 2.0V @ f = 1 MHz		10	pF
C _{OUT}	Output Capacitance	V _{OUT} = 2.0V @ f = 1 MHz		10	pF

Endurance Characteristics^[6]

Parameter	Description	Test Conditions	Min.	Max.	Unit
N	Minimum Reprogramming Cycles	Normal Programming Conditions	100		Cycles

Notes:

1. T_A is the "instant on" case temperature.
2. See the last page of this specification for Group A subgroup testing information.
3. These are absolute values with respect to device ground. All overshoots due to system or tester noise are included.
4. V_{IL} (Min.) is equal to -3.0V for pulse durations less than 20 ns.
5. Not more than one output should be tested at a time. Duration of the short circuit should not be more than one second. V_{OUT} = 0.5V has been chosen to avoid test problems caused by tester ground degradation.
6. Tested initially and after any design or process changes that may affect these parameters.

AC Test Loads and Waveforms

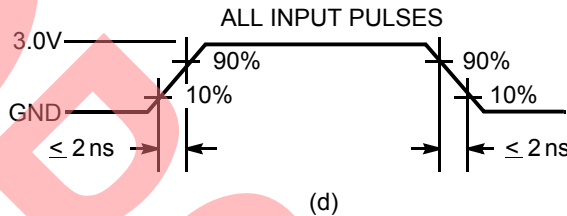
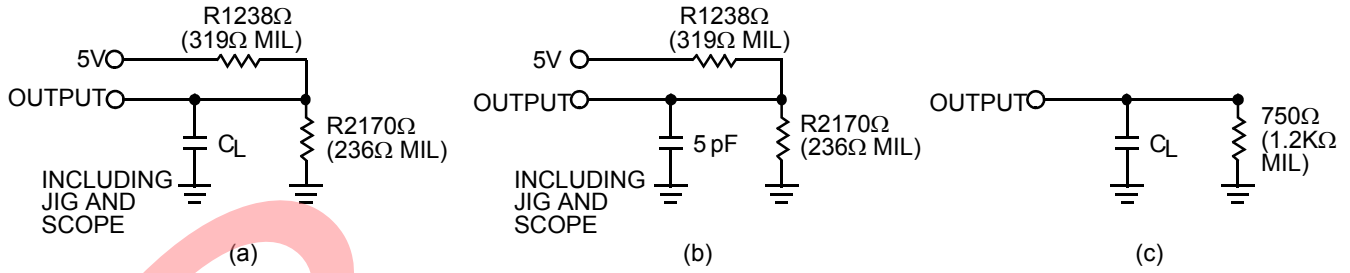

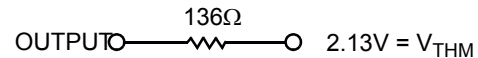

Equivalent to: THÉVENIN Equivalent (Commercial)

Equivalent to: THÉVENIN Equivalent (Military)

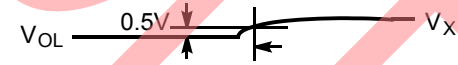
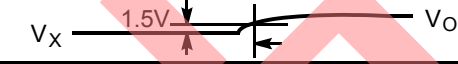

Load Speed	CL	Package
5, 7.5, 10, 15, 25 ns	50 pF	PDIP, CDIP, PLCC, LCC

Parameter	V _X	Output Waveform Measurement Level
t _{ER} (-)	1.5V	
t _{ER} (+)	2.6V	
t _{EA} (+)	0V	
t _{EA} (-)	V _{thc}	

(e) Test Waveforms

Commercial Switching Characteristics PALCE22V10 [2, 7]

Parameter	Description	22V10-5		22V10-7		22V10-10		22V10-15		22V10-25		Unit
		Min.	Max.	Min.	Max.	Min.	Max.	Min.	Max.	Min.	Max.	
t _{PD}	Input to Output Propagation Delay ^[8]	3	5	3	7.5	3	10	3	15	3	25	ns
t _{EA}	Input to Output Enable Delay ^[9]		6		8		10		15		25	ns
t _{ER}	Input to Output Disable Delay ^[10]		6		8		10		15		25	ns
t _{CO}	Clock to Output Delay ^[8]	2	4	2	5	2	7	2	8	2	15	ns

Notes:

- Part (a) of AC Test Loads and Waveforms is used for all parameters except t_{ER} and t_{EA(+)}. Part (b) of AC Test Loads and Waveforms is used for t_{ER}. Part (c) of AC Test Loads and Waveforms is used for t_{EA(+)}.
- Min. times are tested initially and after any design or process changes that may affect these parameters.
- The test load of (a) of AC Test Loads and Waveforms is used for measuring t_{EA(-)}. The test load of (c) of AC Test Loads and Waveforms is used for measuring t_{EA(+)} only. Please see (e) of AC Test Loads and Waveforms for enable and disable test waveforms and measurement reference levels.
- This parameter is measured as the time after output disable input that the previous output data state remains stable on the output. This delay is measured to the point at which a previous HIGH level has fallen to 0.5V below V_{OH} min. or a previous LOW level has risen to 0.5V above V_{OL} max. Please see (e) of AC Test Loads and Waveforms for enable and disable test waveforms and measurement reference levels.

Commercial Switching Characteristics PALCE22V10 (continued)^[2, 7]

Parameter	Description	22V10-5		22V10-7		22V10-10		22V10-15		22V10-25		Unit
		Min.	Max.	Min.	Max.	Min.	Max.	Min.	Max.	Min.	Max.	
t _{S1}	Input or Feedback Set-Up Time	3		5		6		10		15		ns
t _{S2}	Synchronous Preset Set-Up Time	4		6		7		10		15		ns
t _H	Input Hold Time	0		0		0		0		0		ns
t _P	External Clock Period (t _{CO} + t _S)	7		10		12		20		30		ns
t _{WH}	Clock Width HIGH ^[6]	2.5		3		3		6		13		ns
t _{WL}	Clock Width LOW ^[6]	2.5		3		3		6		13		ns
f _{MAX1}	External Maximum Frequency (1/(t _{CO} + t _S)) ^[11]	143		100		76.9		55.5		33.3		MHz
f _{MAX2}	Data Path Maximum Frequency (1/(t _{WH} + t _{WL})) ^[6, 12]	200		166		142		83.3		35.7		MHz
f _{MAX3}	Internal Feedback Maximum Frequency (1/(t _{CF} + t _S)) ^[6, 13]	181		133		111		68.9		38.5		MHz
t _{CF}	Register Clock to Feedback Input ^[6, 14]		2.5		2.5		3		4.5		13	ns
t _{AW}	Asynchronous Reset Width	8		8		10		15		25		ns
t _{AR}	Asynchronous Reset Recovery Time	4		5		6		10		25		ns
t _{AP}	Asynchronous Reset to Registered Output Delay		7.5		12		13		20		25	ns
t _{SPR}	Synchronous Preset Recovery Time	4		6		8		10		15		ns
t _{PR}	Power-up Reset Time ^[6, 15]	1		1		1		1		1		μs

Military and Industrial Switching Characteristics PALCE22V10 ^[2, 7]

Parameter	Description	22V10-10		22V10-15		22V10-25		Unit
		Min.	Max.	Min.	Max.	Min.	Max.	
t _{PD}	Input to Output Propagation Delay ^[8]	3	10	3	15	3	25	ns
t _{EA}	Input to Output Enable Delay ^[9]		10		15		25	ns
t _{ER}	Input to Output Disable Delay ^[10]		10		15		25	ns
t _{CO}	Clock to Output Delay ^[8]	2	7	2	8	2	15	ns
t _{S1}	Input or Feedback Set-up Time	6		10		18		ns
t _{S2}	Synchronous Preset Set-up Time	7		10		18		ns
t _H	Input Hold Time	0		0		0		ns
t _P	External Clock Period (t _{CO} + t _S)	12		20		33		ns
t _{WH}	Clock Width HIGH ^[6]	3		6		14		ns
t _{WL}	Clock Width LOW ^[6]	3		6		14		ns
f _{MAX1}	External Maximum Frequency (1/(t _{CO} + t _S)) ^[11]	76.9		50.0		30.3		MHz
f _{MAX2}	Data Path Maximum Frequency (1/(t _{WH} + t _{WL})) ^[6, 12]	142		83.3		35.7		MHz

Notes:

11. This specification indicates the guaranteed maximum frequency at which a state machine configuration with external feedback can operate.
12. This specification indicates the guaranteed maximum frequency at which the device can operate in data path mode.
13. This specification indicates the guaranteed maximum frequency at which a state machine configuration with internal only feedback can operate.
14. This parameter is calculated from the clock period at f_{MAX} internal (1/f_{MAX3}) as measured (see Note above) minus t_S.
15. The registers in the PALCE22V10 have been designed with the capability to reset during system power-up. Following power-up, all registers will be reset to a logic LOW state. The output state will depend on the polarity of the output buffer. This feature is useful in establishing state machine initialization. To insure proper operation, the rise in V_{CC} must be monotonic and the timing constraints depicted in Power-Up Reset Waveform must be satisfied.

Military and Industrial Switching Characteristics PALCE22V10 (continued)^[2, 7]

Parameter	Description	22V10-10		22V10-15		22V10-25		Unit
		Min.	Max.	Min.	Max.	Min.	Max.	
f_{MAX3}	Internal Feedback Maximum Frequency $(1/(t_{CF} + t_S))^{[6, 13]}$	111		68.9		32.2		MHz
t_{CF}	Register Clock to Feedback Input ^[6, 14]		3		4.5		13	ns
t_{AW}	Asynchronous Reset Width	10		15		25		ns
t_{AR}	Asynchronous Reset Recovery Time	6		12		25		ns
t_{AP}	Asynchronous Reset to Registered Output Delay		12		20		25	ns
t_{SPR}	Synchronous Preset Recovery Time	8		20		25		ns
t_{PR}	Power-up Reset Time ^[6, 15]	1		1		1		μ s

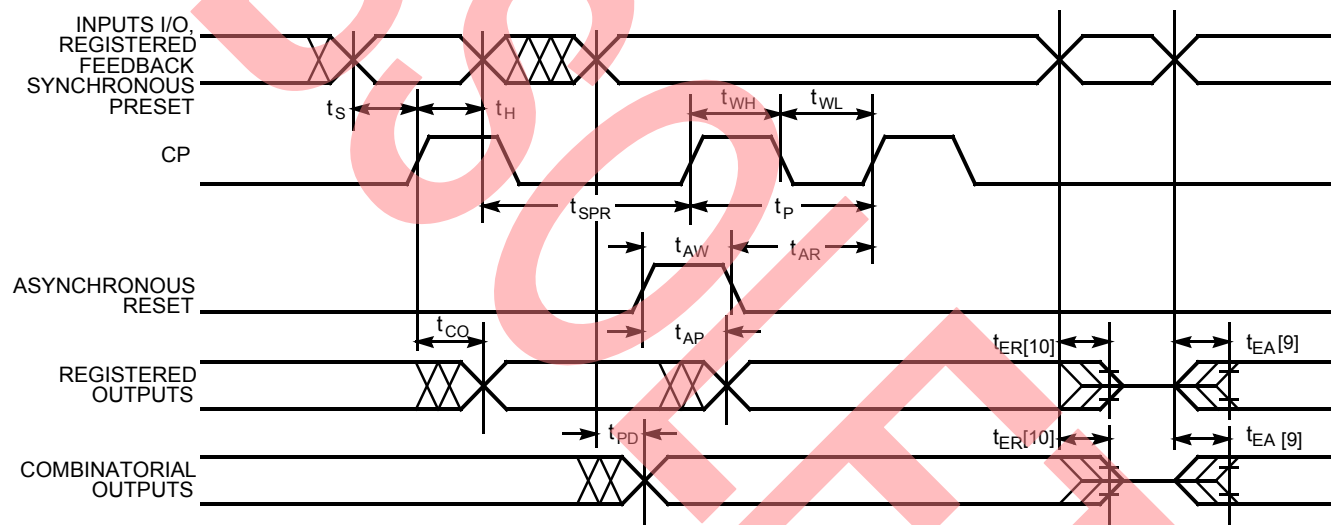
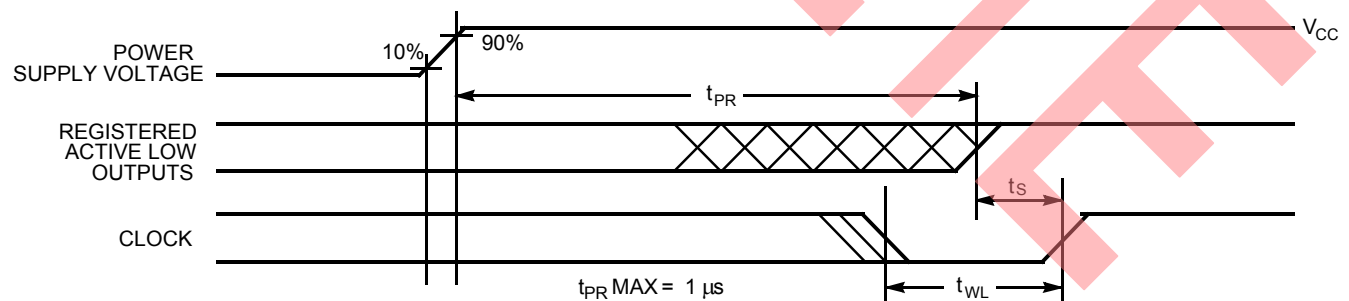
Switching Waveforms

Power-Up Reset Waveform^[15]

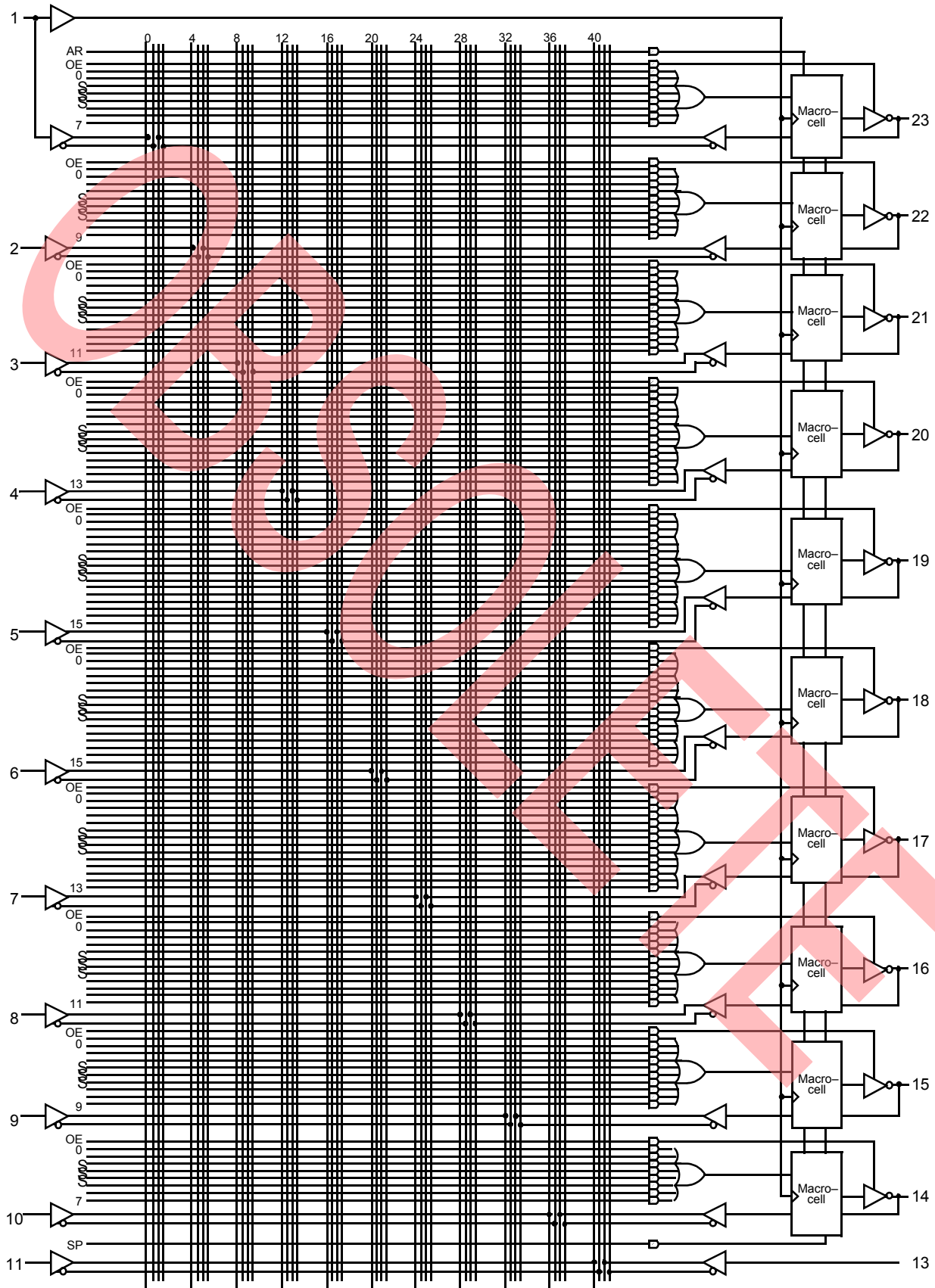
Functional Logic Diagram for PALCE22V10



Ordering Information

I _{CC} (mA)	t _{PD} (ns)	t _S (ns)	t _{CO} (ns)	Ordering Code	Package Name	Package Type	Operating Range
130	5	3	4	PALCE22V10-5PC	P13	24-lead (300 MIL) Molded DIP	Commercial
				PALCE22V10-5JC	J64	28-lead Plastic Leaded Chip Carrier	
130	7.5	5	5	PALCE22V10-7JC	J64	28-lead Plastic Leaded Chip Carrier	Commercial
				PALCE22V10-7PC	P13	24-lead (300-Mil) Molded DIP	
90	10	6	7	PALCE22V10-10JC	J64	28-lead Plastic Leaded Chip Carrier	Commercial
				PALCE22V10-10PC	P13	24-lead (300-Mil) Molded DIP	
150	10	6	7	PALCE22V10-10JI	J64	28-lead Plastic Leaded Chip Carrier	Industrial
				PALCE22V10-10PI	P13	24-lead (300-Mil) Molded DIP	
				PALCE22V10-10LMB 5962-89841063X	L64	28-Square Leadless Chip Carrier	Military
				PALCE22V10-10KMB 5962-8984106KX	K73	24-lead Rectangular Cerpack	
90	15	10	8	PALCE22V10-10DMB 5962-8984106LX	D14	24-lead (300 MIL) CerDIP	
				PALCE22V10-15JC	J64	28-lead Plastic Leaded Chip Carrier	Commercial
120	15	10	8	PALCE22V10-15PC	P13	24-lead (300-Mil) Molded DIP	
				PALCE22V10-15KMB 5962-8984102KX	K73	24-lead Rectangular Cerpack	Military
				PALCE22V10-15KMB 5962-8984103KX	K73	24-lead Rectangular Cerpack	
				PALCE22V10-15KMB 5962-8984105KX	K73	24-lead Rectangular Cerpack	
				PALCE22V10-15DMB 5962-8984102LX	D14	24-lead (300 MIL) CerDIP	
				PALCE22V10-15DMB 5962-8984103LX	D14	24-lead (300 MIL) CerDIP	
				PALCE22V10-15LMB 5962-89841033X	L64	28-Square Leadless Chip Carrier	
				PALCE22V10-15LMB 5962-89841053X	L64	28-Square Leadless Chip Carrier	
90	25	15	15	PALCE22V10-15JC	J64	28-lead Plastic Leaded Chip Carrier	
				PALCE22V10-15PC	P13	24-lead (300-Mil) Molded DIP	
120	25	15	15	PALCE22V10-25LMB 5962-89841043X	L64	28-square Leadless Chip Carrier	Military

MILITARY SPECIFICATIONS Group A Subgroup Testing
DC Characteristics

Parameter	Subgroups
V _{OH}	1, 2, 3
V _{OL}	1, 2, 3
V _{IH}	1, 2, 3
V _{IL}	1, 2, 3
I _{Ix}	1, 2, 3
I _{OZ}	1, 2, 3

DC Characteristics

Parameter	Subgroups
I _{CC}	1, 2, 3

Switching Characteristics

Parameter	Subgroups
t _{PD}	9, 10, 11
t _{CO}	9, 10, 11
t _S	9, 10, 11
t _H	9, 10, 11

Package Diagrams

24-lead (300-mil) CerDIP D14
MIL-STD-183D-9 Config.A

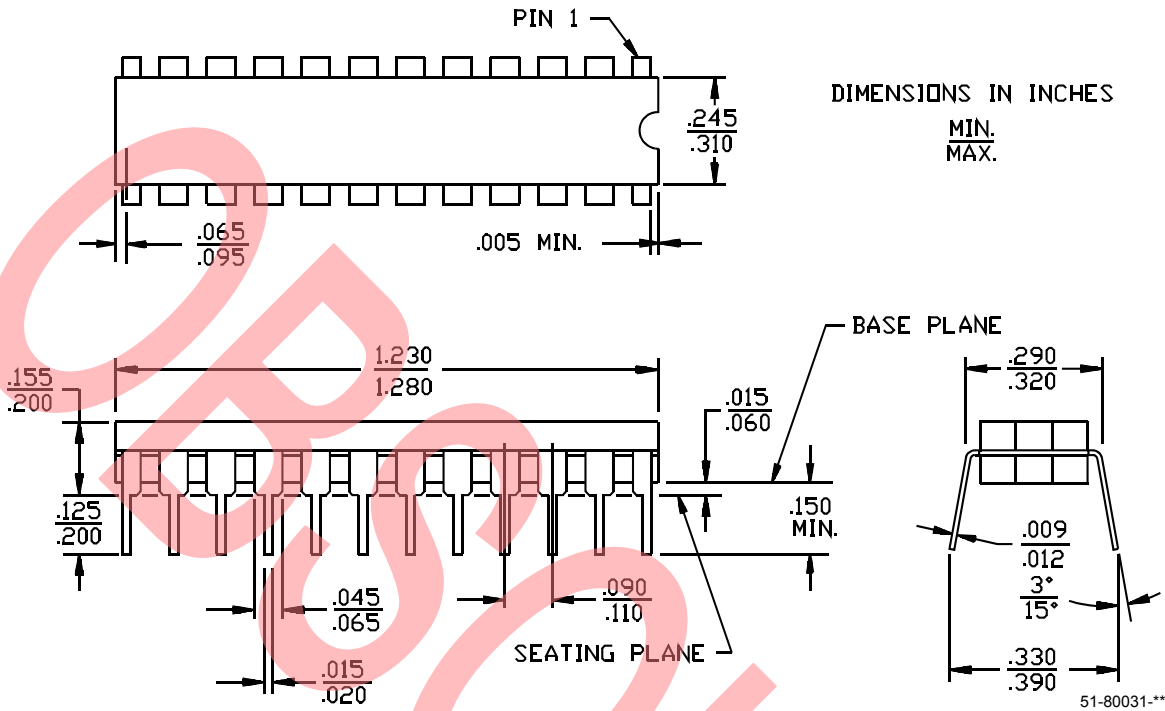

28-lead Plastic Leaded Chip Carrier J64

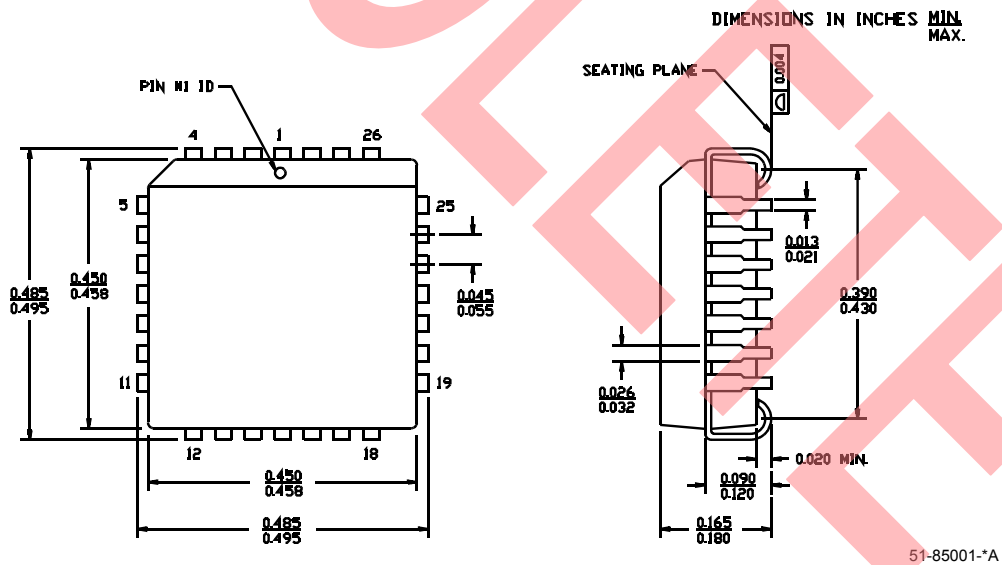

Package Diagrams (continued)

24-Lead Rectangular Cerpack K73
MIL-STD-1835 F-6 Config. A

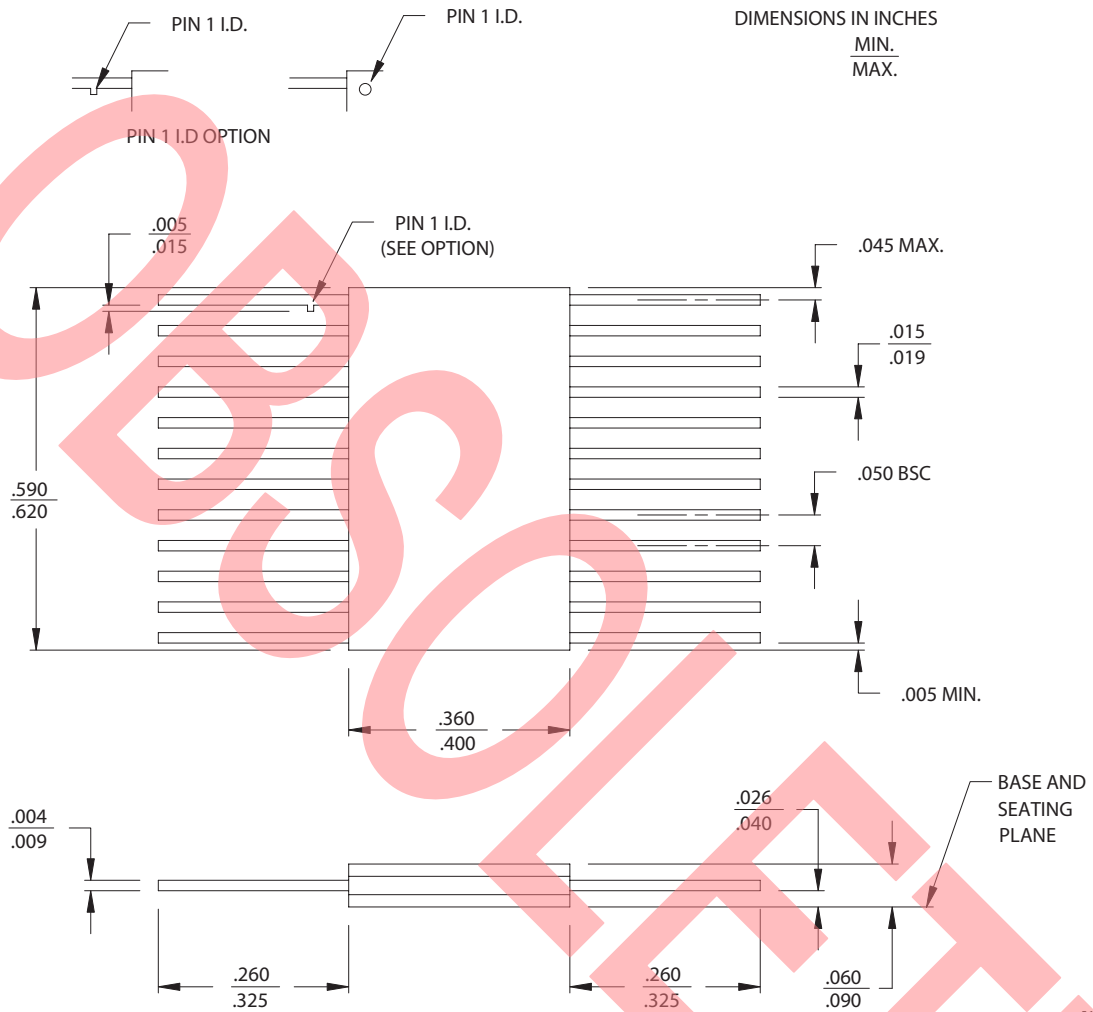

Package Diagrams (continued)

28-Square Leadless Chip Carrier L64
MIL-STD-1835 C-4

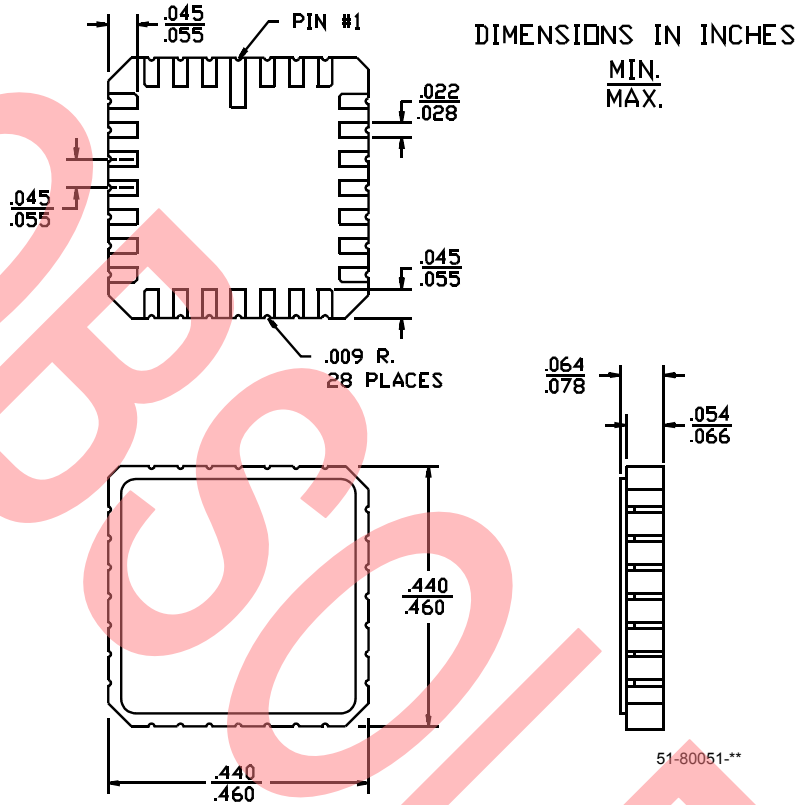

Ultra37000 is a trademark of Cypress Semiconductor Corporation. PAL is a registered trademark of Advanced Micro Devices. All product and company names mentioned in this document are the trademarks of their respective holders.



Document History Page

Document Title: PALCE22V10 Flash-erasable Reprogrammable CMOS PAL® Device				
Document Number: 38-03027				
REV.	ECN NO.	Issue Date	Orig. of Change	Description of Change
**	106372	07/11/01	SZV	Change from Spec Number: 38-00447 to 38-03027
*A	114640	06/25/02	OOR	Added a note on the title page referring all new designs to this device Added Military Part Numbers
*B	213375	See ECN	FSG	Added note to title page: "Use Ultra37000 For All New Designs"
*C	2675372	See ECN	AMV	Sunset Review: Obsolete product

OBsolete