

Buffered H-Bridge

FEATURES

- 1.0-A H-Bridge
- 500-kHz Switching Rate
- Shoot-Through Limited
- TTL Compatible Inputs
- 3.8- to 13.2-V Operating Range
- Surface Mount Packaging

APPLICATIONS

- VCM Driver
- Brushed Motor Driver
- Stepper Motor Driver
- Power Converter
- Optical Disk Drives
- Power Supplies
- High Performance Servo

DESCRIPTION

The Si9987 is an integrated, buffered H-bridge with TTL compatible inputs and the capability of delivering a continuous 1.0 A @ $V_{DD} = 5.0$ V (room temperature) at switching rates up to 500 kHz. Internal logic prevents the upper and lower outputs from being turned on simultaneously. Unique input codes allow both outputs to be forced low (for braking) or

forced to a high impedance level.

The Si9987 is available in an 8-Pin SOIC package, specified to operate over a voltage range of 3.8 V to 13.2 V, and the commercial temperature range of 0 to 70°C (C suffix) and -40 to 85°C (D suffix). The Si9987 is available in lead free.

FUNCTIONAL BLOCK DIAGRAM, PIN CONFIGURATION AND TRUTH TABLE

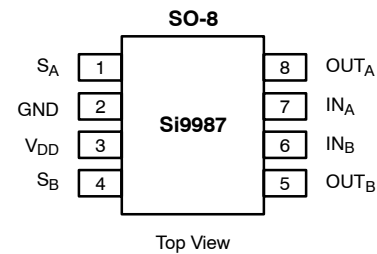

TRUTH TABLE			
IN _A	IN _B	OUT _A	OUT _B
1	0	1	0
0	1	0	1
0	0	0	0
1	1	HiZ	HiZ

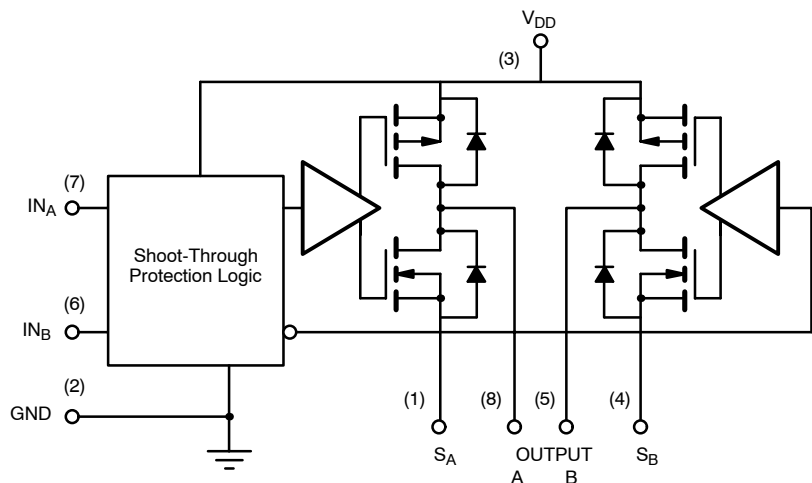

ORDERING INFORMATION		
Part Number	Temperature Range	Package
Si9987CY-T1	0 to 70°C	Tape and Reel
Si9987DY-T1	-40 to 85°C	
Si9987CY-T1—E3	0 to 70°C	Lead Free Tape and Reel
Si9987DY-T1—E3	-40 to 85°C	
Si9987CY	0 to 70°C	Bulk (tubes)
Si9987DY	-40 to 85°C	



ABSOLUTE MAXIMUM RATINGS^a

Voltage on any pin with respect to ground	-0.3 V to $V_{DD} + 0.3$ V
Voltage on pins 5, 8 with respect to GND	-1 V to $V_{DD} + 1$ V
Voltage on pins 1, 4	-0.3 V to GND +1 V
Maximum V_{DD}	15 V
Peak Output Current	1.5 A
Storage Temperature	-65 to 150°C
Maximum Junction Temperature (T_J)	150°C
Power Dissipation ^b	1 W
θ_{JA}	100°C/W

Continuous I_{OUT} Current ($T_J = 135^\circ\text{C}$) ^c	
$T_A = 25^\circ\text{C}$	± 1.02 A
$T_A = 70^\circ\text{C}$	± 0.75 A
$T_A = 85^\circ\text{C}$	± 0.65 A
Operating Temperature Range	
Si9987CY	0 to 70°C
Si9987DY	-40 to 85°C

Notes

- Device mounted with all leads soldered or welded to PC board.
- Derate 10 mW/°C above 25°C.
- $T_J = T_A + (P_D \times \theta_{JA})$, P_D = Power Dissipation.

RECOMMENDED OPERATING RANGE

V_{DD}	3.8 V to 13.2 V
Maximum Junction Temperature (T_J)	135°C

SPECIFICATIONS						
Parameter	Symbol	Test Conditions Unless Specified $V_{DD} = 3.8$ to 13.2 V S_A @ GND, S_B @ GND	Limits			Unit
			Min ^a	Typ ^b	Max ^a	
Input						
Input Voltage High	V_{INH}		2			V
Input Voltage Low	V_{INL}				1	
Input Current with Input Voltage High	I_{INH}	$V_{IN} = 2$ V			1	μA
Input Current with Input Voltage Low	I_{INL}	$V_{IN} = 0$ V	-1			
Output						
Output Voltage High ^c	V_{OUTH}	$I_{OUT} = -1$ A	$V_{DD} = 10.8$ V	10.40	10.56	V
			$V_{DD} = 4.5$ V	4.00	4.20	
		$I_{OUT} = -500$ mA	$V_{DD} = 10.8$ V	10.60	10.68	
$V_{DD} = 4.5$ V	4.25		4.35			
		$I_{OUT} = -300$ mA, $V_{DD} = 3.8$ V	3.63	3.70		
Output Voltage Low ^c	V_{OUTL}	$I_{OUT} = 1$ A	$V_{DD} = 10.8$ V		0.24	
			$V_{DD} = 4.5$ V		0.30	0.50
		$I_{OUT} = 500$ mA	$V_{DD} = 10.8$ V		0.12	0.20
			$V_{DD} = 4.5$ V		0.15	0.25
		$I_{OUT} = 300$ mA, $V_{DD} = 3.8$ V		0.10	0.17	
Output Leakage Current Low	I_{OLL}	$I_{NA} = I_{NB} \geq 2$ V, $V_{OUT} = V_{DD} = 13.2$ V		0	10	μA
Output Leakage Current High	I_{OLH}	$V_{OUT} = 0$, $V_{DD} = 13.2$ V	-10	0		
Output V Clamp High	V_{CLH}	$I_{NA} = I_{NB} \geq 2$ V	$I_{OUT} = 100$ mA	$V_{DD} + 0.7$	$V_{DD} + 0.9$	V
Output V Clamp Low	V_{CLL}		$I_{OUT} = -100$ mA	-0.9	-0.7	
Supply						
V_{DD} Supply Current	I_{DD}	$I_N = 100$ kHz, $V_{DD} = 5.5$ V		1.8	2.5	mA
		$I_{NA} = I_{NB} = 4.5$ V, $V_{DD} = 5.5$ V		75	125	μA
Dynamic						
Propagation Delay Time	T_{PLH}	$V_{DD} = 5$ V		300		nS
	T_{PHL}			100		

Notes

- The algebraic convention whereby the most negative value is a minimum and the most positive a maximum, is used in this data sheet.
- Typical values are for DESIGN AID ONLY, not guaranteed nor subject to production testing.
- Maximum value measured at $T_J = 135^\circ\text{C}$. Typical value measured at $T_J = T_A = 25^\circ\text{C}$ (pulse width ≤ 300 μsec , duty cycle $\leq 2\%$).

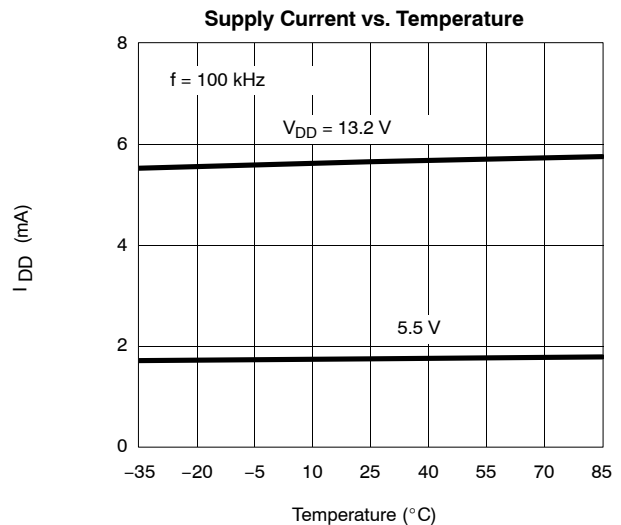
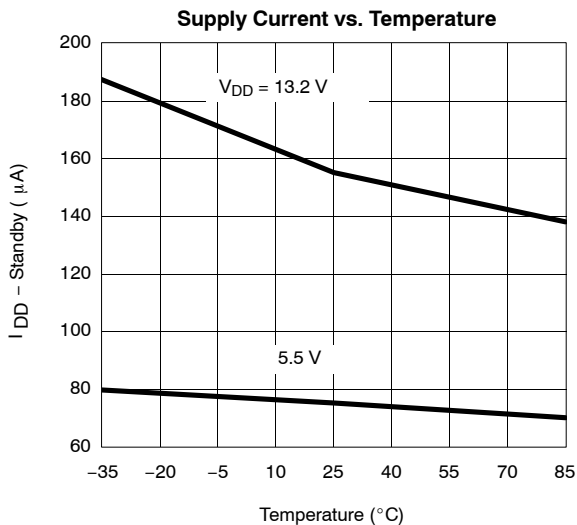
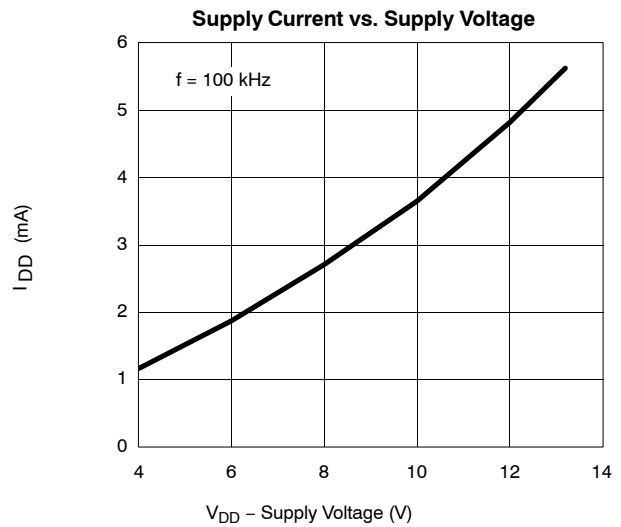
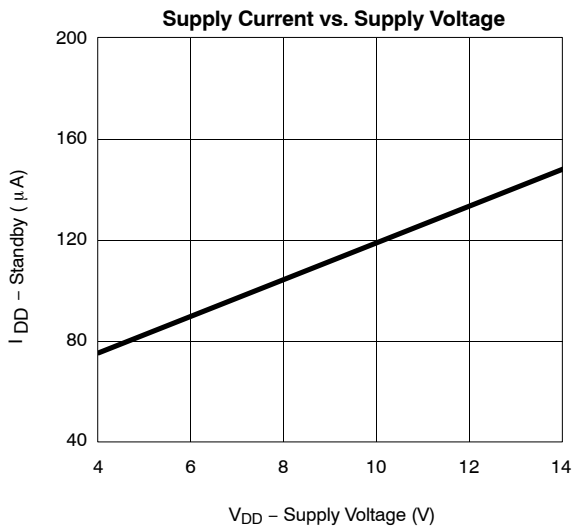
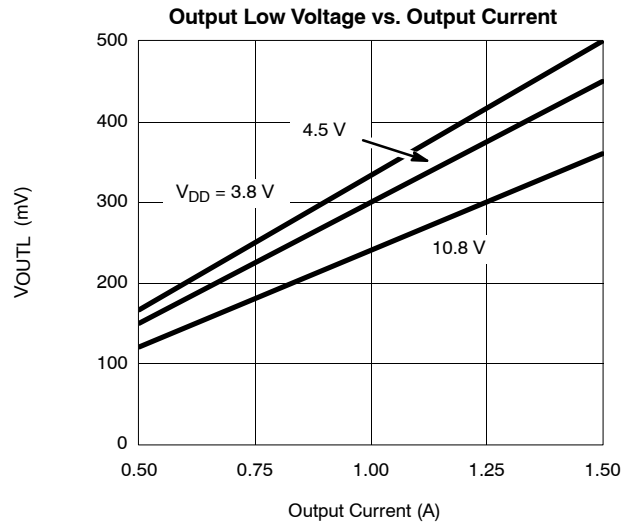
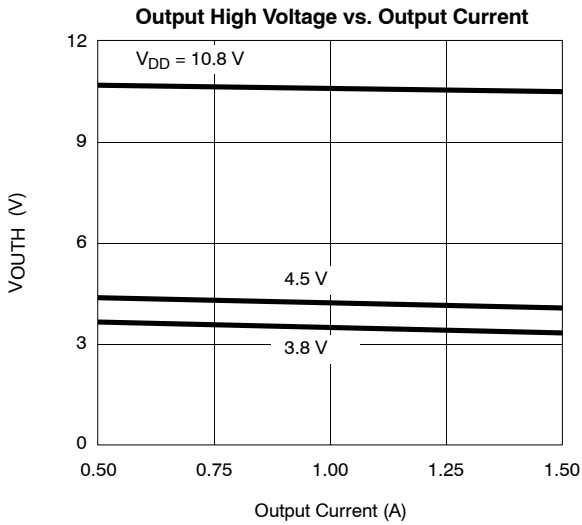
TYPICAL CHARACTERISTICS (25°C UNLESS NOTED)

TYPICAL CHARACTERISTICS (25 °C UNLESS NOTED)

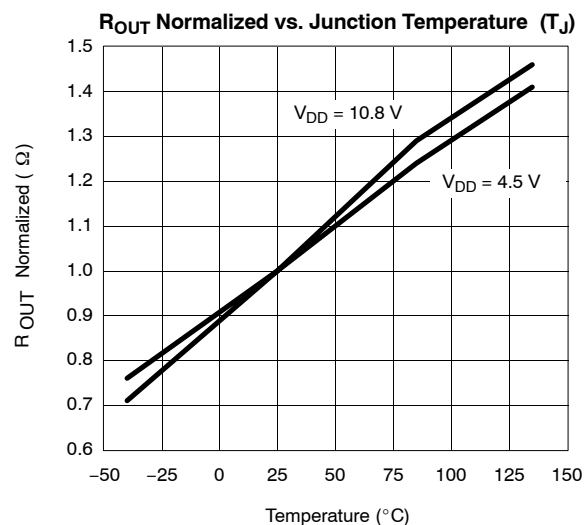
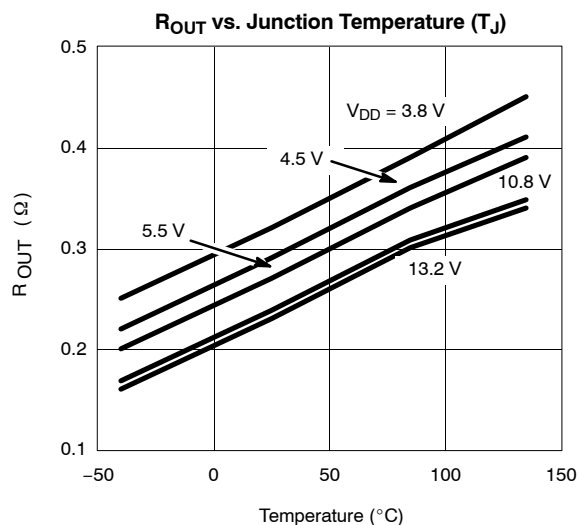
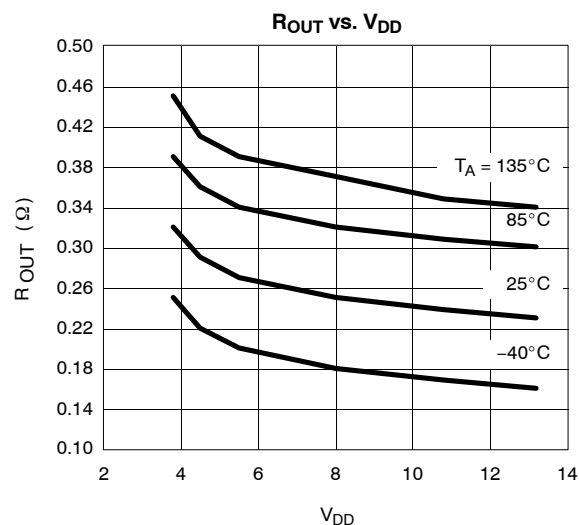
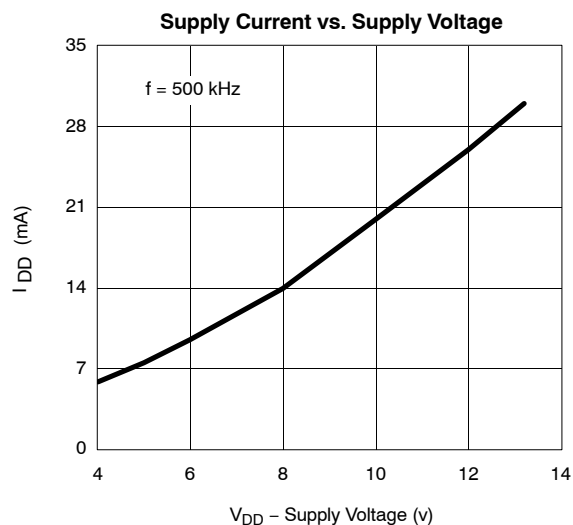
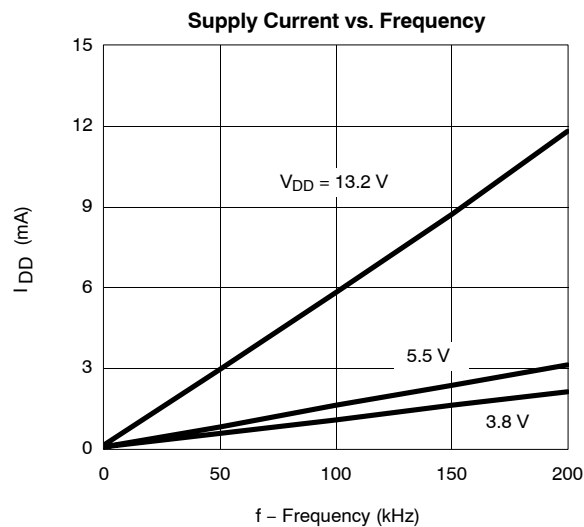
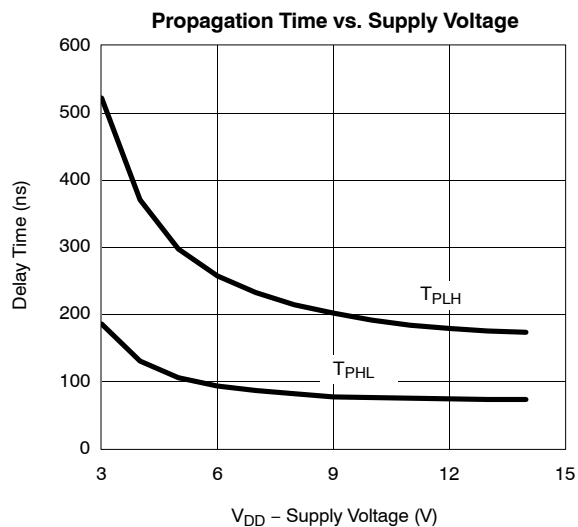



Disclaimer

All product specifications and data are subject to change without notice.

Vishay Intertechnology, Inc., its affiliates, agents, and employees, and all persons acting on its or their behalf (collectively, "Vishay"), disclaim any and all liability for any errors, inaccuracies or incompleteness contained herein or in any other disclosure relating to any product.

Vishay disclaims any and all liability arising out of the use or application of any product described herein or of any information provided herein to the maximum extent permitted by law. The product specifications do not expand or otherwise modify Vishay's terms and conditions of purchase, including but not limited to the warranty expressed therein, which apply to these products.

No license, express or implied, by estoppel or otherwise, to any intellectual property rights is granted by this document or by any conduct of Vishay.

The products shown herein are not designed for use in medical, life-saving, or life-sustaining applications unless otherwise expressly indicated. Customers using or selling Vishay products not expressly indicated for use in such applications do so entirely at their own risk and agree to fully indemnify Vishay for any damages arising or resulting from such use or sale. Please contact authorized Vishay personnel to obtain written terms and conditions regarding products designed for such applications.

Product names and markings noted herein may be trademarks of their respective owners.