

Slotted Optical Switch

OPB610, OPB611, OPB620, OPB621



Features:

- Non-contact switching
- Printed circuit board mounting
- Enhanced signal to noise ratio
- PIN photodiode sensor for high speed (OPB611, OPB621)
- Lead centers: 0.275" (OPB61_) / 0.320" (OPB62_)
- Gap: 0.150" (OPB61_) / 0.190" (OPB62_)

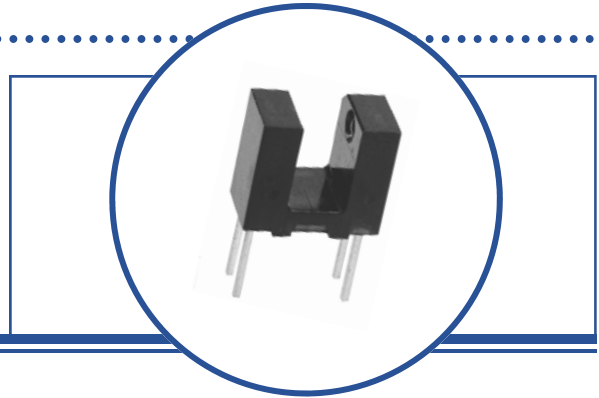

Description:

The **OPB610** and **OPB620** slotted optical switches consist of an infrared emitting diode and an NPN silicon phototransistor with an enhanced low current roll-off to improve contrast ratio and immunity to background irradiance.

The **OPB611**, **OPB621** slotted optical switch consists of an infrared emitting diode and a PIN photodiode with a polysulfone housing that is opaque to visible light, but transmissive to infrared. The low t_r/t_f of the PIN photodiode is ideal for high-speed operation. The sensitivity to ambient radiation is minimized.

Custom electrical, wire and cabling and connectors are available. Contact your local representative or OPTEK for more information.

Applications:

- Non-contact reflective object sensor
- Assembly line automation
- Machine automation
- Machine safety
- End of travel sensor
- Door sensor

Ordering Information

Part Number	LED Peak Wavelength	Sensor	Slot Width / Depth	Aperture Emitter / Sensor	Lead Length / Spacing
OPB610	890 nm	Rbe Transistor	0.150" / 0.240"	0.06" / 0.06"	0.100" / 0.275"
OPB611		Diode			
OPB620	890 nm	Rbe Transistor	0.190" / 0.285"	0.06" / 0.06"	0.100" / 0.320"
OPB621		Diode			

OPB610, OPB611

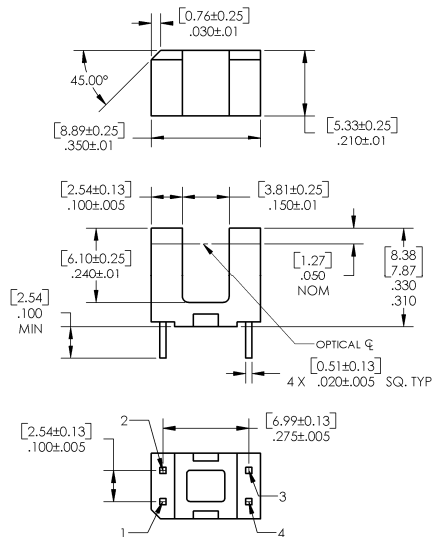

OPB620, OPB621

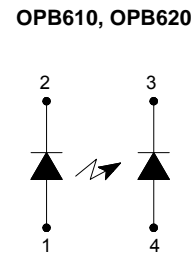
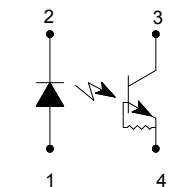
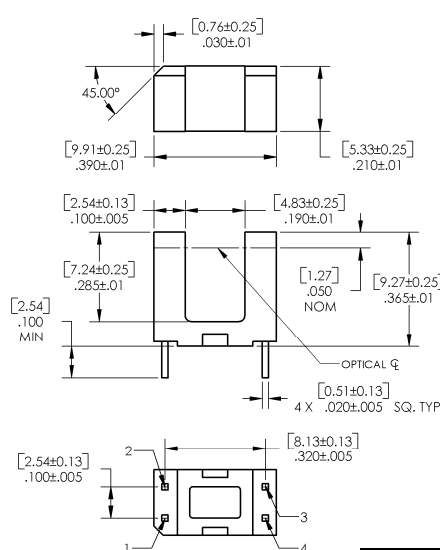

RoHS

DIMENSIONS ARE IN: [MILLIMETERS]
INCHES

OPTEK reserves the right to make changes at any time in order to improve design and to supply the best product possible.

Pin #	LED	Pin #	Transistor / Diode
1	Anode	4	Emitter / Anode
2	Cathode	3	Collector / Cathode

Absolute Maximum Ratings ($T_A=25^{\circ}\text{C}$ unless otherwise noted)

Storage and Operating Temperature Range	-40°C to +100° C
Lead Soldering Temperature [1/16 inch (1.6mm) from the case for 5 sec. with soldering iron] ⁽¹⁾	260° C

Input Diode

Forward DC Current	50 mA
Peak Forward Current (1 μs pulse width, 300 pps)	3 A
Reverse DC Voltage	3 V
Power Dissipation ⁽²⁾	100 mW

Output Photodiode (OPB621)

Reverse Breakdown Voltage	60 V
Power Dissipation	100 mW

Output Phototransistor (OPB610, OPB620)

Collector-Emitter Voltage	24 V
Emitter-Collector Voltage	10 mA
Collector DC Current	30 mA
Power Dissipation ⁽³⁾	200 mW

Electrical Characteristics ($T_A = 25^{\circ}\text{C}$ unless otherwise noted)

SYMBOL	PARAMETER	MIN	TYP	MAX	UNITS	TEST CONDITIONS
--------	-----------	-----	-----	-----	-------	-----------------

Input Diode (See OP240 for additional information)

V_F	Forward Voltage OPB610, OPB620 OPB621	- 1.15	- -	1.6 1.45	V V	$I_F = 10\text{ mA}$ $I_F = 10\text{ mA}$
I_R	Reverse Current	-	-	100	μA	$V_R = 3\text{ V}$

Output Phototransistor (OPB610, OPB620) (See OP505 for additional information)

$V_{(BR)CEO}$	Collector-Emitter Breakdown Voltage	24	-	-	V	$I_C = 100\ \mu\text{A}$
BV_{ECO}	Emitter-Collector Breakdown Voltage	0.4	-	-	V	$I_{CE} = 100\ \mu\text{A}$
I_{CEO}	Collector-Emitter Dark Current	-	-	100	nA	$V_{CE} = 5\text{ V}$

Output Photodiode (OPB611, OPB621) (See OP999 for additional information)

I_D	Dark Current	-	-	65	nA	$V_R = 30\text{ V}, E_E = 0\text{ mW}$
$V_{(BR)R}$	Reverse Breakdown Voltage	60	-	-	V	$I_R = 100\ \mu\text{A}, E_E = 0\text{ mW}$
V_F	Forward Voltage	-	-	1.0	V	$I_F = 1\text{ mA}, E_E = 0\text{ mW}$

Combined

V_{SAT}	Collector-Emitter Saturation Voltage OPB610, OPB620	-	-	0.4	V	$I_F = 5\text{ mA}, I_C = 100\ \mu\text{A}$
$I_{C(ON)}$	On-State Collector/Diode Current OPB610, OPB620 OPB611, OPB621	1 9	- -	- 90	mA μA	$I_F = 5\text{ mA}, V_{CE} = 5\text{ V}$ (gap unblocked) $V_R = 5\text{ V}, I_F = 20\text{ mA}$ (gap unblocked)

Notes:

- (1) RMA flux is recommended. Duration can be extended to 10 seconds maximum when flow soldering. A maximum of 20 grams force may be applied to leads when soldering.
- (2) Derate linearly 1.33 mW/°C above 25 ° C.
- (3) Derate linearly 2.0 mW/°C above 25 ° C.

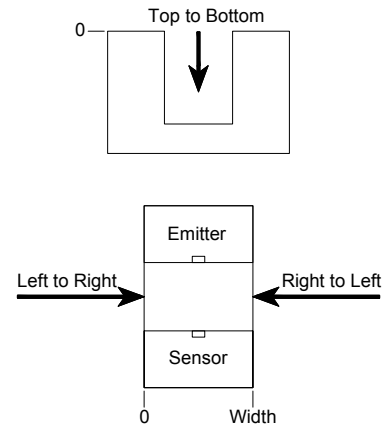
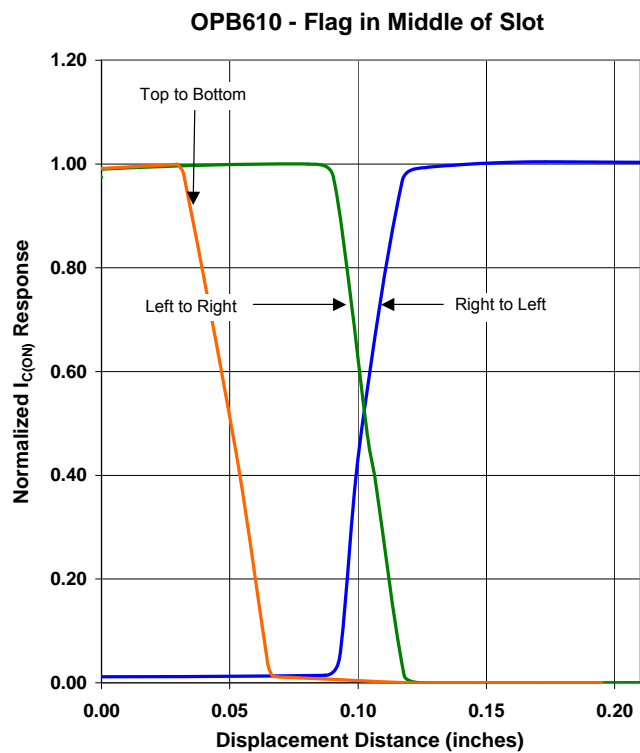
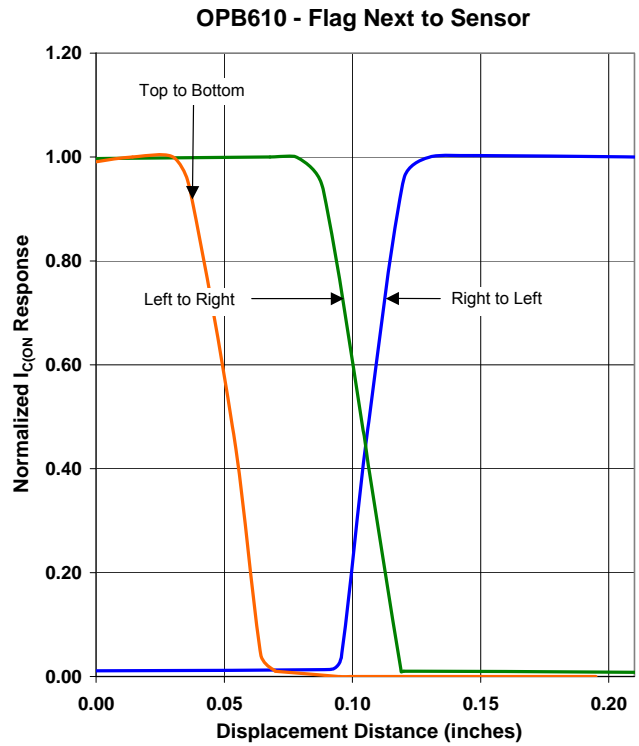
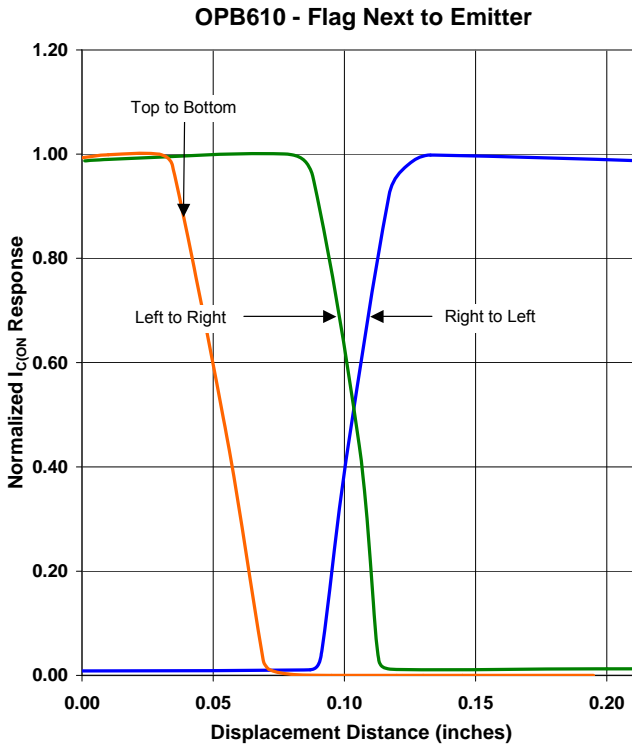

OPTEK reserves the right to make changes at any time in order to improve design and to supply the best product possible.

OPB620 - Flag Next to Emitter

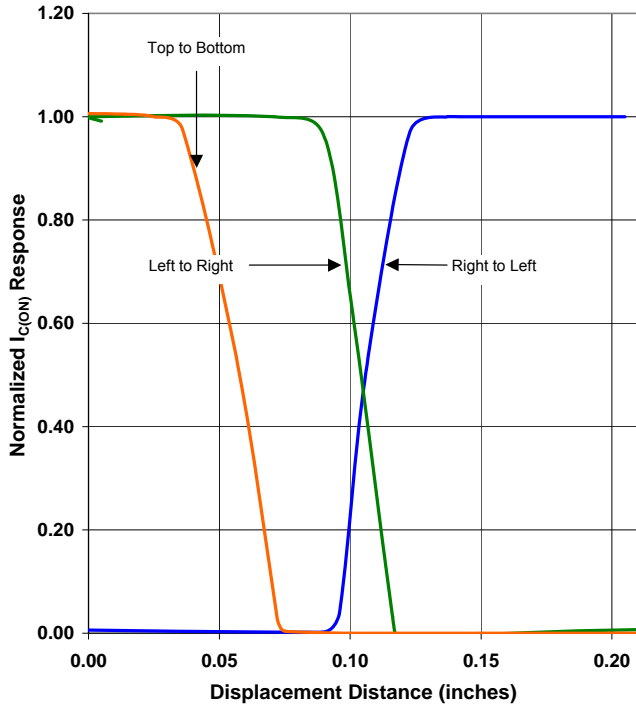

OPB620 - Flag Next to Sensor

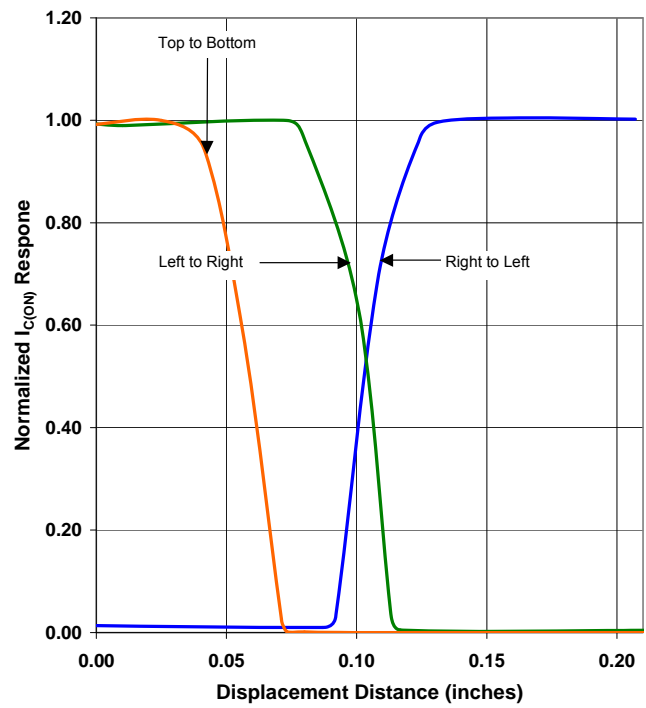

OPB620 - Flag in Middle of Slot

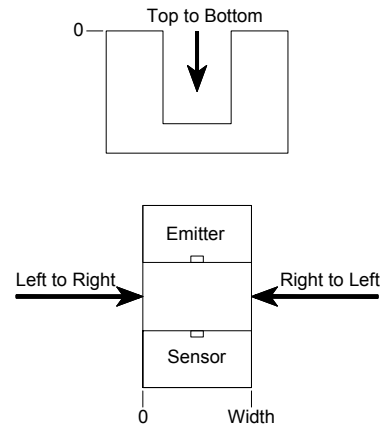
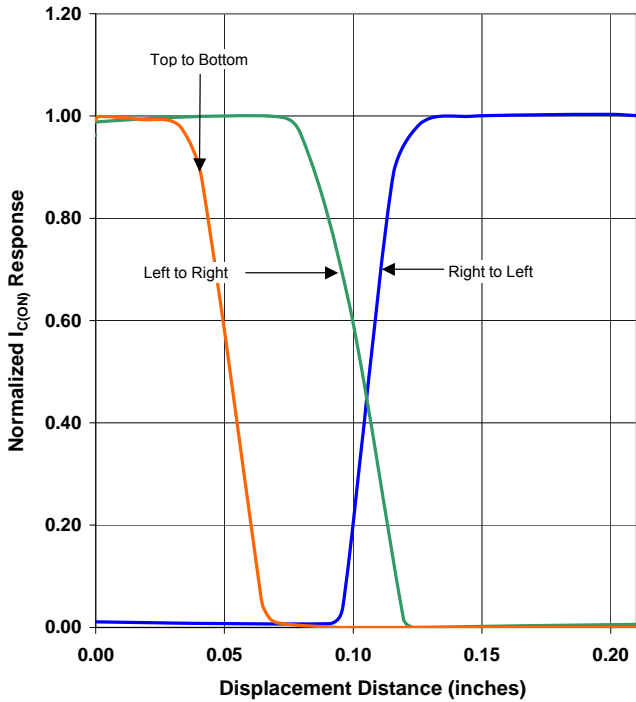

OPTEK reserves the right to make changes at any time in order to improve design and to supply the best product possible.