

Reflective Object Sensors

Types OPB740W, OPB741W, OPB742W, OPB743W, OPB744W

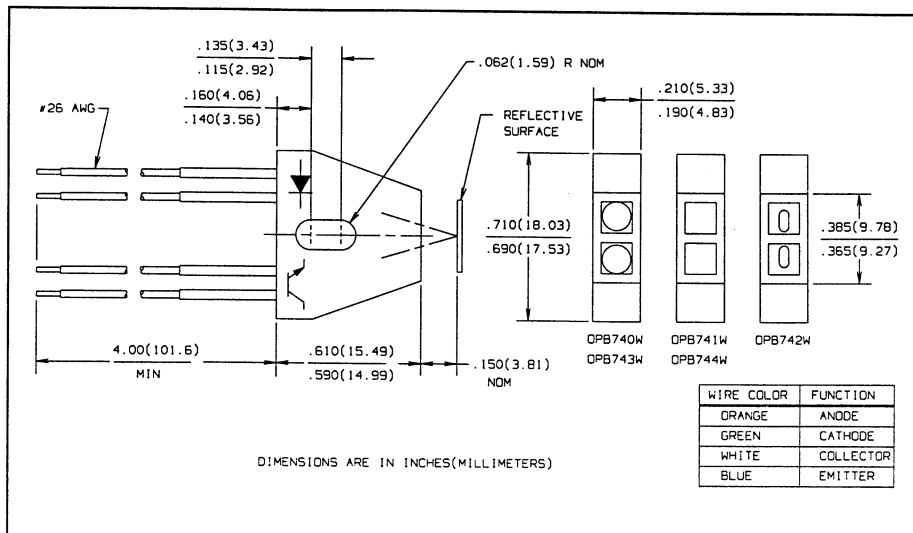
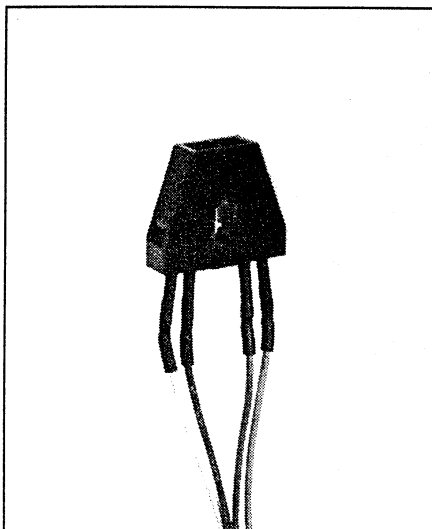

Features

- Focused for maximum sensitivity
- Phototransistor output
- Low cost plastic housing
- 4.0" min 26 AWG wire leads

Description

The OPB740W through OPB744W reflective object sensors each consist of an infrared emitting diode and an NPN silicon phototransistor mounted side by side on converging optical axes in a black plastic housing. Various options include choice of no windows, blue polysulfone windows for dust protection or opaque windows with offset openings for improved resolution. Available with PC board mounting as OPB740/OPB744 series.

The photosensor responds to radiation from the emitter only when a reflective object passes within its field of view.

Absolute Maximum Ratings (TA = 25° C unless otherwise noted)

Storage and Operating Temperature Range -40° C to +80° C
 Lead Soldering Temperature [1/16 inch (1.6 mm) from case for 5 sec. with soldering iron]. 240° C⁽¹⁾

Input Diode

Continuous Forward Current 40 mA
 Reverse Voltage 2.0 V
 Power Dissipation 100 mW⁽²⁾

Output Photosensor

Collector-Emitter Voltage 30 V
 Emitter-Collector Voltage 5.0 V
 Power Dissipation 100 mW⁽²⁾

Notes:

- (1) RMA flux is recommended. Duration can be extended to 10 sec. max. when flow soldering.
- (2) Derate Linearly 1.82 mW/° C above 25° C.
- (3) d is distance from the assembly face to the reflective surface.
- (4) Reflective surface is Eastman Kodak neutral white test card with 90% diffuse reflectance as a reflecting surface. Reference: Eastman Kodak, Catalog #1257795.
- (5) Lower curve is based on calculated worst case condition rather than the conventional -2σ limit.
- (6) Crosstalk is the photocurrent measured with current to the input diode & no reflecting surface.
- (7) All parameters tested using pulse technique.

DESCRIPTION

OPB740W	No windows
OPB741W	Blue windows
OPB742W	Offset windows
OPB743W	No windows
OPB744 W	Blue windows

Types OPB740W, OPB741W, OPB742W, OPB743W, OPB744W

Electrical Characteristics ($T_A = 25^\circ\text{C}$ unless otherwise noted)

REFLECTIVE OBJECT SENSORS

SYMBOL	PARAMETER	MIN	MAX	UNITS	TEST CONDITIONS
Input Diode					
V_F	Forward Voltage		1.70	V	$I_F = 40\text{ mA}$
I_R	Reverse Current		100	μA	$V_R = 2.0\text{ V}$
Output Phototransistor					
$V_{(BR)CEO}$	Collector-Emitter Breakdown Voltage	30		V	$I_C = 100\ \mu\text{A}$
$V_{(BR)ECO}$	Emitter-Collector Breakdown Voltage	5.0		V	$I_E = 100\ \mu\text{A}$
I_{CEO}	Collector Dark Current		100	nA	$V_{CE} = 10\text{ V}, I_F = 0, E_e = 0$
Combined					
$I_{C(ON)}^{(3)(4)}$	On-State Collector Current	OPB740W/OPB741W OPB742W OPB743W/OPB744W	50 10 200	μA μA μA	$V_{CE} = 5\text{ V}, I_F = 40\text{ mA}, d = 0.15''$ $V_{CE} = 5\text{ V}, I_F = 40\text{ mA}, d = 0.15''$ $V_{CE} = 5\text{ V}, I_F = 40\text{ mA}, d = 0.15''$
$I_{CX}^{(6)}$	Crosstalk	OPB740W/OPB741W OPB742W OPB743W/OPB744W	10 100 20	μA nA μA	$V_{CE} = 5\text{ V}, I_F = 40\text{ mA}$ $V_{CE} = 5\text{ V}, I_F = 40\text{ mA}$ $V_{CE} = 5\text{ V}, I_F = 40\text{ mA}$

Typical Performance Curves

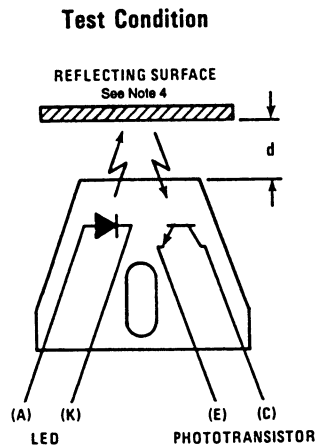
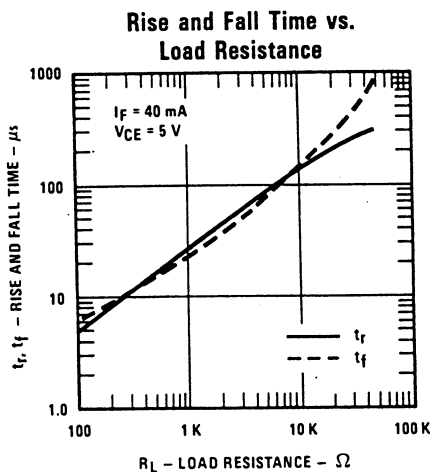
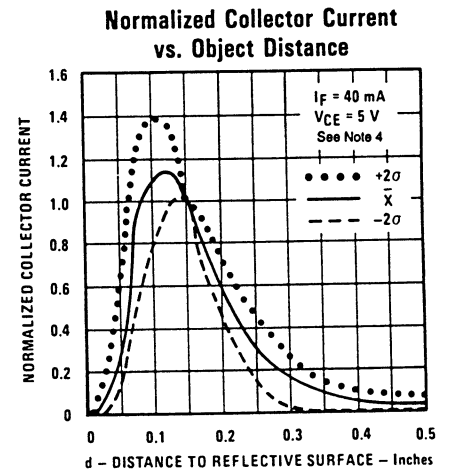
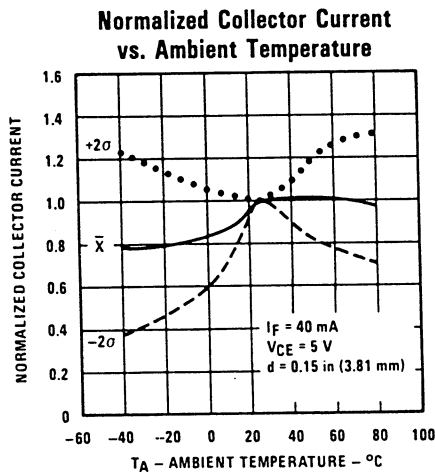
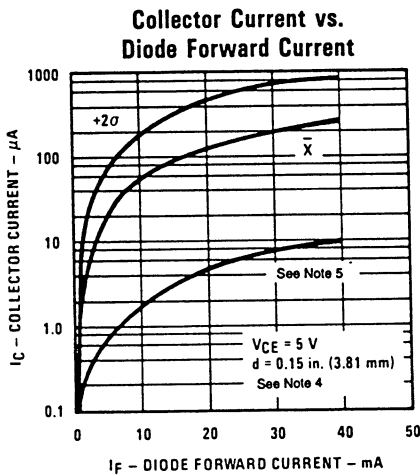

Optek reserves the right to make changes at any time in order to improve design and to supply the best product possible.
 Optek Technology, Inc. 1215 W. Crosby Road Carrollton, Texas 75006 (972)323-2200 Fax (972)323-2396