

Reflective Object Sensor

Types OPB700, OPB700AL

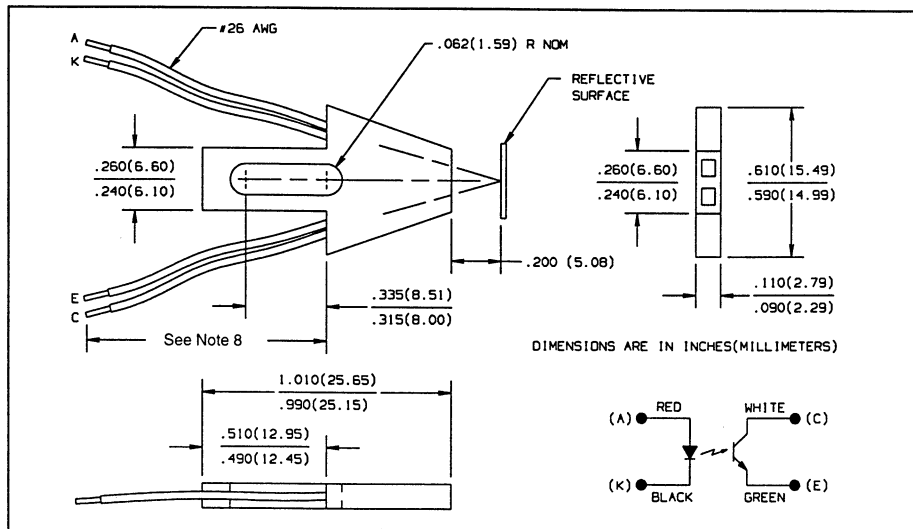
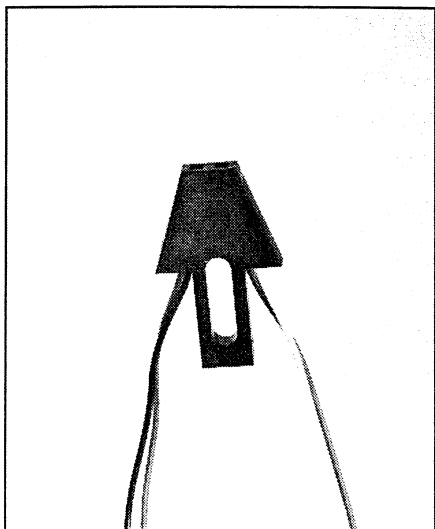

Features

- Phototransistor output
- Low profile to facilitate stacking
- Low cost plastic housing
- 4.0 inch minimum length lead wire (OPB700)
- 18.0 inch minimum length lead wire (OPB700AL)

Description

The OPB700 series sensor consists of an infrared emitting diode and an NPN silicon phototransistor, mounted "side-by-side" on converging optical axes, in a black plastic housing. The phototransistor responds to radiation from the emitter only when a reflective object passes within its field of view.

Leads are #26 AWG, teflon insulation, 4.0" minimum length (OPB700) or 18.0" minimum length (OPB700AL), stripped and tinned.

Absolute Maximum Ratings ($T_A = 25^\circ\text{C}$ unless otherwise noted)

Storage Temperature Range	-40°C to $+125^\circ\text{C}$
Operating Temperature Range	-40°C to $+100^\circ\text{C}$

Input Diode

Continuous Forward Current	100 mA
Reverse Voltage	2.0 V
Power Dissipation	80 mW ⁽¹⁾

Output Phototransistor

Collector-Emitter Voltage	25 V
Emitter-Collector Voltage	5.0 V
Power Dissipation	50 mW ⁽²⁾

Notes:

- (1) Derate linearly 1.07 mW/ $^\circ\text{C}$ above 25°C .
- (2) Derate linearly 0.67 mW/ $^\circ\text{C}$ above 25°C .
- (3) Measured using Eastman Kodak neutral white test card with 90% diffuse reflectance as a reflecting surface. Reference: Eastman Kodak, Catalog #1257795.
- (4) Crosstalk (I_{cx}) is the collector current measured with the indicated current in the input diode and with no reflecting surface.
- (5) d is the distance from the assembly head to the reflective surface.
- (6) Lower curve is based on a calculated worst case condition rather than the conventional -2σ limit.
- (7) All parameters tested using pulse technique.
- (8) 4.0" (101.6 mm) min for OPB700, 18.0" (457.2 mm) min for OPB700AL.

Type OPB700, OPB700AL

Electrical Characteristics ($T_A = 25^\circ\text{C}$ unless otherwise noted)

REFLECTIVE OBJECT SENSORS

SYMBOL	PARAMETER	MIN	MAX	UNITS	TEST CONDITIONS
Input Diode					
V_F	Forward Voltage		1.70	V	$I_F = 50\text{ mA}$
I_R	Reverse Current		100	μA	$V_R = 2.0\text{ V}$
Output Phototransistor					
$V_{(BR)CEO}$	Collector-Emitter Breakdown Voltage	25		V	$I_C = 100\ \mu\text{A}$
$V_{(BR)ECO}$	Emitter-Collector Breakdown Voltage	5.0		V	$I_E = 100\ \mu\text{A}$
I_{CEO}	Collector Dark Current		100	nA	$V_{CE} = 10\text{ V}, I_F = 0, E_e \leq 0.10\ \mu\text{W}/\text{cm}^2$
Combined					
$I_{C(ON)}$	On-State Collector Current	25		μA	$V_{CE} = 5\text{ V}, I_F = 40\text{ mA}, d = 0.200\text{ in. (5.08 mm)}$ ⁽³⁾⁽⁵⁾
I_{CX}	Crosstalk		2.0	μA	$V_{CE} = 5\text{ V}, I_F = 40\text{ mA}$ No Reflecting Surface ⁽⁴⁾
$V_{CE(SAT)}$	Collector-Emitter Saturation Voltage		0.40	V	$I_F = 40\text{ mA}, I_C = 10\ \mu\text{A}, d = 0.200\text{ in. (5.08 mm)}$ ⁽³⁾⁽⁵⁾

Typical Performance Curves

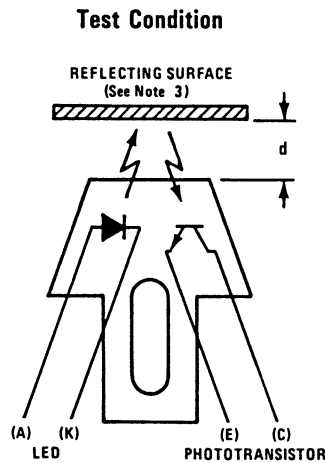
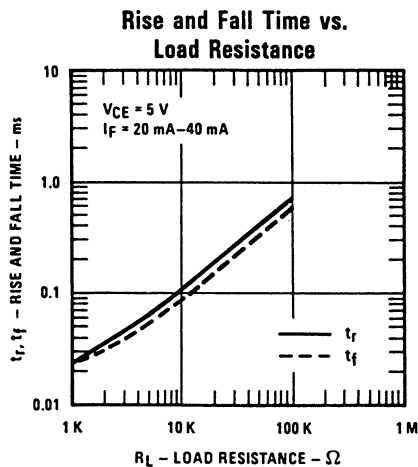
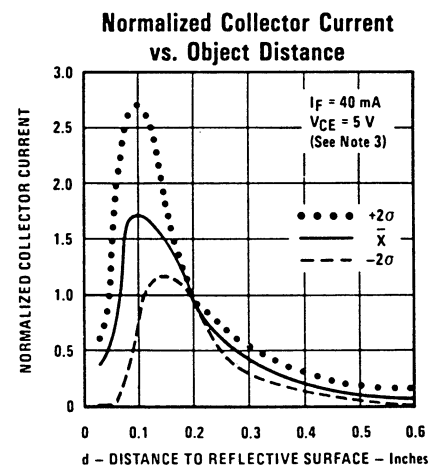
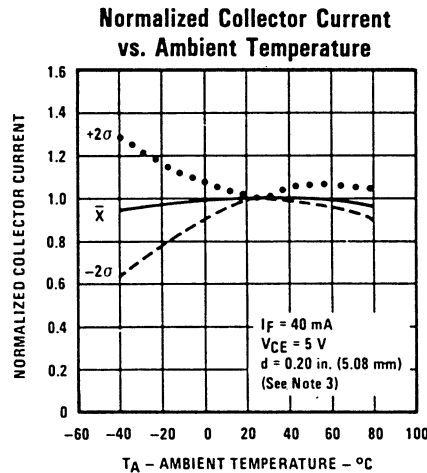
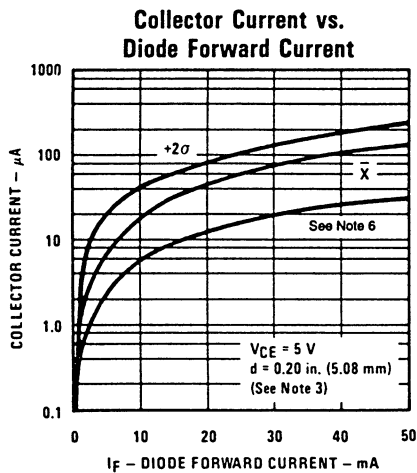

Optek reserves the right to make changes at any time in order to improve design and to supply the best product possible.
Optek Technology, Inc. 1215 W. Crosby Road Carrollton, Texas 75006 (972)323-2200 Fax (972)323-2396