

Photologic® Hermetic Sensors

Types OPL800, OPL801 Series

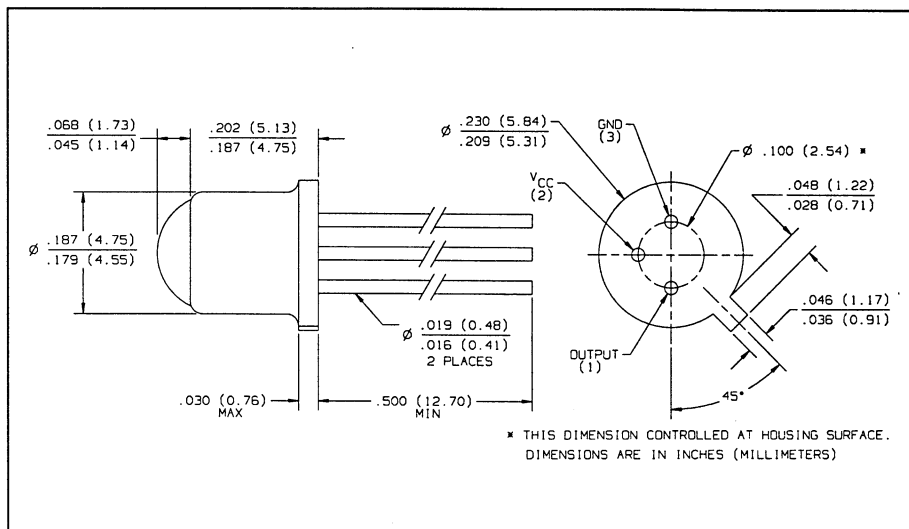
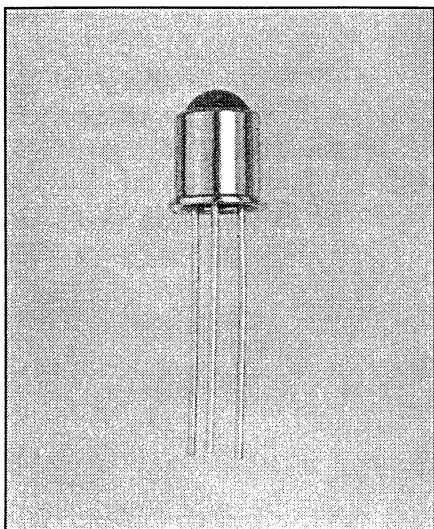

Features

- Four output options
- High noise immunity
- Direct TTL/LSTTL interface
- TO-18 hermetic package
- Mechanically and spectrally matched to OP130 and OP231 series LEDs
- Data rates to 250 kBaud
- TX-TXV process available (see Hi-Rel section)

Description

The OPL800, OPL800-OC, OPL801, and OPL801-OC each incorporate a photodiode, a linear amplifier, and a Schmitt trigger on a single silicon chip. The devices feature TTL/LSTTL compatible logic level output which can drive up to 8 TTL loads without additional circuitry. Also featured are medium speed data rates to 250 kBaud with typical rise and fall times of 25 nsec. The Schmitt trigger's hysteresis characteristics provide high immunity to noise on input and V_{CC} . The Photologic® chip is mounted on a standard TO-18 header which is hermetically sealed in a lensed metal can. These devices are mechanically and spectrally matched to OP130 and OP230 infrared emitting diodes.

Absolute Maximum Ratings ($T_A = 25^\circ\text{C}$ unless otherwise noted)

Supply Voltage, V_{CC} (not to exceed 3 seconds)	+10 V
Storage Temperature Range	-65° C to +150° C
Operating Temperature Range	-55° C to +110° C
Lead Soldering Temperature [1/16 inch (1.6 mm) from case for 5 sec. with soldering iron]	260° C ⁽¹⁾
Power Dissipation	120 mW ⁽²⁾
Duration of Output Short to V_{CC} or Ground (OPL800, OPL801)	1.00 sec.
Duration of Output Short to V_{CC} (OPL800-OC, OPL801-OC)	1.00 sec.
Voltage at Output Lead (OPL800-OC, OPL801-OC)	35 V
Irradiance	3 mW/cm ²

Notes:

- (1) RMA flux is recommended. Duration can be extended to 10 sec. max. when flow soldering. Max. 20 grams force may be applied to leads when soldering.
- (2) Derate linearly 3.4 mW/°C above 90° C.
- (3) Light measurements are made with $\lambda = 935\text{ nm}$.

Schematic

OPL800 (Totem-Pole Output) Buffer

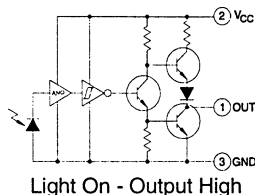

OPL801 (Totem-Pole Output) Inverter

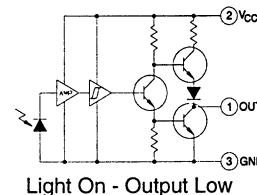

OPL800-OC (Open-Collector Output) Buffer

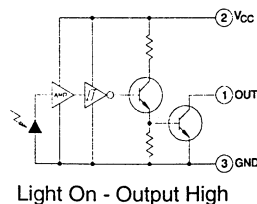

OPL801-OC (Open-Collector Output) Inverter

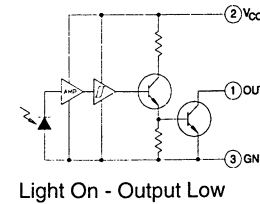

Types OPL800, OPL801 Series

Electrical Characteristics (-40° C to +100° C unless otherwise noted)

SYMBOL	PARAMETER	MIN	TYP	MAX	UNITS	TEST CONDITIONS
V _{CC}	Operating Supply Voltage	4.5		5.5	V	
	Peak-to-Peak V _{CC} Ripple Necessary to Cause False Triggering of Output		2.0		V	V _{CC} = 5 VDC f = DC to 50 MHz
E _{eT} (+)	Positive-Going Threshold Irradiance	0.05	0.18	0.60	mW/cm ²	V _{CC} = 5 V, T _A = 25° C ⁽³⁾
E _{eT} (+)/E _{eT} (-)	Hysteresis Ratio	1.5	2.0	2.5		
I _{CC}	Supply Current			15	mA	V _{CC} = 5.5 V, E _e = 0 or 1 mW/cm ²
OPL800 (Buffer, Totem-Pole)						
V _{OH}	High Level Output Voltage	2.4			V	V _{CC} = 4.5 V, I _{OH} = -800 μA, E _e = 1 mW/cm ²
V _{OL}	Low Level Output Voltage			0.40	V	V _{CC} = 4.5 V, I _{OL} = 12.8 mA, E _e = 0
I _{OS}	Short Circuit Output Current	-20		-100	mA	V _{CC} = 5.5 V, E _e = 1 mW/cm ² , Output = GND
OPL800-OC (Buffer, Open-Collector)						
I _{OH}	High Level Output Current			100	μA	V _{CC} = 4.5 V, V _{OH} = 30 V, E _e = 2 mW/cm ²
V _{OL}	Low Level Output Voltage			0.40	V	V _{CC} = 4.5 V, I _{OL} = 12.8 mA, E _e = 0
OPL801 (Inverter, Totem-Pole)						
V _{OH}	High Level Output Voltage	2.4			V	V _{CC} = 4.5 V, I _{OH} = -800 μA, E _e = 0
V _{OL}	Low Level Output Current			0.40	V	V _{CC} = 4.5 V, I _{OL} = 12.8 mA, E _e = 1 mW/cm ²
I _{OS}	Short Circuit Output Current	-20		-100	mA	V _{CC} = 5.5 V, E _e = 0, Output = GND
OPL801-OC (Inverter, Open-Collector)						
I _{OH}	High Level Output Current			100	μA	V _{CC} = 4.5 V, V _{OH} = 30 V, E _e = 0
V _{OL}	Low Level Output Voltage			0.40	V	V _{CC} = 4.5 V, I _{OL} = 12.8 mA, E _e = 1 mW/cm ²
OPL800, OPL801						
t _r , t _f	Output Rise Time, Output Fall Time		70		ns	V _{CC} = 5 V, T _A = 25° C, E _e = 0 or 1 mW/cm ²
t _{PLH} , t _{PHL}	Propagation Delay, Low-High, High-Low		5.0		μs	f = 10 kHz, D.C. = 50%, R _L = 8 TTL Loads
OPL800-OC, OPL801-OC						
t _r , t _f	Output Rise Time, Output Fall Time		70		ns	V _{CC} = 5 V, T _A = 25° C, E _e = 0 or 1 mW/cm ²
t _{PLH} , t _{PHL}	Propagation Delay, Low-High, High-Low		5.0		μs	f = 10 kHz, D.C. = 50%, R _L = 360 Ω

PHOTOLOGIC®
SENSORS

Optek reserves the right to make changes at any time in order to improve design and to supply the best product possible.
Optek Technology, Inc. 1215 W. Crosby Road Carrollton, Texas 75006 (972)323-2200 Fax (972)323-2396

Typical Performance Curves

OPL800, OPL801

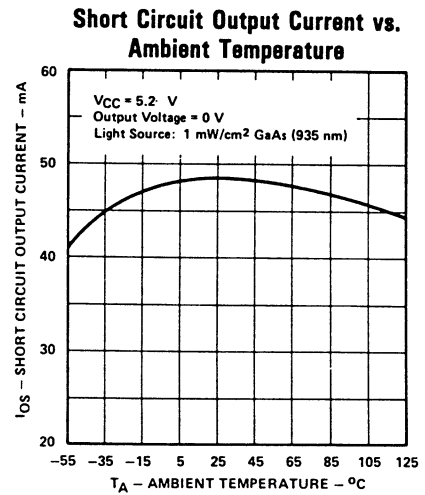
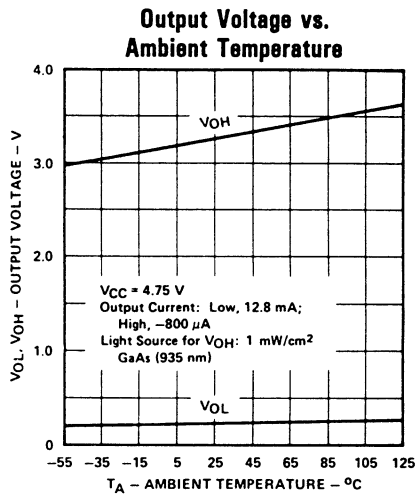

OPL800-OC, OPL801-OC

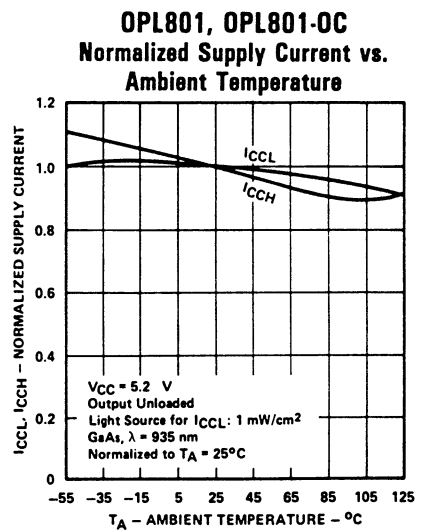
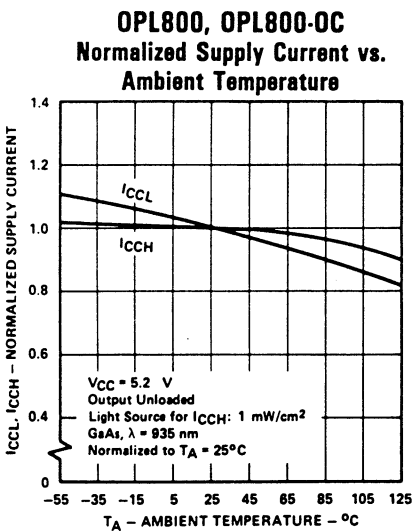
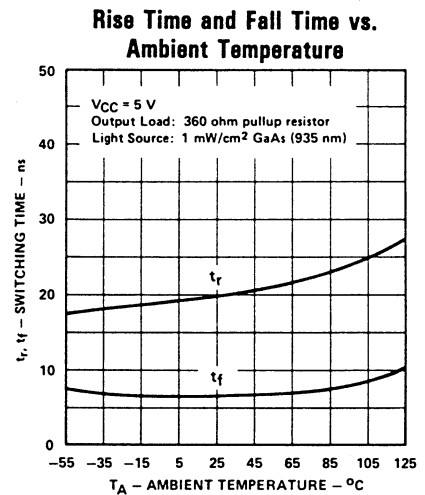
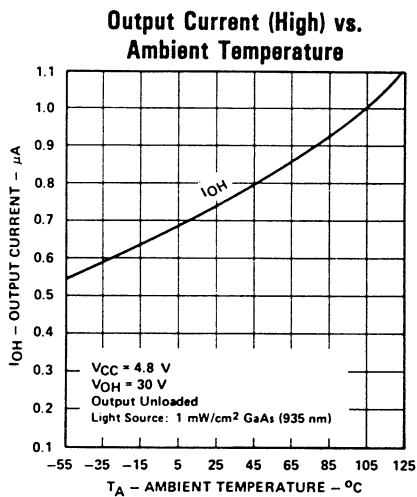

Types OPL800, OPL801 Series

Typical Performance Curves

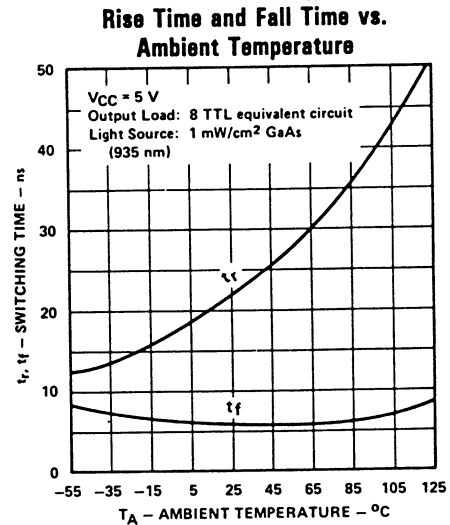
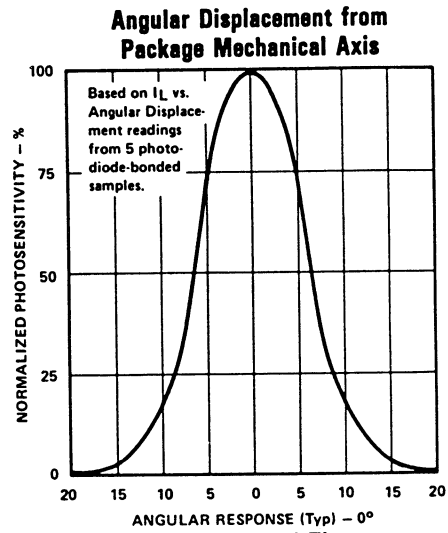
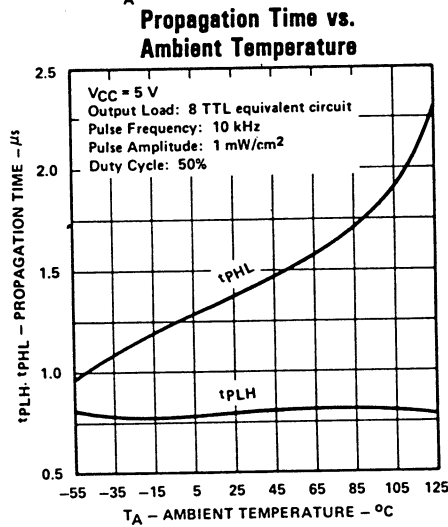
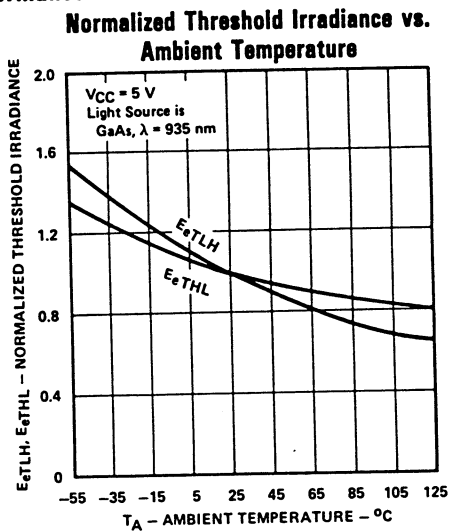

Switching Test Curve for Inverters

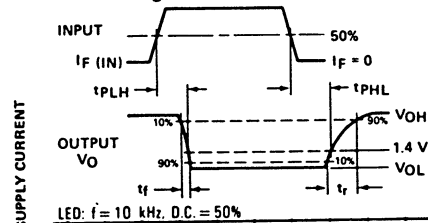

Switching Test Curve for Buffers

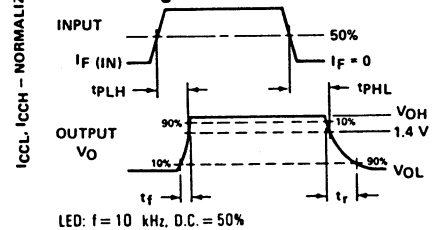

PHOTLOGIC®
SENSORS