

## IR Receiver Module for PCM Remote Control Systems

### Description

The TSOP52.. - series are miniaturized SMD-IR Receiver Modules for infrared remote control systems. PIN diode and preamplifier are assembled on lead frame, the epoxy package is designed as IR filter.

The demodulated output signal can directly be decoded by a microprocessor. TSOP52.. is the standard IR remote control SMD-Receiver series, supporting all major transmission codes.

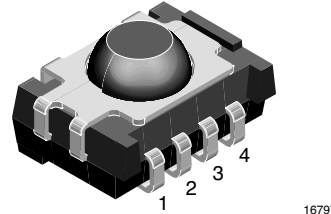

### Features

- Photo detector and preamplifier in one package
- Internal filter for PCM frequency
- Continuous data transmission possible
- TTL and CMOS compatibility
- Output active low
- Low power consumption
- High immunity against ambient light
- Suitable burst length  $\geq 10$  cycles/burst
- Taping available for topview and sideview assembly
- Lead (Pb)-free component
- Component in accordance to RoHS 2002/95/EC and WEEE 2002/96/EC



### Parts Table

Part	Carrier Frequency
TSOP5230	30 kHz
TSOP5233	33 kHz
TSOP5236	36 kHz
TSOP5237	36.7 kHz
TSOP5238	38 kHz
TSOP5240	40 kHz
TSOP5256	56 kHz

### Absolute Maximum Ratings

Absolute Maximum Ratings

$T_{amb} = 25^\circ\text{C}$ , unless otherwise specified

Parameter	Test condition	Symbol	Value	Unit
Supply Voltage	Pin 4	$V_S$	-0.3...6.0	V
Supply Current	Pin 4	$I_S$	5	mA
Output Voltage	Pin 3	$V_O$	-0.3...6.0	V
Output Current	Pin 3	$I_O$	15	mA
Junction Temperature		$T_j$	100	$^\circ\text{C}$
Storage Temperature Range		$T_{stg}$	-40...+85	$^\circ\text{C}$
Operating Temperature Range		$T_{amb}$	-25...+85	$^\circ\text{C}$
Power Consumption	$T_{amb} \leq 85^\circ\text{C}$	$P_{tot}$	50	mW

### Electrical and Optical Characteristics

T<sub>amb</sub> = 25 °C, unless otherwise specified

Parameter	Test condition	Symbol	Min	Typ.	Max	Unit
Supply Current	V <sub>S</sub> = 5 V, E <sub>v</sub> = 0	I <sub>SD</sub>	0.8	1.1	1.5	mA
	V <sub>S</sub> = 5 V, E <sub>v</sub> = 40 klx, sunlight	I <sub>SH</sub>		1.4		mA
Supply Voltage		V <sub>S</sub>	4.5		5.5	V
Transmission Distance	E <sub>v</sub> = 0, test signal see fig.7, IR diode TSAL6200, I <sub>F</sub> = 400 mA	d		30		m

### Optical Characteristics

T<sub>amb</sub> = 25 °C, unless otherwise specified

Parameter	Test condition	Symbol	Min	Typ.	Max	Unit
Output Voltage Low (Pin 3)	I <sub>OSL</sub> = 0.5 mA, E <sub>e</sub> = 0.7 mW/m <sup>2</sup>	V <sub>OSL</sub>			250	mV
Minimum Irradiance (30 - 40 kHz)	Pulse width tolerance: t <sub>pi</sub> - 5/f <sub>o</sub> < t <sub>po</sub> < t <sub>pi</sub> + 6/f <sub>o</sub> , test signal see fig.7	E <sub>e min</sub>		0.35	0.5	mW/m <sup>2</sup>
Minimum Irradiance (56 kHz)	Pulse width tolerance: t <sub>pi</sub> - 5/f <sub>o</sub> < t <sub>po</sub> < t <sub>pi</sub> + 6/f <sub>o</sub> , test signal see fig.7	E <sub>e min</sub>		0.4	0.6	mW/m <sup>2</sup>
Maximum Irradiance	t <sub>pi</sub> - 5/f <sub>o</sub> < t <sub>po</sub> < t <sub>pi</sub> + 6/f <sub>o</sub>	E <sub>e max</sub>	30			W/m <sup>2</sup>
Directivity	Angle of half transmission distance	φ <sub>1/2</sub>		±50		deg

### Typical Characteristics (T<sub>amb</sub> = 25 °C unless otherwise specified)

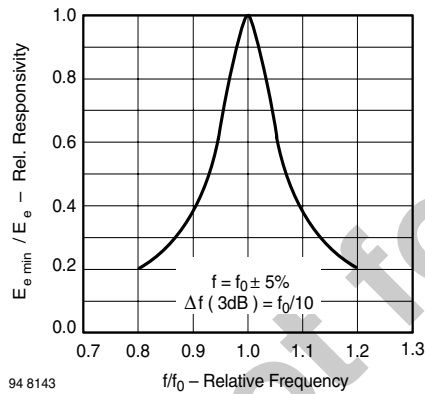

Figure 1. Frequency Dependence of Responsivity

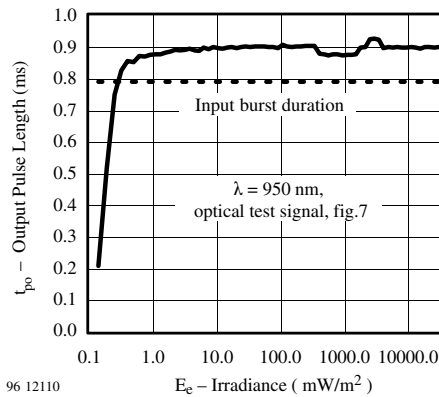

Figure 2. Sensitivity in Dark Ambient

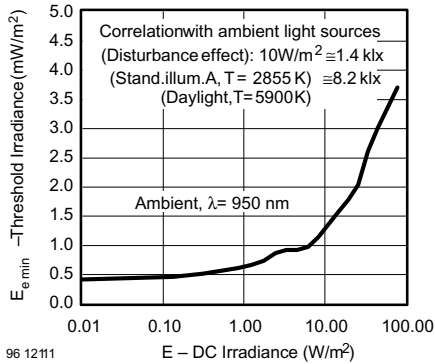

Figure 3. Sensitivity in Bright Ambient

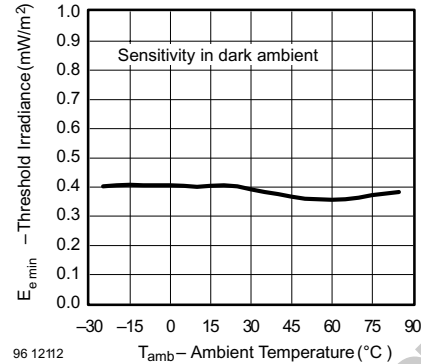

Figure 6. Sensitivity vs. Ambient Temperature

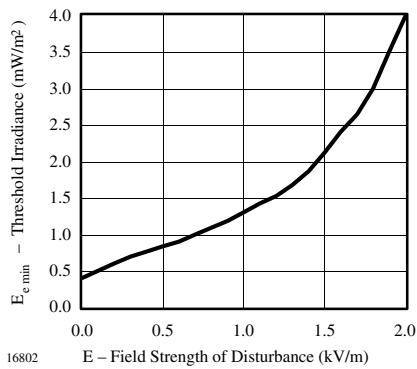

Figure 4. Threshold Irradiance vs. Field Strength of Disturbance

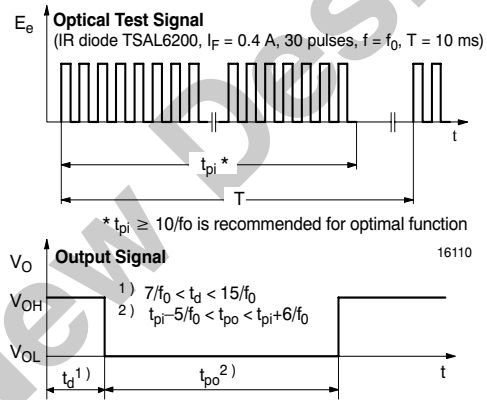

Figure 7. Output Function

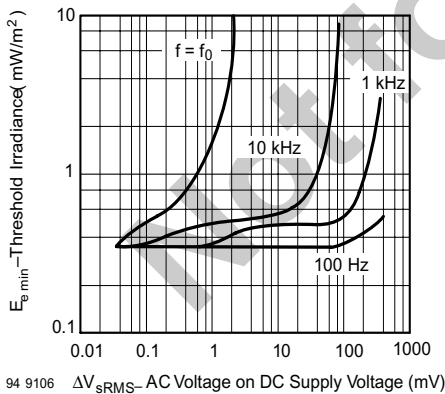

Figure 5. Sensitivity vs. Supply Voltage Disturbances

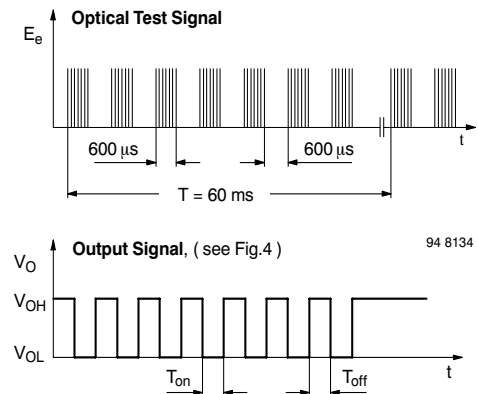

Figure 8. Output Function

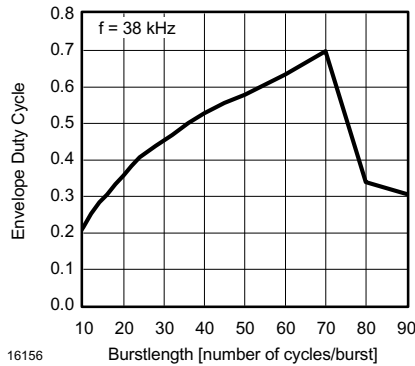

Figure 9. Max. Envelope Duty Cycle vs. Burstlength

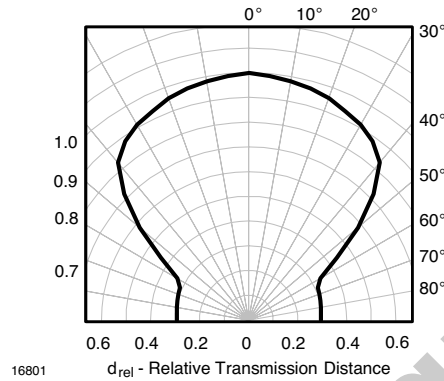

Figure 12. Directivity

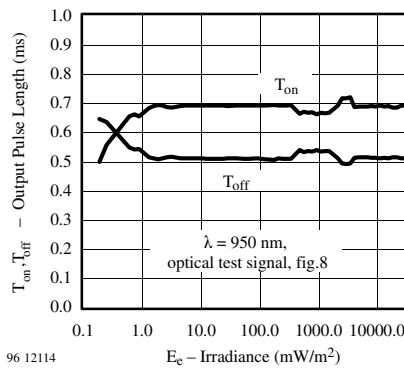

Figure 10. Output Pulse Diagram

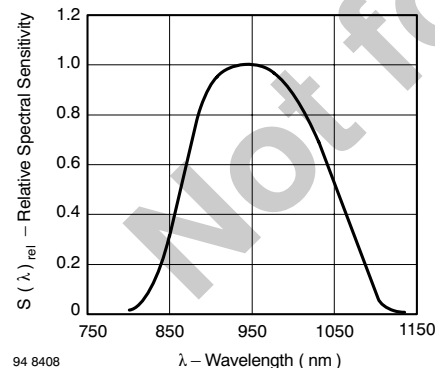

Figure 11. Relative Spectral Sensitivity vs. Wavelength

### Suitable Data Format

The circuit of the TSOP52.. is designed in that way that unexpected output pulses due to noise or disturbance signals are avoided. A bandpass filter, an integrator stage and an automatic gain control are used to suppress such disturbances.

The distinguishing mark between data signal and disturbance signal are carrier frequency, burst length and duty cycle.

The data signal should fulfill the following condition:

- Carrier frequency should be close to center frequency of the bandpass (e.g. 38kHz).
- Burst length should be 10 cycles/burst or longer.
- After each burst which is between 10 cycles and 70 cycles a gap time of at least 14 cycles is necessary.
- For each burst which is longer than 1.8ms a corresponding gap time is necessary at some time in the data stream. This gap time should be at least 4 times longer than the burst.
- Up to 800 short bursts per second can be received continuously.

Some examples for suitable data format are: NEC Code, Toshiba Micom Format, Sharp Code, RC5 Code, RC6 Code, R-2000 Code.

When a disturbance signal is applied to the TSOP52.. it can still receive the data signal. However the sensitivity is reduced to that level that no unexpected pulses will occur.

Some examples for such disturbance signals which are suppressed by the TSOP52.. are:

- DC light (e.g. from tungsten bulb or sunlight)
- Continuous signal at 38kHz or at any other frequency

- Signals from fluorescent lamps with electronic ballast with high or low modulation ( see Figure A or Figure B ).

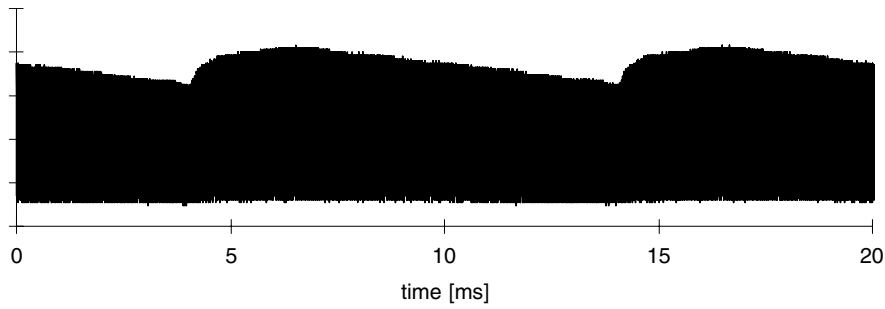

16739

Figure 13. IR Signal from Fluorescent Lamp with low Modulation

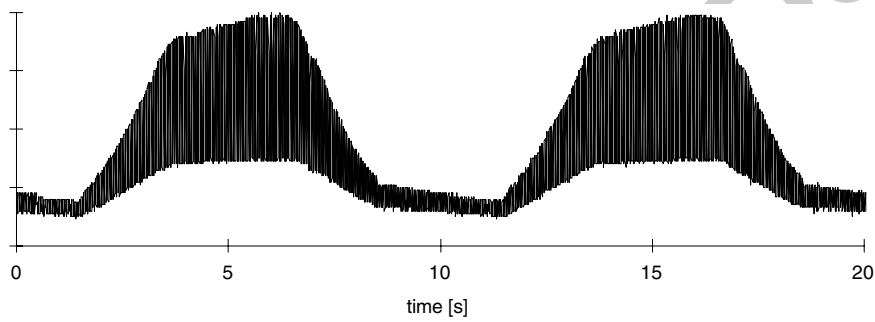

16740

Figure 14. IR Signal from Fluorescent Lamp with high Modulation

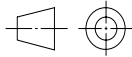

technical drawings  
according to DIN  
specifications

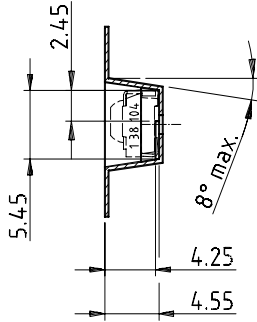

Drawing-No.: 9.700-5259.01-4  
Issue: 1; 05.09.01

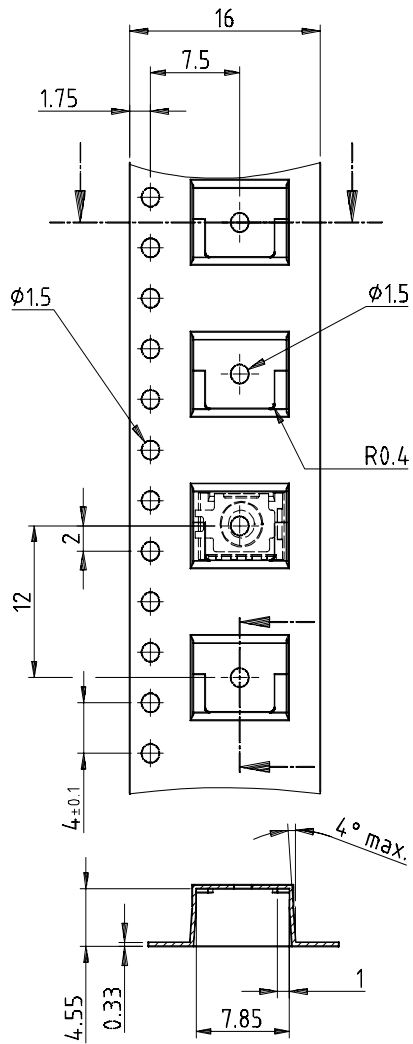

16584

technical drawings  
according to DIN  
specifications

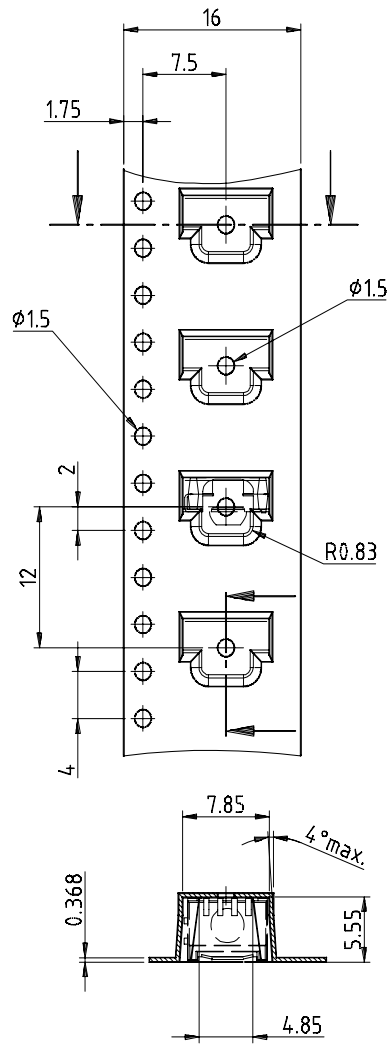
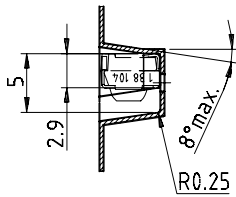

Drawing-No.: 9.700-5260.01-4  
Issue: 2; 25.09.01

16585

## Package Dimensions in mm

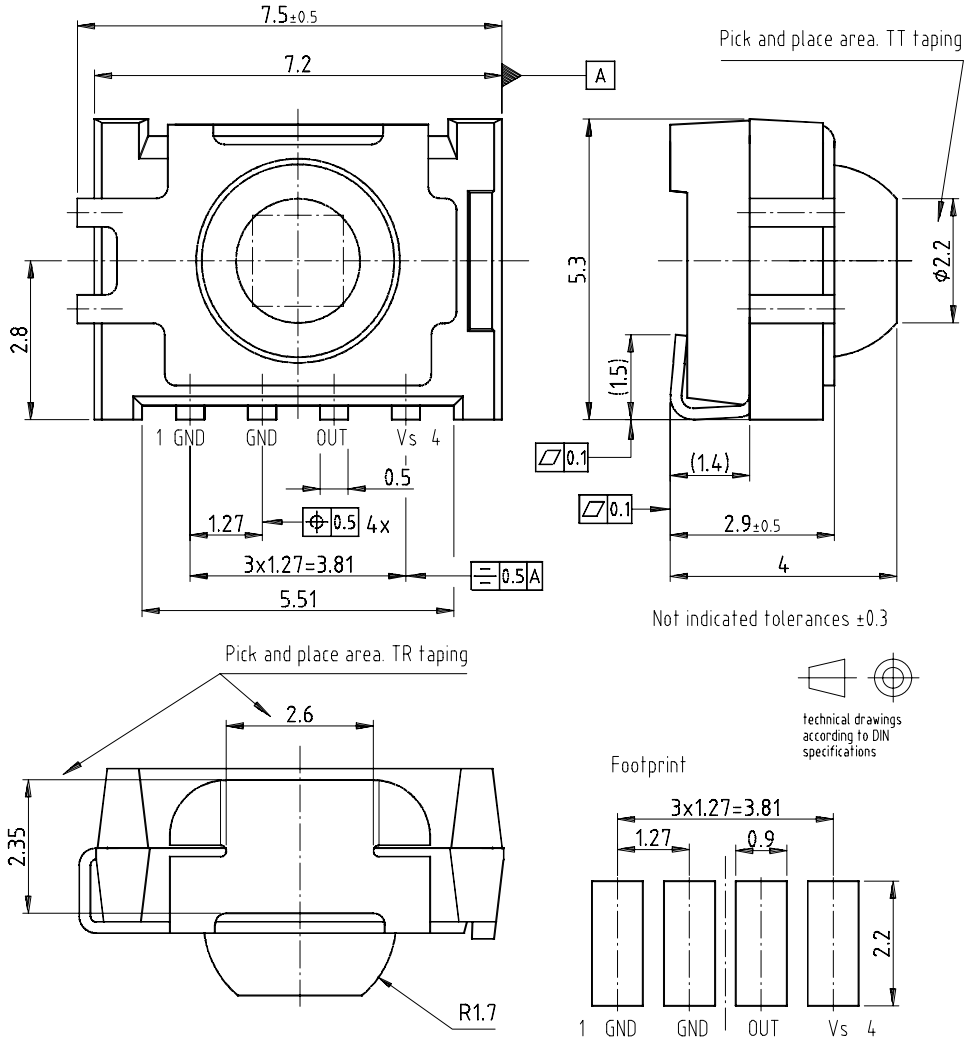

Drawing-No.: 6.544-5341.01-4  
Issue: 5; 28.10.02

16776



## Ozone Depleting Substances Policy Statement

It is the policy of Vishay Semiconductor GmbH to

1. Meet all present and future national and international statutory requirements.
2. Regularly and continuously improve the performance of our products, processes, distribution and operating systems with respect to their impact on the health and safety of our employees and the public, as well as their impact on the environment.

It is particular concern to control or eliminate releases of those substances into the atmosphere which are known as ozone depleting substances (ODSs).

The Montreal Protocol (1987) and its London Amendments (1990) intend to severely restrict the use of ODSs and forbid their use within the next ten years. Various national and international initiatives are pressing for an earlier ban on these substances.

Vishay Semiconductor GmbH has been able to use its policy of continuous improvements to eliminate the use of ODSs listed in the following documents.

1. Annex A, B and list of transitional substances of the Montreal Protocol and the London Amendments respectively
2. Class I and II ozone depleting substances in the Clean Air Act Amendments of 1990 by the Environmental Protection Agency (EPA) in the USA
3. Council Decision 88/540/EEC and 91/690/EEC Annex A, B and C (transitional substances) respectively.

Vishay Semiconductor GmbH can certify that our semiconductors are not manufactured with ozone depleting substances and do not contain such substances.

We reserve the right to make changes to improve technical design and may do so without further notice.

Parameters can vary in different applications. All operating parameters must be validated for each customer application by the customer. Should the buyer use Vishay Semiconductors products for any unintended or unauthorized application, the buyer shall indemnify Vishay Semiconductors against all claims, costs, damages, and expenses, arising out of, directly or indirectly, any claim of personal damage, injury or death associated with such unintended or unauthorized use.

Vishay Semiconductor GmbH, P.O.B. 3535, D-74025 Heilbronn, Germany



## Notice

Specifications of the products displayed herein are subject to change without notice. Vishay Intertechnology, Inc., or anyone on its behalf, assumes no responsibility or liability for any errors or inaccuracies.

Information contained herein is intended to provide a product description only. No license, express or implied, by estoppel or otherwise, to any intellectual property rights is granted by this document. Except as provided in Vishay's terms and conditions of sale for such products, Vishay assumes no liability whatsoever, and disclaims any express or implied warranty, relating to sale and/or use of Vishay products including liability or warranties relating to fitness for a particular purpose, merchantability, or infringement of any patent, copyright, or other intellectual property right.

The products shown herein are not designed for use in medical, life-saving, or life-sustaining applications. Customers using or selling these products for use in such applications do so at their own risk and agree to fully indemnify Vishay for any damages resulting from such improper use or sale.