

IR Receiver Modules for Remote Control Systems

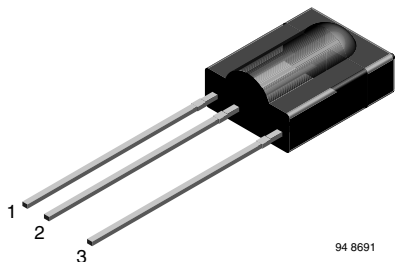

94 8691

MECHANICAL DATA

Pinning:

1 = GND, 2 = V_S , 3 = OUT

FEATURES

- Very low supply current
- Photo detector and preamplifier in one package
- Internal filter for PCM frequency
- Improved shielding against EMI
- Supply voltage: 2.5 V to 5.5 V
- Improved immunity against ambient light
- Compliant to RoHS Directive 2002/95/EC and in accordance to WEEE 2002/96/EC
- Insensitive to supply voltage ripple and noise



RoHS
COMPLIANT

GREEN
(5-2008)**

DESCRIPTION

The TSOP311.., TSOP313.. and TSOP315.. series are miniaturized receivers for infrared remote control systems. A PIN diode and a preamplifier are assembled on a lead frame, the epoxy package acts as an IR filter.

The demodulated output signal can be directly decoded by a microprocessor. The TSOP311.. is compatible with all common IR remote control data formats. The TSOP313.. is optimized to better suppress spurious pulses from energy saving fluorescent lamps. The TSOP315.. has an excellent noise suppression. It is immune to dimmed LCD backlighting and any fluorescent lamps. AGC3 and AGC5 may also suppress some data signals in case of continuous transmission.

This component has not been qualified according to automotive specifications.

PARTS TABLE

CARRIER FREQUENCY	SHORT BURSTS AND HIGH DATA RATES (AGC1)	NOISY ENVIRONMENTS AND SHORT BURSTS (AGC3)	VERY NOISY ENVIRONMENTS AND SHORT BURSTS (AGC5)
30 kHz	TSOP31130	TSOP31330	TSOP31530
33 kHz	TSOP31133	TSOP31333	TSOP31533
36 kHz	TSOP31136	TSOP31336	TSOP31536
38 kHz	TSOP31138	TSOP31338	TSOP31538
40 kHz	TSOP31140	TSOP31340	TSOP31540
56 kHz	TSOP31156	TSOP31356	TSOP31556

BLOCK DIAGRAM

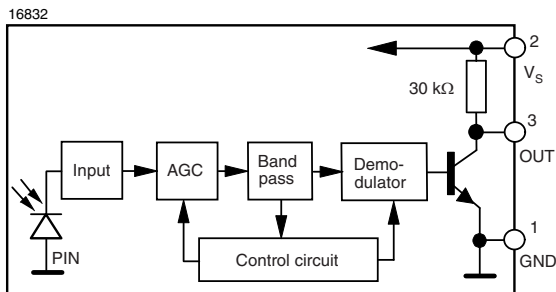

APPLICATION CIRCUIT

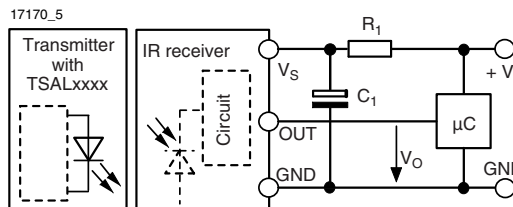

R_1 and C_1 are recommended for protection against EOS. Components should be in the range of $33 \Omega < R_1 < 1 \text{ k}\Omega$, $C_1 > 0.1 \mu\text{F}$.

** Please see document "Vishay Material Category Policy": www.vishay.com/doc/99902

ABSOLUTE MAXIMUM RATINGS				
PARAMETER	TEST CONDITION	SYMBOL	VALUE	UNIT
Supply voltage (pin 2)		V_S	- 0.3 to + 6	V
Supply current (pin 2)		I_S	3	mA
Output voltage (pin 3)		V_O	- 0.3 to ($V_S + 0.3$)	V
Output current (pin 3)		I_O	5	mA
Junction temperature		T_J	100	°C
Storage temperature range		T_{stg}	- 25 to + 85	°C
Operating temperature range		T_{amb}	- 25 to + 85	°C
Power consumption	$T_{amb} \leq 85\text{ °C}$	P_{tot}	10	mW
Soldering temperature	$t \leq 10\text{ s}$, 1 mm from case	T_{sd}	260	°C

Note

- Stresses beyond those listed under “Absolute Maximum Ratings” may cause permanent damage to the device. This is a stress rating only and functional operation of the device at these or any other conditions beyond those indicated in the operational sections of this specification is not implied. Exposure to absolute maximum rating conditions for extended periods may affect the device reliability.

ELECTRICAL AND OPTICAL CHARACTERISTICS ($T_{amb} = 25\text{ °C}$, unless otherwise specified)						
PARAMETER	TEST CONDITION	SYMBOL	MIN.	TYP.	MAX.	UNIT
Supply current (pin 2)	$E_v = 0$, $V_S = 3.3\text{ V}$	I_{SD}	0.27	0.35	0.45	mA
	$E_v = 40\text{ klx}$, sunlight	I_{SH}		0.45		mA
Supply voltage		V_S	2.5		5.5	V
Transmission distance	$E_v = 0$, test signal see fig. 1, IR diode TSAL6200, $I_F = 250\text{ mA}$	d		45		m
Output voltage low (pin 3)	$I_{OSL} = 0.5\text{ mA}$, $E_e = 0.7\text{ mW/m}^2$, test signal see fig. 1	V_{OSL}			100	mV
Minimum irradiance	Pulse width tolerance: $t_{pi} - 5/f_0 < t_{po} < t_{pi} + 6/f_0$, test signal see fig. 1	$E_e\text{ min.}$		0.15	0.35	mW/m^2
Maximum irradiance	$t_{pi} - 5/f_0 < t_{po} < t_{pi} + 6/f_0$, test signal see fig. 1	$E_e\text{ max.}$	30			W/m^2
Directivity	Angle of half transmission distance	$\Phi_{1/2}$		± 45		deg

TYPICAL CHARACTERISTICS ($T_{amb} = 25\text{ °C}$, unless otherwise specified)

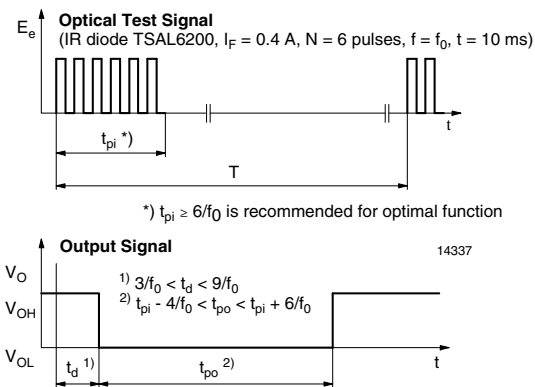

Fig. 1 - Output Active Low

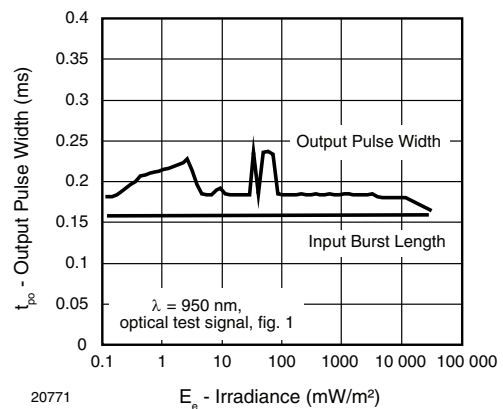

Fig. 2 - Pulse Length and Sensitivity in Dark Ambient

TSOP311.., TSOP313.., TSOP315..



Vishay Semiconductors IR Receiver Modules for Remote Control Systems

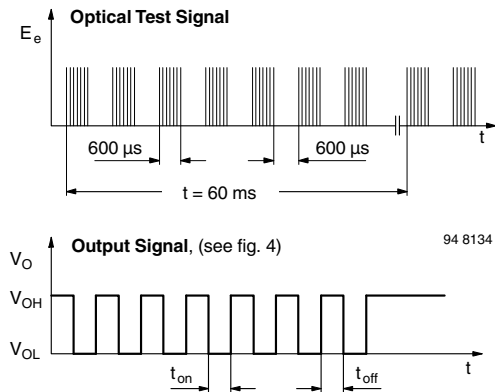

Fig. 3 - Output Function

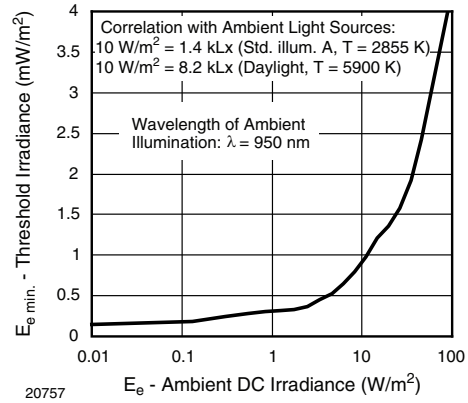

Fig. 6 - Sensitivity in Bright Ambient

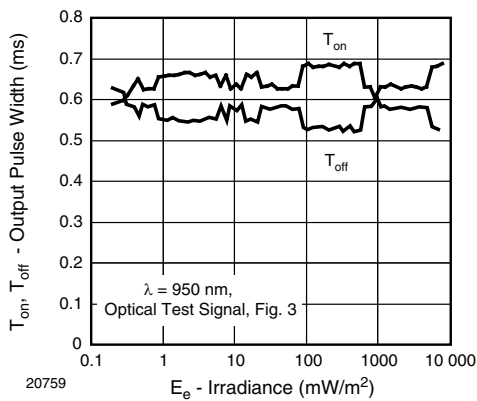

Fig. 4 - Output Pulse Diagram

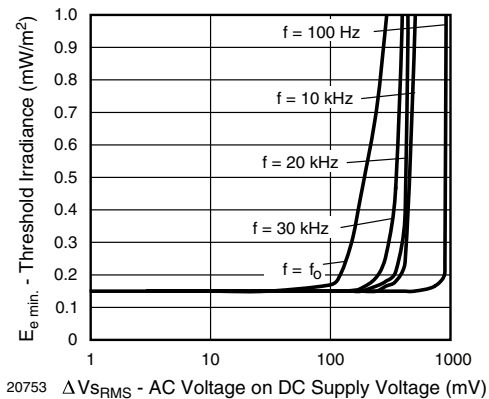

Fig. 7 - Sensitivity vs. Supply Voltage Disturbances

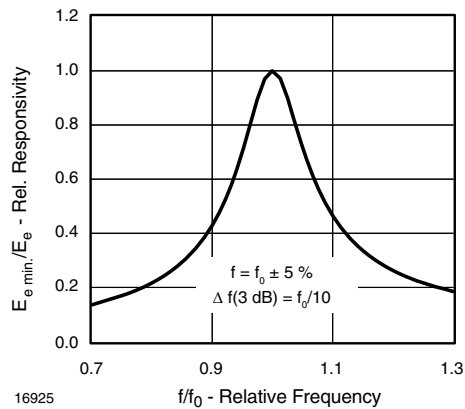

Fig. 5 - Frequency Dependence of Responsivity

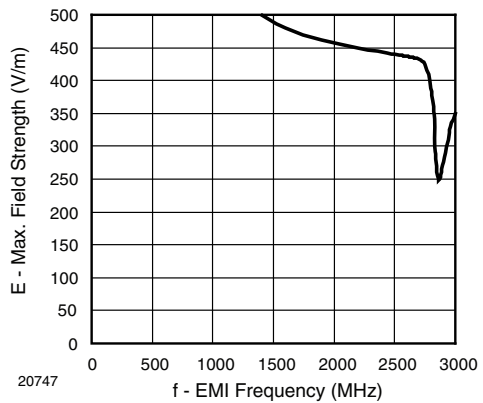

Fig. 8 - Sensitivity vs. Electric Field Disturbances

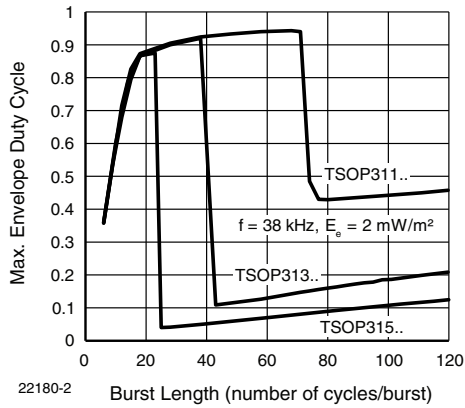

Fig. 9 - Max. Envelope Duty Cycle vs. Burst Length

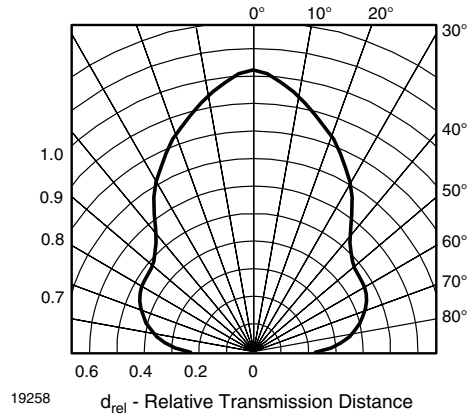

Fig. 12 - Horizontal Directivity

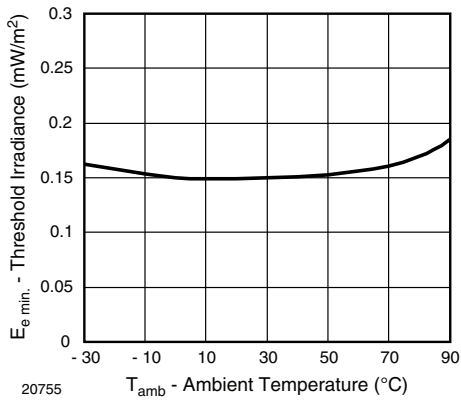

Fig. 10 - Sensitivity vs. Ambient Temperature

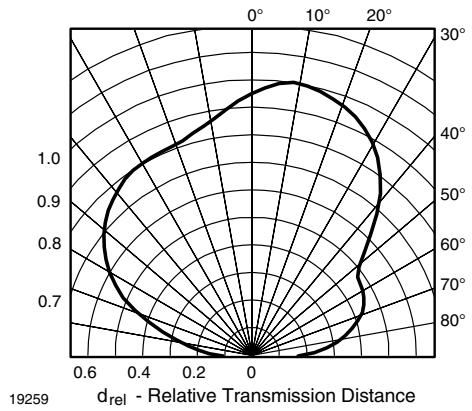

Fig. 13 - Vertical Directivity

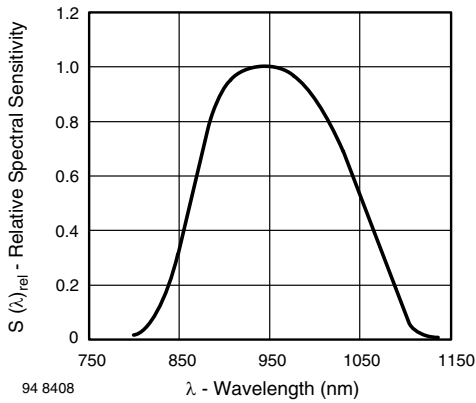

Fig. 11 - Relative Spectral Sensitivity vs. Wavelength

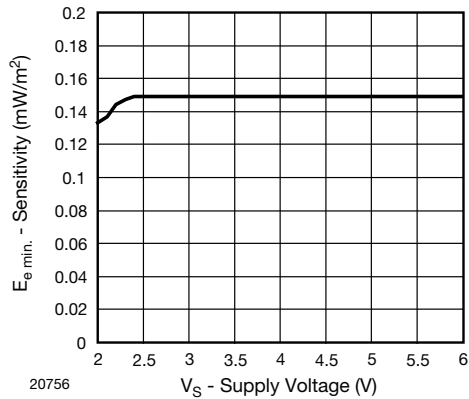

Fig. 14 - Sensitivity vs. Supply Voltage

SUITABLE DATA FORMAT

The TSOP311.., TSOP313.. and TSOP315.. series are designed to suppress spurious output pulses due to noise or disturbance signals. Data and disturbance signals can be distinguished by the devices according to carrier frequency, burst length and envelope duty cycle. The data signal should be close to the band-pass center frequency (e.g. 38 kHz) and fulfill the conditions in the table below.

When a data signal is applied to the TSOP311.., TSOP313.. and TSOP315.. in the presence of a disturbance signal, the sensitivity of the receiver is reduced to insure that no spurious pulses are present at the output. Some examples of disturbance signals which are suppressed are:

- DC light (e.g. from tungsten bulb or sunlight)
- Continuous signals at any frequency
- Modulated noise from fluorescent lamps with electronic ballasts

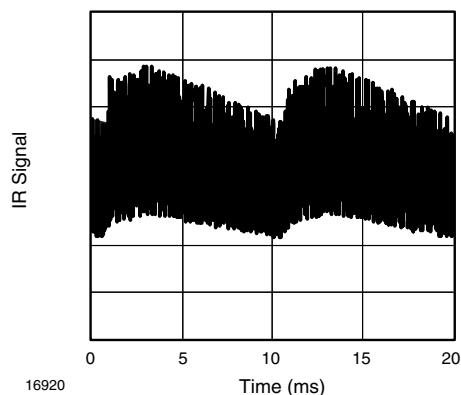

Fig. 15 - IR Signal from Fluorescent Lamp with Low Modulation

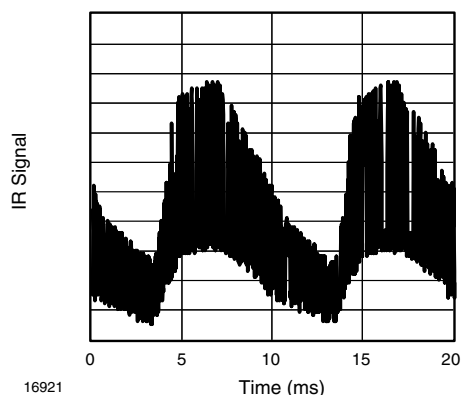

Fig. 16 - IR Signal from Fluorescent Lamp with High Modulation

	TSOP311..	TSOP313..	TSOP315..
Minimum burst length	6 cycles/burst	6 cycles/burst	6 cycles/burst
After each burst of length A gap time is required of	6 to 70 cycles ≥ 10 cycles	6 to 35 cycles ≥ 10 cycles	6 to 24 cycles ≥ 10 cycles
For bursts greater than a minimum gap time in the data stream is needed of	70 cycles > 1.2 x burst length	35 cycles > 6 x burst length	24 cycles > 25 ms
Maximum number of continuous short bursts/second	2000	2000	2000
Recommended for NEC code	yes	yes	yes
Recommended for RC5/RC6 code	yes	yes	yes
Recommended for Sony code	yes	no	no
Recommended for RCMM code	yes	yes	yes
Recommended for r-step code	yes	yes	yes
Recommended for XMP code	yes	yes	yes
Suppression of interference from fluorescent lamps	Common disturbance signals are suppressed (example: signal pattern of fig. 15)	Even critical disturbance signals are suppressed (examples: signal pattern of fig. 15 and fig. 16)	Even critical disturbance signals are suppressed (examples: signal pattern of fig. 15 and fig. 16)

Note

- For data formats with short bursts please see the datasheet for TSOP312.., TSOP314..



TSOP311.., TSOP313.., TSOP315..

IR Receiver Modules for Remote Control Systems Vishay Semiconductors

PACKAGE DIMENSIONS in millimeters

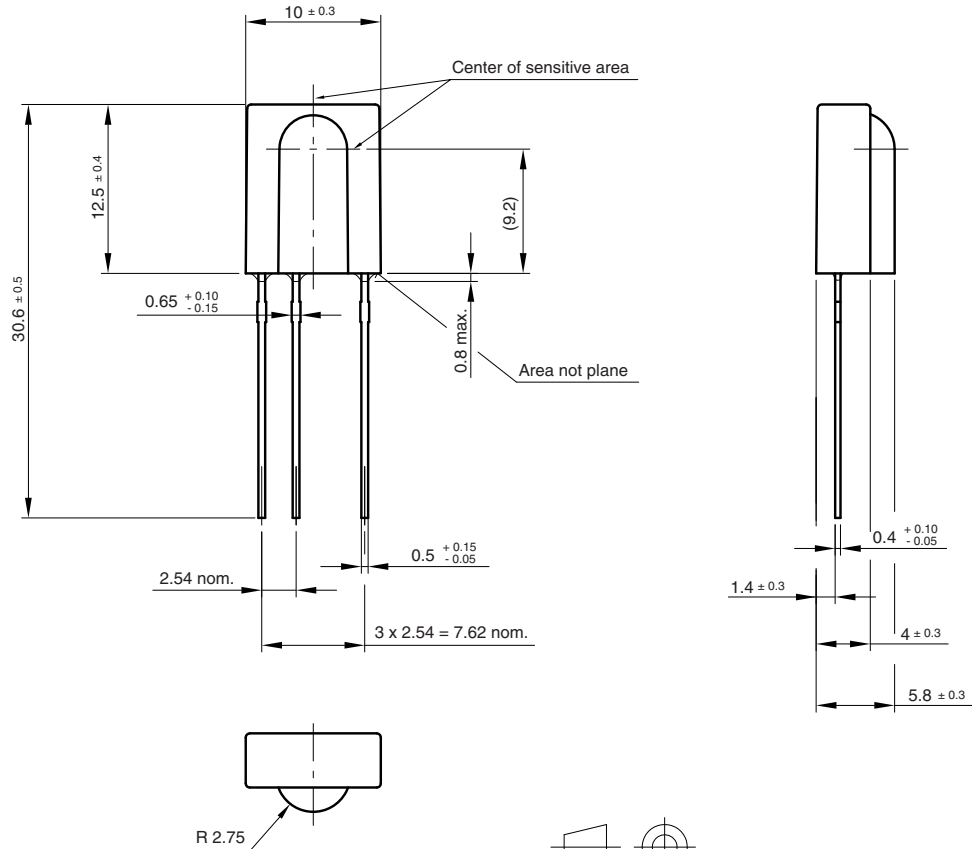

Drawing-No.: 6.550-5095.01-4
Issue: 20; 15.03.10
96 12116



Disclaimer

All product specifications and data are subject to change without notice.

Vishay Intertechnology, Inc., its affiliates, agents, and employees, and all persons acting on its or their behalf (collectively, "Vishay"), disclaim any and all liability for any errors, inaccuracies or incompleteness contained herein or in any other disclosure relating to any product.

Vishay disclaims any and all liability arising out of the use or application of any product described herein or of any information provided herein to the maximum extent permitted by law. The product specifications do not expand or otherwise modify Vishay's terms and conditions of purchase, including but not limited to the warranty expressed therein, which apply to these products.

No license, express or implied, by estoppel or otherwise, to any intellectual property rights is granted by this document or by any conduct of Vishay.

The products shown herein are not designed for use in medical, life-saving, or life-sustaining applications unless otherwise expressly indicated. Customers using or selling Vishay products not expressly indicated for use in such applications do so entirely at their own risk and agree to fully indemnify Vishay for any damages arising or resulting from such use or sale. Please contact authorized Vishay personnel to obtain written terms and conditions regarding products designed for such applications.

Product names and markings noted herein may be trademarks of their respective owners.