

## Features

### Regulated Converters

- UL Certified Constant Current LED Driver
- Wide Input and Output Voltage Range
- Digital PWM and Analogue Voltage Dimming
- Short Circuit and Overtemperature Protected
- Pin, Wire or Open Frame SMD Versions
- IP67 rated for /W Version
- 96% Efficiency
- 3 year Warranty

### Description

The RCD series is a step-down constant current source designed for driving high power white LEDs. Standard output currents available are 300mA, 350mA, 500mA, 600mA, 700mA, 1000mA and 1200mA to make this driver compatible with a wide range of LEDs applications. Despite its compact size, the RCD series is fully featured with very high efficiency, wide input voltage range, high ambient operating temperature and two means of dimming: PWM/digital control and analogue voltage dimming. Both dimming controls are independent and can be combined. The driver is also designed to be as reliable as the LEDs it is driving, even at the full operating temperature. Options include an IP67-rated wired version (/W), an open frame version with SMD pins (/SMD/OF) and a version with built-in reference output voltage (/Vref) to power sensors or for easy analogue dimming.

### Selection Guide

Part Number	Input Range (VDC)	Output Current (mA)	Output Voltage (Vmin-Vmax)	Dimming Control	Options	Mounting Style
RCD-24-0.30 <sup>(a)(b)</sup>	4.5-36V	0-300	2-35	Digital + Analogue	Vref	Pins, SMD or Wired
RCD-24-0.35 <sup>(a)(b)</sup>	4.5-36V	0-350	2-35	Digital + Analogue	Vref	Pins, SMD or Wired
RCD-24-0.50 <sup>(a)(b)</sup>	4.5-36V	0-500	2-35	Digital + Analogue	Vref	Pins, SMD or Wired
RCD-24-0.60 <sup>(a)(b)</sup>	4.5-36V	0-600	2-35	Digital + Analogue	Vref	Pins, SMD or Wired
RCD-24-0.70 <sup>(a)(b)</sup>	4.5-36V	0-700	2-35	Digital + Analogue	Vref	Pins, SMD or Wired
RCD-24-1.00 <sup>(b)</sup>	6-36V	0-1000	3-33	Digital + Analogue		Pins or Wired
RCD-24-1.20 <sup>(b)</sup>	6-36V	0-1200	3-33	Digital + Analogue		Pins or Wired

<sup>(a)(b)</sup> Standard is no suffix with PCB Pins.

<sup>(a)</sup> Add suffix /Vref for pinned or SMD versions with Vref output and analogue dimming

<sup>(a)</sup> Add suffix /SMD/OF for open frame version with SMD solderpins (/SMD/OF-R for Tape and Reel Packaging)

<sup>(b)</sup> Add suffix /W for wired version without dimming control (four wires)

<sup>(b)</sup> Add suffix /W/X1 for wired version with analogue dimming control (five wires)

<sup>(b)</sup> Add suffix /W/X2 for wired version with PWM dimming control (five wires)

<sup>(b)</sup> Add suffix /W/X3 for wired version with both analogue and PWM dimming controls (six wires)

<sup>(a)</sup> Add suffix /W/Vref for wired version with Vref output and analogue dimming (six wires)

### Specifications

( typical at 25°C, nominal input voltage, rated output current unless otherwise specified )

Input Voltage (absolute maximum)	40VDC max		
Recommended Input Voltage	300mA-700mA	5V min. / 24V typ. / 36VDC max	
	1000mA-1200mA	6V min. / 24V typ. / 36VDC max	
Input Filter	Capacitor		
Output Current Accuracy (Vin = 24DC)	300mA-700mA	±1% typ, ±3% max.	
	1000mA-1200mA	±2% typ, ±5% max.	
Internal Power Dissipation	Worst case load of 5 LEDs	800mW max	
Output Current Stability	Vin=36V, Vout =1-9 LEDs	±1% max	
Output Ripple and Noise (20MHz BW) Vin=36V, Vout =1-9 LEDs	300mA-700mA	150mVp-p max	
	1000mA-1200mA	300mVp-p max	
Temperature Coefficient	-40°C~+85°C ambient		±0.015%/°C max
Maximum Capacitive Load	100µF		
Operating Frequency	300mA-700mA	210kHz min/ 250kHz typ/ 280kHz max	
	1000mA-1200mA	350kHz min/ 450kHz typ/ 550kHz max	
Efficiency at Full Load	96% max.		
Short Circuit Protection	Regulated at rated output current		

continued on next page

## LIGHTLINE

### DC/DC-Converter

with 3 year Warranty

# RECOM

## Constant Current LED Driver



E24736

**EN-60950-1 Certified**  
**UL-60950-1 Certified**  
**(Vref Version Pending)**

# RCD-24

## Derating Graph

(Ambient Temperature)

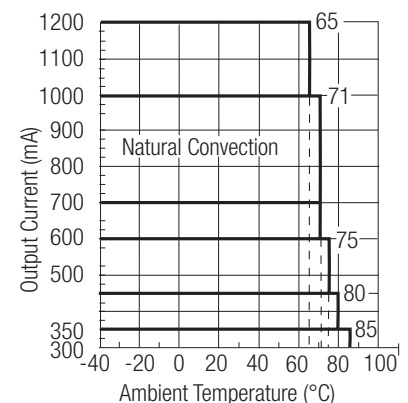

Refer to Application Notes

**Specifications -Continued**

Operating Temperature Range (free air convection)	300mA-350mA	-40°C to +85°C
	500mA	-40°C to +80°C
	600mA	-40°C to +75°C
	700mA-1000mA	-40°C to +71°C
	1200mA	-40°C to +65°C

Storage Temperature Range	-55°C to +125°C	
---------------------------	-----------------	--

Overtemperature Shutdown (Auto-restart after cool down)	Internal IC Temperature	150°C typ.
	Temperature Hysteresis	20°C typ.
Maximum Case Temperature	100°C	

Thermal Impedance	Natural Convection	55°C/Watt
-------------------	--------------------	-----------

Case Material (Pinned or Wired Versions)	Non Conductive Black Plastic	
--	------------------------------	--

Potting Material (Pinned or Wired Versions)	Epoxy (UL94-V0)	
---	-----------------	--

Dimensions	Pinned/Wired	22.1 x 12.6 x 8.5mm
	SMD	21.0 x 11.4 x 10mm

Weight	Pinned/Wired	4.5g/6.8g
	SMD	1.9g

Soldering Profile	Pinned	265°C/10 sec. max
	SMD	245°C/30 sec. max

Packing Quantities (Refer to App Notes for Tube sizes)	Pinned Versions	39pcs per Tube
	SMD Versions	21pcs per Tube
	SMD Tape and Reel	500pcs per Reel
	Wired Versions	5pcs per Bag

**PWM Dimming and ON/OFF Control** (Leave open if not used - do not tie to +Vin)

Remote ON/OFF	DC/DC ON	300mA-700mA	Open or $0V < V_r < 0.6V$
Threshold Voltages	DC/DC ON	1000mA-1200mA	Open or $0V < V_r < 0.8V$
		300mA-700mA	$0.6 < V_r < 2.9V$
	DC/DC OFF (Standby)	1000mA-1200mA	$1.4 < V_r < 2.2V$
		300mA-700mA	$2.9V < V_r < 6V$
DC/DC OFF (Shutdown)	1000mA-1200mA	$2.2V < V_r < 15V$	
	300mA-700mA	$2.2V < V_r < 15V$	
Remote Pin Drive Current	$V_r = 5V$	1mA max	
Quiescent Input Current in Shutdown Mode	$V_{in} = 36V$	200µA max	
Maximum PWM Frequency	For ±1% Linear Operation	200Hz max.	
	Frequency Limit	2000Hz max.	

**Analogue Dimming Control** (leave open if not used - do not tie to +Vin)

Input Voltage Limits	Standard	-0.3V - 15V	
	Vref Version	-0.3V - 5V	
Control Voltage Range (see Graphs)	Full On	$0.13V \pm 50mV$	
	Standard: Full Off	$4.5V \pm 50mV$	
	Vref Version: Full Off	$3.3V \pm 50mV$	
	Vc=5V	0.2mA max.	
Analogue Pin Drive Current	Vc=5V	0.2mA max.	
	Vref Version	Vref Voltage	$3.3V \pm 70mV$
	Vref Output Current	5mA	
	Vref Output Short Circuit Current	18mA typ.	

**Environmental**

Relative Humidity	5% to 95% RH, non-condensing	
-------------------	------------------------------	--

/W Versions	IP67	
-------------	------	--

Conducted Emissions	(with filter, see note)	EN55022	Class B
Radiated Emissions	(all series except >700mA)	EN55022	Class B
ESD	(all series)	EN61000-4-2	Class A
Radiated Immunity	(all series)	EN61000-4-3	Class A
Fast Transient	(all series)	EN61000-4-4	Class A
Conducted Immunity	(all series)	EN61000-4-6	Class A
MTBF (RCD-24-0.70, Nominal Vin, Full Load)	+25°C	605 x 10 <sup>3</sup> hours	
	+71°C	516 x 10 <sup>3</sup> hours	

Note: Requires an input filter to meet EN55022 Class B conducted emissions - see next page

**Digital Dimming**

PWM Digital Control Signal

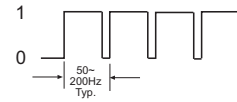

Output Current (LED appears dim)



PWM Digital Control Signal

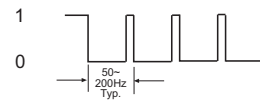

Output Current (LED appears bright)



**Analogue Dimming**

**Standard Version:**

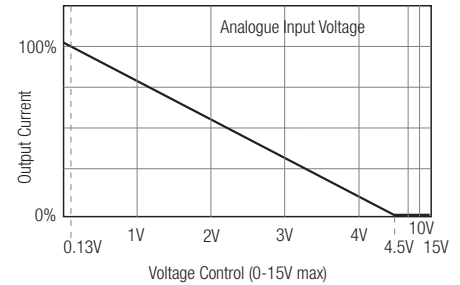

**Vref Version:**

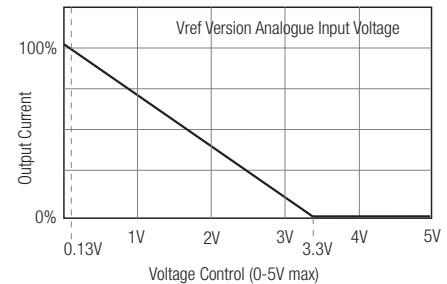

**Combined PWM and Analogue Dimming**

PWM Digital Control Signal

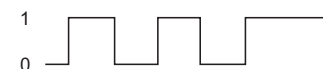

Output Current

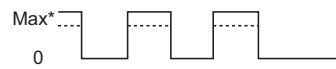

\* Max output current can also be set using Analogue input

Typical Characteristics

Efficiency/Load

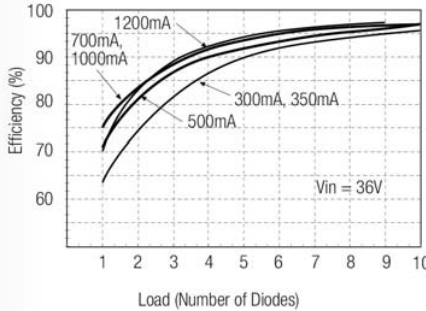

Dropout Voltage/Load

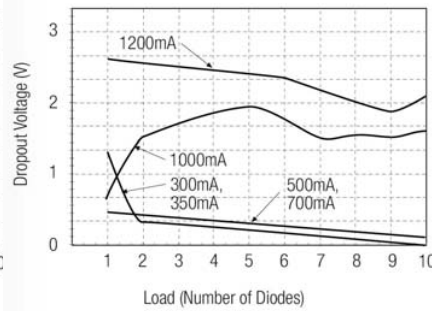

Output Current Accuracy/Load

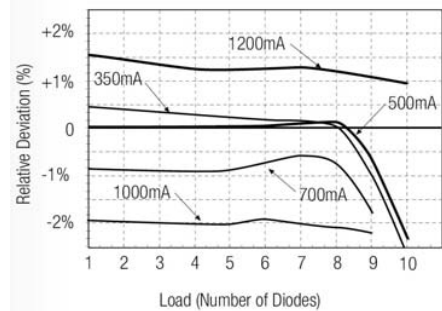

EMI Filter Suggestions

CLASS A

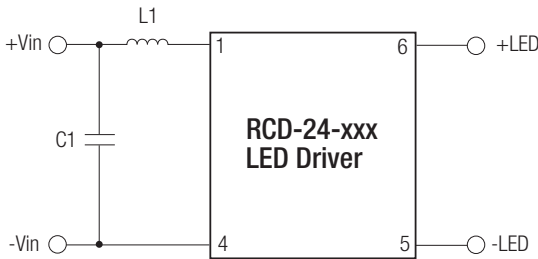

**RCD-24-0.30 - RCD-24-0.70**

C1 = 1µF MLCC

L1 = 22µH

**RCD-24-1.00 - RCD-24-1.20**

C1 = 2.2µF MLCC

L1 = 47µH

CLASS B

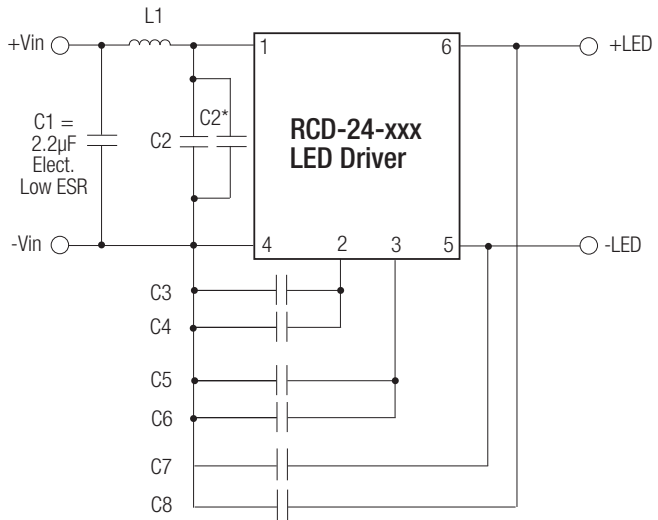

**RCD-24-0.30 - RCD-24-0.70**

No dimming or PWM dimming:

L1 = 47µH

C2 = C3 = 10nF MLCC

Other caps not required

Analogue Dimming used:

L1 = 120µH

C2 = C7 = 10nF MLCC

Other caps not required

**RCD-24-1.00 - RCD-24-1.20**

L1 = 220µH

C2 = 10nF

C3 = C5 = 2.2nF

C4 = C6 = C7 = C8 = 100nF

All capacitors MLCC

C2\* = optional 2µ2 MLCC only if L1 starts to resonate with the back ripple current.

Recommended Class B PCB Layout for Pinned / SMD Versions

Top View

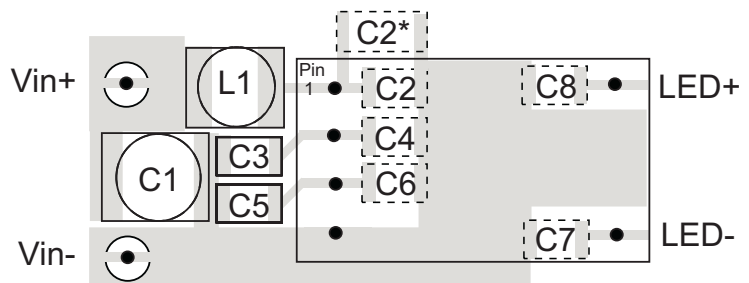

RCD-24

**Application Examples**

**Standard Application**

**LED DRIVER with 0-10V Interface**

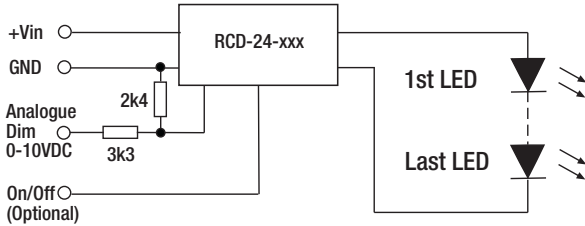

**LED DIMMER for up to 10 white LEDs**

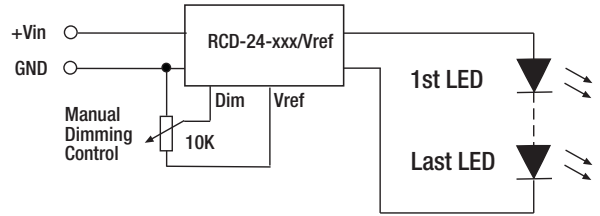

**MULTIPLE LED DRIVER (up to 20 LEDs)**

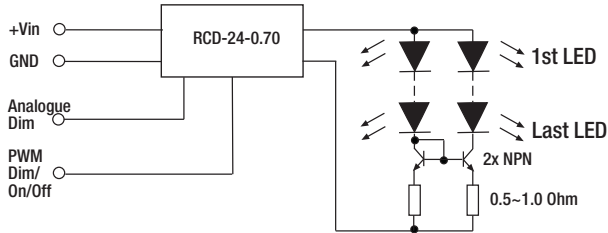

**LED DIMMER with high frequency PWM control**

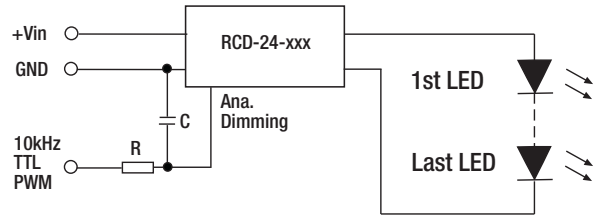

Driving Two Strings of 350mA LEDs with one 700mA Driver using a current mirror

**LED Temperature Monitoring**

**Automatic LED Overtemperature Protection**

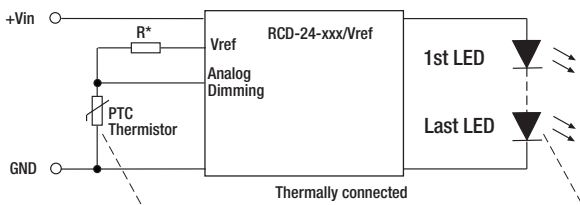

\*Typically, choose R so that  $R=R_{ptc} @ 85^{\circ}C$  and  $R>660 \text{ Ohm}$ .

**Typical Response Curve (PTC = 500 Ohm @ 70°C)**

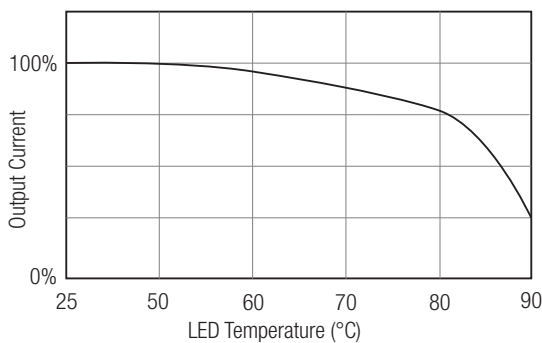

**RGB Driver**

**SIMPLE RGB Mixer**

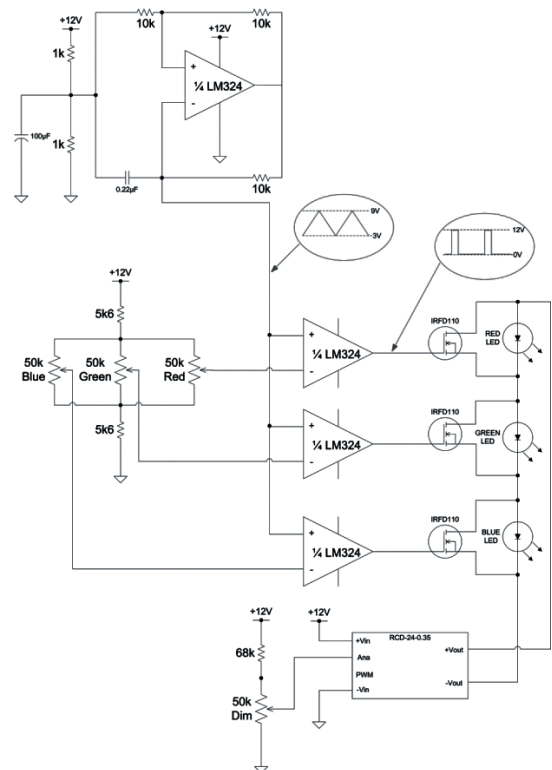

**RCD-24**

# LIGHTLINE

## DC/DC-Converter

# RCD-24 Series

### Package Style and Pinning

#### Pinned Version

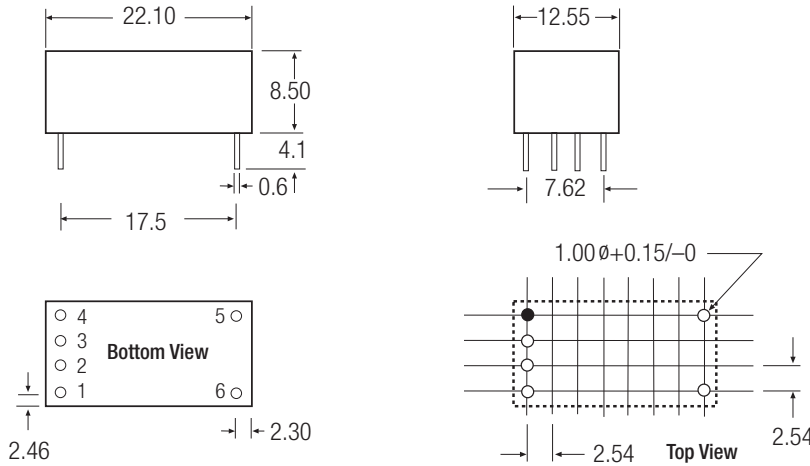

Pin #	Out	Comments
1	+Vin	DC Supply
2	Analogue Dimming	Leave open if not used
3	PWM/ON/OFF	Leave open if not used
(3)	Vref	Vref Version only
4	GND	Do not connect to -Vout
5	-Vout	LED Cathode Connection
6	+Vout	LED Anode Connection

XX.X ± 0.5 mm  
 XX.XX ± 0.25 mm  
 Pin Tolerance ± 0.1 mm

Leave >1mm space around case on PCB for air circulation

Recommended Footprint Details

#### SMD Version

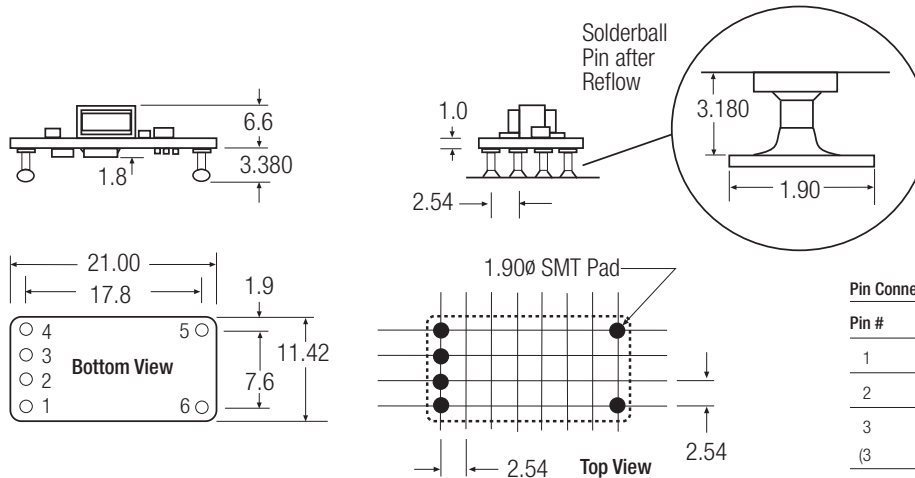

Pin #	Out	Comments
1	+Vin	DC Supply
2	Analogue Dimming	Leave open if not used
3	PWM/ON/OFF	Leave open if not used
(3)	Vref	Vref Version only
4	GND	Do not connect to -Vout
5	-Vout	LED Cathode Connection
6	+Vout	LED Anode Connection

XX.X ± 0.5 mm  
 XX.XX ± 0.25 mm  
 XX.XXX ± 0.01 mm

RCD-24

Due to the compact size of the Open Frame version, a product code label is used instead of the whole part number.

The product code consists of RCD xxxx (where xxxx is the datecode) followed by an 8 digit reference code, e.g.

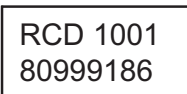

= RCD-24-0.35/SMD/OF, manufactured in Week 1 of 2010.

The reference codes for standard parts are:

- RCD-24-0.30/SMD/OF = 80999199
- RCD-24-0.35/SMD/OF = 80999186
- RCD-24-0.50/SMD/OF = 80999200
- RCD-24-0.60/SMD/OF = 80999201
- RCD-24-0.70/SMD/OF = 80999202

Other custom or semi-custom parts may have different reference codes.

Package Style and Pinning

Wired Versions

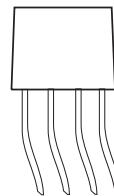
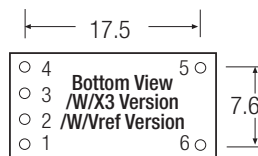
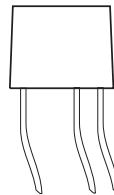
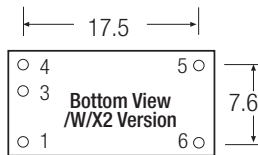
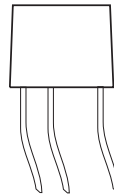
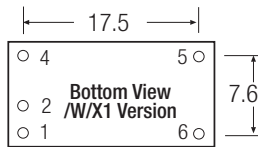
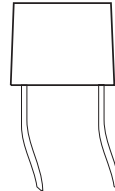
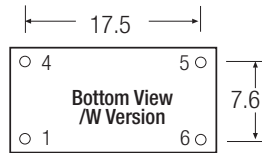

Wire Connections RCD-24/W Series

Wire #	Function	Comments
1 (Red)	+Vin	DC Supply
4 (Black)	GND	Do not connect to -Vout
5 (Brown)	-Vout	LED Cathode Connection
6 (Yellow)	+Vout	LED Anode Connection

Wire length = 100mm + 10mm stripped & tinned = 110mm total

Wire outside diameter = 1.6mm

Wire core diameter = 0.75mm

Wire is UL/CSA listed/ 22AWG / 300V Rated

Wire Connections RCD-24/W/X Series

Wire #	Function	Comments
2 (Green)	Ana Dimming	/X1
3 (Blue)	PWM Dimming	/X2
2 + 3 (Green + Blue)	Ana + PWM Dimming	/X3
2 + 3 (Green + Yellow)	Ana Dimming + Vref	/Vref

Wire length = 100mm + 10mm stripped & tinned = 110mm total

Wire outside diameter = 1.6mm

Wire core diameter = 0.75mm

Wire is UL/CSA listed/ 22AWG / 300V Rated

RCD-24

Wired Versions are packed in bags - 5pcs per bag.