

HIGH EFFICIENCY GREEN MAN8400 SERIES

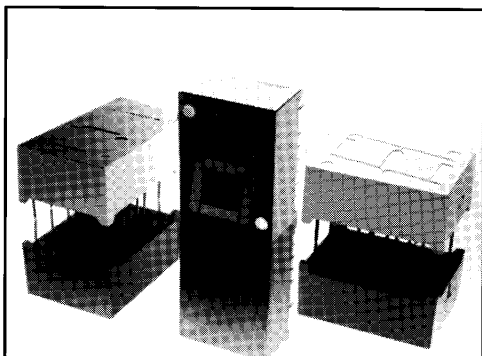

FEATURES

- High Efficiency Green nitrogen-doped GaAsP on GaP
- Large, easy to read, digits
- Common anode or common cathode models
- Fast switching — excellent for multiplexing
- Low power consumption
- Bold solid segments that are highly legible
- Solid state reliability — long operation life
- Rugged plastic construction
- Directly compatible with integrated circuits
- High brightness with high contrast
- Categorized for Luminous Intensity (See Note 5)
- Wide angle viewing...150°
- Low forward voltage
- Two-digit package simplifies alignment and assembly

DESCRIPTION

The MAN8400 Series is a family of large digits 0.8-inches in height. This series combines high brightness, large size, good aesthetics and is designed to be used where accurate readable displays need to be viewed over a distance. All models use right hand decimal points. The display ON and OFF contrast has been optimized for high ambient light conditions by use of a neutral Grey face and diffused White segments. Construction makes use of a metal leadframe, plastic reflector cap with epoxy-filled segments and back.

APPLICATIONS

- For industrial and consumer applications such as:
- Digital readout displays
 - Instrument panels
 - Point of sale equipment
 - Digital clocks
 - TV and radios

MODEL NUMBERS			
PART NUMBER	COLOR	DESCRIPTION	PACKAGE DRAWING
MAN8410	High Efficiency Green	Common Anode; Right Hand Decimal	1
MAN8440	High Efficiency Green	Common Cathode; Right Hand Decimal	1

RECOMMENDED OPTICAL FILTERS	
For optimum ON and OFF contrast, one of the following filters or equivalents should be used over the display:	
<u>DEVICE TYPE</u>	<u>FILTER</u>
MAN8400 Series	Panelgraphic Green 48 Homalite 100-1440 Green Panelgraphic Grey 10 Homalite 100-1266 Grey

ELECTRO-OPTICAL CHARACTERISTICS (Per Diode at 25°C Free Air Temperature Unless Otherwise Specified)					
	MIN.	TYP.	MAX.	UNITS	TEST CONDITIONS
Luminous Intensity, digit average (See Notes 1 and 4)	750	3200		μcd	I _f =10 mA
Pulsed Luminous Intensity, digit average	900	4000		μcd	I _f =60 mA peak 1:6 DF
Peak emission wavelength		562		nm	
Dominant wavelength		567		nm	
Spectral line half width		30		nm	
Forward voltage		2.2	3.0	V	I _f =20 mA
Dynamic resistance (See Figure 1)		12		Ω	I _f =20 mA
Light rise time		500		nsec	I _f =10 mA
Capacitance		40		pF	V=0, f=MHz
Reverse current			100	μA	V _R =3.0 V

ABSOLUTE MAXIMUM RATINGS	
Power dissipation at 25°C ambient	600 mW
Derate linearly from 50°C	-12 mW/°C
Storage and operating temperature	-40°C to +85°C
Continuous forward current	
Total	240 mA
Per segment	30 mA
Decimal point	30 mA
Reverse voltage	
Per segment	6.0 V
Decimal point	6.0 V
Soldering time at 260°C (See Notes 2 and 3)	5 sec.

TYPICAL THERMAL CHARACTERISTICS	
Thermal resistance junction to free air Φ_{JA}	160°C/W
Wavelength temperature coefficient (case temperature)	1.0Å/°C
Forward voltage temperature coefficient	-1.4 mV/°C

NOTES	
1. The digit average Luminous Intensity is obtained by summing the Luminous Intensity of each segment and dividing by the total number of segments. Intensity will not vary more than ±33.3% between all segments within a digit.	
2. Leads of the device immersed to 1/16 inch from the body. Maximum device surface temperature is 140°C.	
3. For flux removal, Freon TF, Freon TE, Isoproponal or water may be used up to their boiling points.	
4. Intensity adjusted for smaller areas of the "+" and decimal points.	
5. All displays are categorized for Luminous Intensity. The Intensity category is marked on each part as a suffix letter to the part number.	

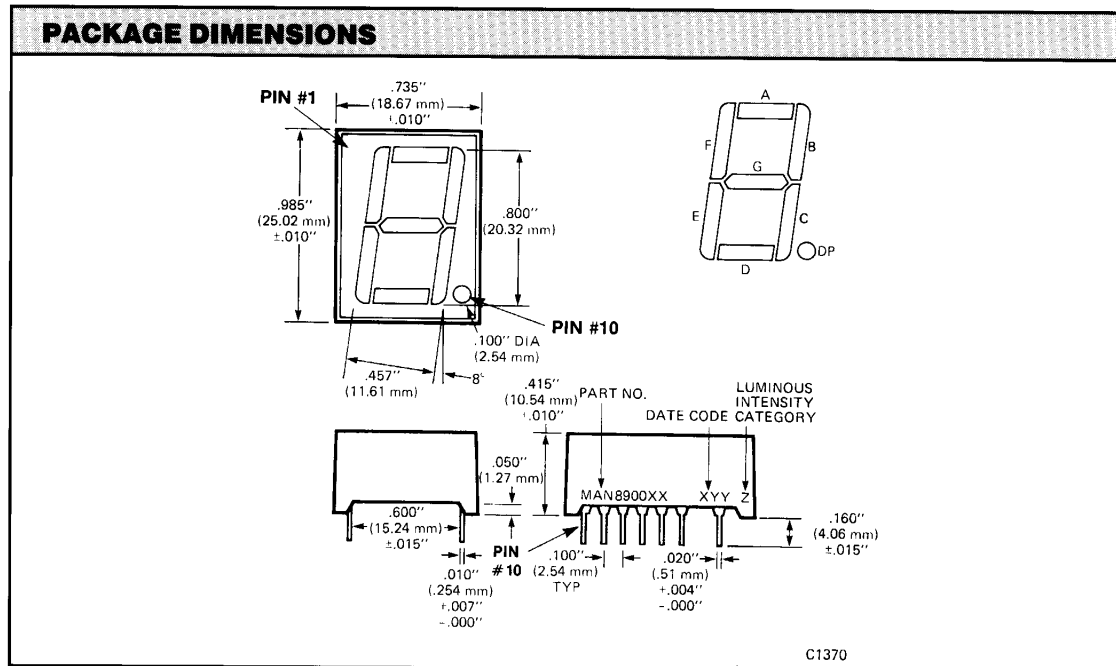

ELECTRICAL CONNECTIONS

ELECTRICAL CONNECTIONS		
	MAN8410	MAN8440
	Digit	Digit
	Common Anode	Common Cathode
PIN #	Package Dimensions	Package Dimensions
1	No Connection	No Connection
2	A Cathode	A Anode
3	F Cathode	F Anode
4	Common Anode	Common Cathode
5	E Cathode	E Anode
6	—	—
7	E Cathode	E Anode
8	—	—
9	D Cathode	—
10	DP Cathode	Common Cathode
11	D Cathode	DP Anode
12	Common Anode	D Anode
13	C Cathode	Common Cathode
14	G Cathode	C Anode
15	B Cathode	G Anode
16	—	B Anode
17	Common Anode	—
18	—	Common Anode

TYPICAL CHARACTERISTIC CURVES

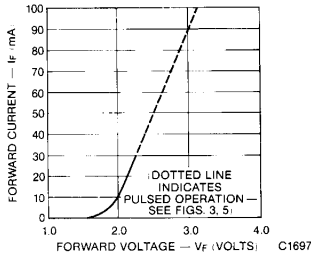

Fig. 1. Forward Current vs. Forward Voltage

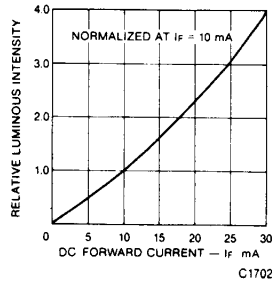

Fig. 2. Relative Luminous Intensity vs. DC Forward Current

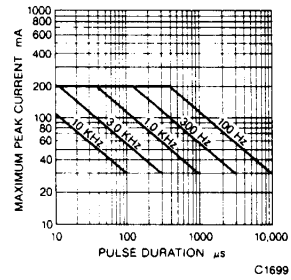

Fig. 3. Maximum Peak Current vs. Pulse Duration

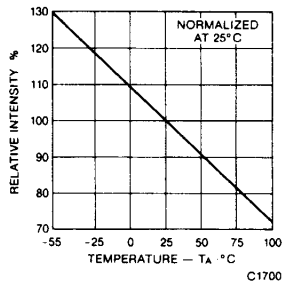

Fig. 4. Relative Luminous Intensity vs. Temperature

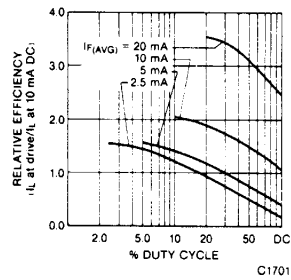
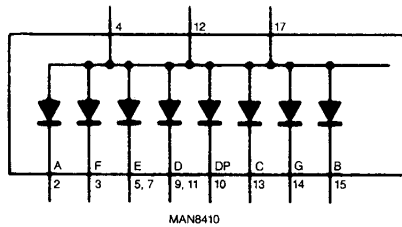
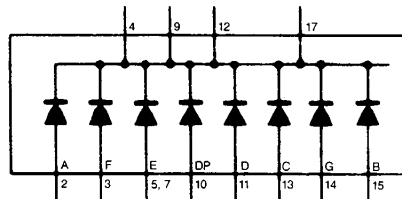

Fig. 5. Relative Efficiency vs. Duty Cycle

INTERNAL CONNECTIONS



MAN8410



MAN8440

DISCLAIMER

FAIRCHILD SEMICONDUCTOR RESERVES THE RIGHT TO MAKE CHANGES WITHOUT FURTHER NOTICE TO ANY PRODUCTS HEREIN TO IMPROVE RELIABILITY, FUNCTION OR DESIGN. FAIRCHILD DOES NOT ASSUME ANY LIABILITY ARISING OUT OF THE APPLICATION OR USE OF ANY PRODUCT OR CIRCUIT DESCRIBED HEREIN; NEITHER DOES IT CONVEY ANY LICENSE UNDER ITS PATENT RIGHTS, NOR THE RIGHTS OF OTHERS.

LIFE SUPPORT POLICY

FAIRCHILD'S PRODUCTS ARE NOT AUTHORIZED FOR USE AS CRITICAL COMPONENTS IN LIFE SUPPORT DEVICES OR SYSTEMS WITHOUT THE EXPRESS WRITTEN APPROVAL OF THE PRESIDENT OF FAIRCHILD SEMICONDUCTOR CORPORATION. As used herein:

1. Life support devices or systems are devices or systems which, (a) are intended for surgical implant into the body, or (b) support or sustain life, and (c) whose failure to perform when properly used in accordance with instructions for use provided in the labeling, can be reasonably expected to result in a significant injury of the user.
2. A critical component in any component of a life support device or system whose failure to perform can be reasonably expected to cause the failure of the life support device or system, or to affect its safety or effectiveness.