

FEATURES

- * 0.5INCH (12.7mm) DIGIT HEIGHT
- * CONTINUOUS UNIFORM SEGMENTS
- * LOW POWER REQUIREMENT
- * EXCELLENT CHARACTERS APPEARANCE
- * HIGH BRIGHTNESS & HIGH CONTRAST
- * WIDE VIEWING ANGLE
- * SOLID STATE RELIABILITY
- * CATEGORIZED FOR LUMINOUS INTENSITY

DESCRIPTION

The LTD-535R is a 0.5inch (12.7mm) digit height dual digit seven-segment display. The device utilizes red LED chips, which are made from GaAsP on a transparent GaAs substrate, and has a black face and white segments.

DEVICE

PART NO.	DESCRIPTION
RED	COMMON CATHODE
LTD-535R	RT. HAND DECIMAL

PACKAGE DIMENSIONS

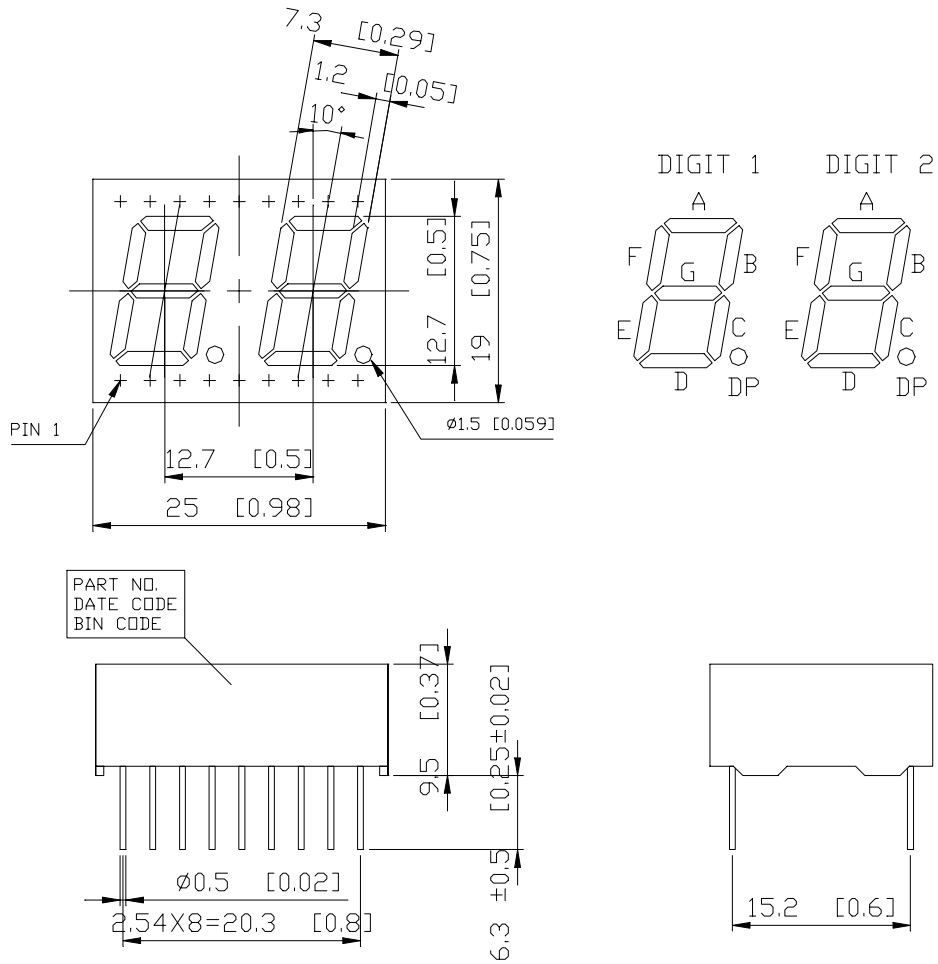

NOTES: All dimensions are in millimeters. Tolerances are ± 0.25 mm unless otherwise noted.

INTERNAL CIRCUIT DIAGRAM

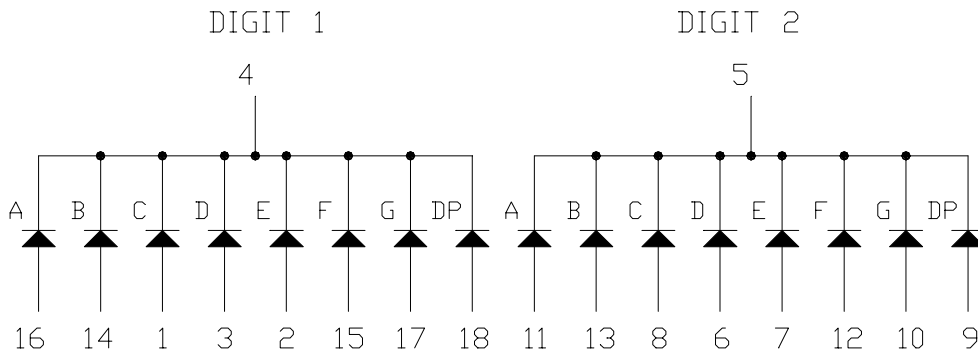

PIN CONNECTION

No.	CONNECTION
1	ANODE C (DIGIT 1)
2	ANODE E (DIGIT 1)
3	ANODE D (DIGIT 1)
4	COMMON CATHODE (DIGIT 1)
5	COMMON CATHODE (DIGIT 2)
6	ANODE D (DIGIT 2)
7	ANODE E (DIGIT 2)
8	ANODE C (DIGIT 2)
9	ANODE DP (DIGIT 2)
10	ANODE G (DIGIT 2)
11	ANODE A (DIGIT 2)
12	ANODE F (DIGIT 2)
13	ANODE B (DIGIT 2)
14	ANODE B (DIGIT 1)
15	ANODE F (DIGIT 1)
16	ANODE A (DIGIT 1)
17	ANODE G (DIGIT 1)
18	ANODE DP (DIGIT 1)

ABSOLUTE MAXIMUM RATING AT T_A=25°C

PARAMETER	MAXIMUM RATING	UNIT
Power Dissipation Per Chip	55	mW
Peak Forward Current Per Chip (1/10 Duty Cycle, 0.1ms Pulse Width)	150	mA
Continuous Forward Current Per Chip	25	mA
Derating Linear From 25°C Per Chip	0.33	mA/°C
Reverse Voltage Per Chip	5	V
Operating Temperature Range	-35°C to +85°C	
Storage Temperature Range	-35°C to +85°C	
Solder Temperature: max 260°C for max 3sec at 1.6mm below seating plane		

TRICAL / OPTICAL CHARACTERISTICS AT T_A=25°C

PARAMETER	SYMBOL	MIN.	TYP.	MAX.	UNIT	TEST CONDITION
Average Luminous Intensity	I _v	200	500		μcd	I _F =10mA
Peak Emission Wavelength	λ _p		655		nm	I _F =20mA
Spectral Line Half-Width	Δλ		24		nm	I _F =20mA
Dominant Wavelength	λ _d		651		nm	I _F =20mA
Forward Voltage Per Chip	V _F		1.7	2.6	V	I _F =20mA
Reverse Current Per Chip	I _R			100	μA	V _R =5V
Luminous Intensity Matching Ratio	I _v -m			2:1		I _F =10mA

Note: Luminous intensity is measured with a light sensor and filter combination that approximates the CIE (Commision Internationale De L'Eclairage) eye-response curve.

TYPICAL ELECTRICAL / OPTICAL CHARACTERISTIC CURVES

(25°C Ambient Temperature Unless Otherwise Noted)

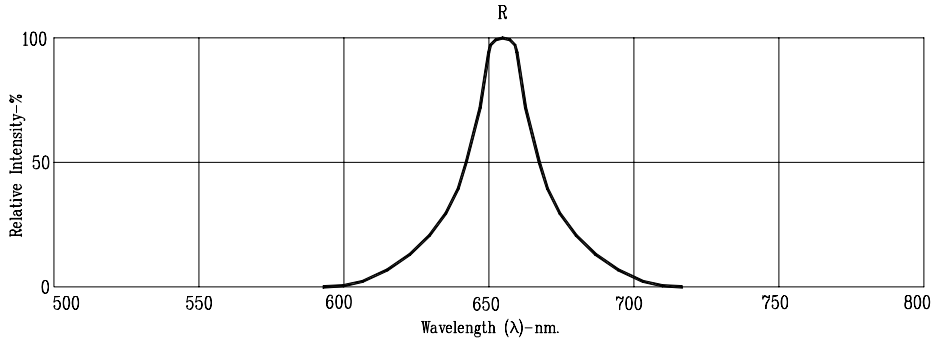

Fig1. RELATIVE INTENSITY VS. WAVELENGTH

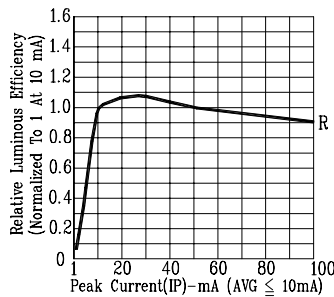

Fig2. RELATIVE LUMINOUS EFFICIENCY (LUMINOUS INTENSITY PER UNIT CURRENT) VS. PEAK CURRENT (REFRESH RATE 1KHz)

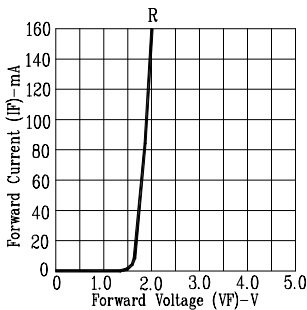

Fig3. FORWARD CURRENT VS. FORWARD VOLTAGE

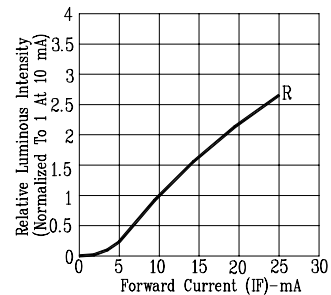

Fig4. RELATIVE LUMINOUS INTENSITY VS. FORWARD CURRENT

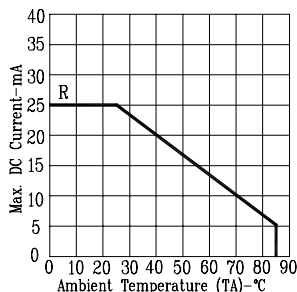

Fig5. MAX. ALLOWABLE DC CURRENT VS. AMBIENT TEMPERATURE.

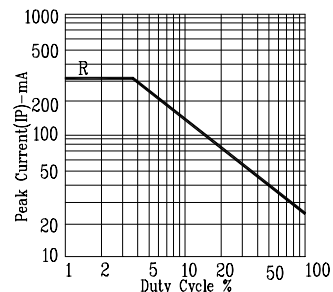

Fig6. MAX. PEAK CURRENT VS. DUTY CYCLE % (REFRESH RATE 1KHz)

NOTE: R=RED