

# LITEON

## 0.56" Seven-Segment Numeric LED Display

LTS-5x01A/5x03A

LTD-5x21A/5x23A Series

LTC-5653x-01/5753x-01

### Features

- 0.56 inch (14.22mm) digit height
- Continuous uniform segments.
- Low power requirement.
- Excellent characters appearance.
- High brightness & high contrast.
- Wide viewing angle.
- Solid state reliability.
- Categorized for luminous intensity.
- I.C. compatible.
- Easy mounting on P.C. board or socket.

### Description

The LTS-5000A/LTD-5000A/LTC-5x53x-01 is a 0.56 inch (14.22mm) height 7-Segment single, dual and quadruple displays. AlGaAs red displays have gray face and white segments. The LTS-5000A/LTD-5000A bright red, yellow and red orange displays have gray face and white segments, and green displays have gray face and green segments. The LTC-5x53x-01 displays have gray face and white segments.

The AlGaAs red 7-segment displays are designed for applications requiring low power consumption. They are tested and selected for the excellent low current characteristics to ensure that the segments are matched at low current. Drive current as low as 1 mA per segment is available.

The AlGaAs red series devices utilize LED chips which are made from AlGaAs on a non-transparent GaAs substrate. The bright red and green series devices utilize LED chips which are made from GaP on a transparent GaP substrate. The yellow and red orange series devices utilize LED chips which are made from GaAsP on a transparent GaP substrate.

### Package Dimensions

A. LTS-5X01A/5X03A

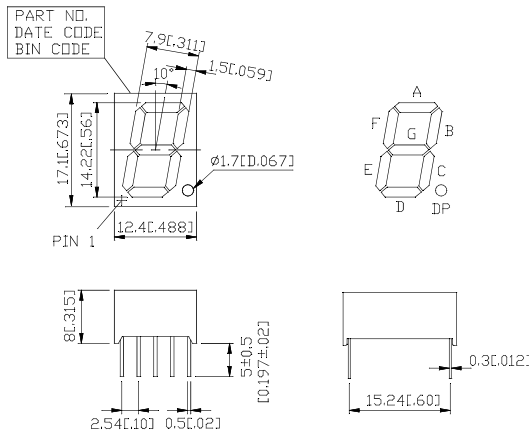

B. LTD-5X21A/5X23A

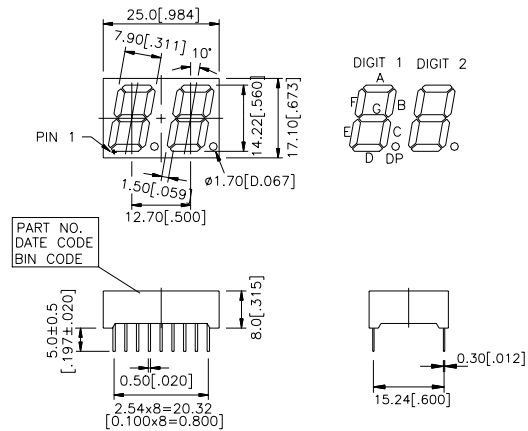

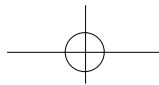

C.LTC-5653/5753

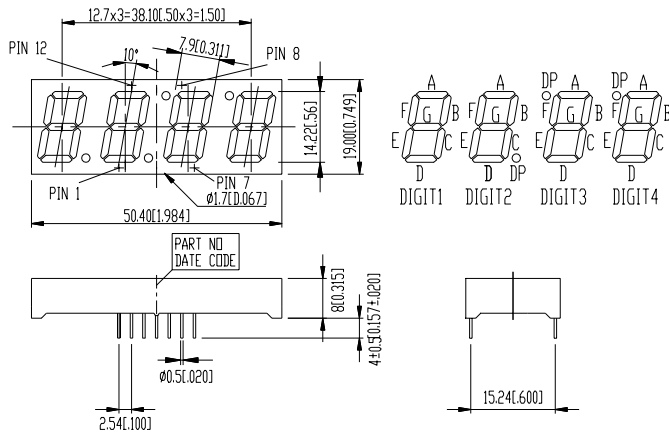

Notes: All dimensions are in millimeters (inches).

Tolerance: ± 0.25mm (0.01") unless otherwise noted.

**DISPLAYS**

**Devices**

| Part No.    |            |        |        |            | Description                      | Package Dimension | Internal Circuit Diagram |
|-------------|------------|--------|--------|------------|----------------------------------|-------------------|--------------------------|
| AlGaAs Red  | Bright Red | Green  | Yellow | Red Orange |                                  |                   |                          |
| LTS-5001AWC | 5301AP     | 5601AG | 5701AY | 5501AE     | Common Anode, Rt. Hand Decimal   | A                 | A                        |
| LTS-5003AWC | 5303AP     | 5603AG | 5703AY | 5503AE     | Common Cathode, Rt. Hand Decimal | A                 | B                        |
| LTD-5021AWC | 5321AP     | 5621AG | 5721AY | 5521AE     | Common Anode, Rt. Hand Decimal   | B                 | C                        |
| LTD-5023AWC | 5323AP     | 5623AG | 5723AY | 5523AE     | Common Cathode, Rt. Hand Decimal | B                 | D                        |

| Part No. LTC- |            |          |          |            | Description              | Package Dimension | Internal Circuit Diagram |
|---------------|------------|----------|----------|------------|--------------------------|-------------------|--------------------------|
| AlGaAs Red    | Bright Red | Green    | Yellow   | Red Orange |                          |                   |                          |
| LTC-5653WC-01 | 5653P-01   | 5653G-01 | 5653Y-01 | 5653E-01   | Common Anode Multiplex   | C                 | E                        |
| LTC-5753WC-01 | 5753P-01   | 5753G-01 | 5753Y-01 | 5753E-01   | Common Cathode Multiplex | C                 | F                        |

**Pin Connection**

| Pin No. | Connection      |                   |                         |                          |
|---------|-----------------|-------------------|-------------------------|--------------------------|
|         | A.LTS-5X01A     | B.LTS-5X03A       | C.LTD-5X21A             | D.LTD-5X23A              |
| 1.      | Cathode E       | Anode E           | Cathode E (Digit 1)     | Anode E (Digit 1)        |
| 2.      | Cathode D       | Anode D           | Cathode D (Digit 1)     | Anode D (Digit 1)        |
| 3.      | Common Anode *1 | Common Cathode *1 | Cathode C (Digit 1)     | Anode C (Digit 1)        |
| 4.      | Cathode C       | Anode C           | Cathode D.P. (Digit 1)  | Anode D.P. (Digit 1)     |
| 5.      | Cathode D.P.    | Anode D.P.        | Cathode E (Digit 2)     | Anode E (Digit 2)        |
| 6.      | Cathode B       | Anode B           | Cathode D (Digit 2)     | Anode D (Digit 2)        |
| 7.      | Cathode A       | Anode A           | Cathode G (Digit 2)     | Anode G (Digit 2)        |
| 8.      | Common Anode *1 | Common Cathode *1 | Cathode C (Digit 2)     | Anode C (Digit 2)        |
| 9.      | Cathode F       | Anode F           | Cathode D.P. (Digit 2)  | Anode D.P. (Digit 2)     |
| 10.     | Cathode G       | Anode G           | Cathode B (Digit 2)     | Anode B (Digit 2)        |
| 11.     | -               | -                 | Cathode A (Digit 2)     | Anode A (Digit 2)        |
| 12.     | -               | -                 | Cathode F (Digit 2)     | Anode F (Digit 2)        |
| 13.     | -               | -                 | Cathode Anode (Digit 2) | Common Cathode (Digit 2) |
| 14.     | -               | -                 | Cathode Anode (Digit 1) | Common Cathode (Digit 1) |
| 15.     | -               | -                 | Cathode B (Digit 1)     | Anode B (Digit 1)        |
| 16.     | -               | -                 | Cathode A (Digit 1)     | Anode A (Digit 1)        |
| 17.     | -               | -                 | Cathode G (Digit 1)     | Anode G (Digit 1)        |
| 18.     | -               | -                 | Cathode F (Digit 1)     | Anode F (Digit 1)        |

9-153

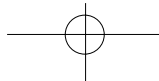

| Pin No. | Connection             |                          |
|---------|------------------------|--------------------------|
|         | E.LTC-5653X-01         | F.LTC-5753X-01           |
| 1.      | Cathode E              | Anode E                  |
| 2.      | Cathode D              | Anode D                  |
| 3.      | Cathode D.P.           | Anode D.P.               |
| 4.      | Cathode C              | Anode C                  |
| 5.      | Cathode G              | Anode G                  |
| 6.      | Common Anode (Digit 4) | Common Cathode (Digit 4) |
| 7.      | Cathode B              | Anode B                  |
| 8.      | Common Anode (Digit 3) | Common Cathode (Digit 3) |
| 9.      | Common Anode (Digit 2) | Common Cathode (Digit 2) |
| 10.     | Cathode F              | Anode F                  |
| 11.     | Cathode A              | Anode A                  |
| 12.     | Common Anode (Digit 1) | Common Cathode (Digit 1) |

## Internal Circuit Diagrams

A.LTS-5X01A

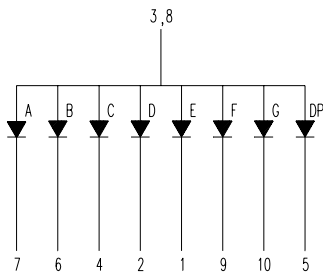

B.LTS-5X03A

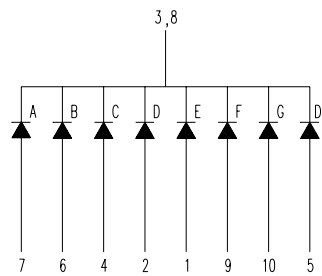

C.LTD-5X21A

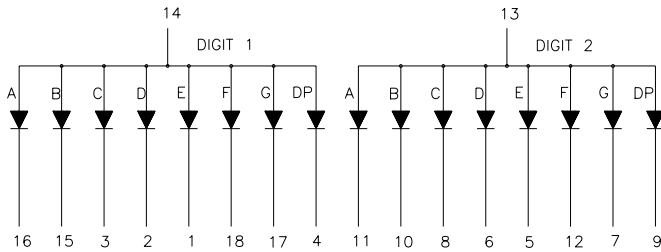

D.LTD-5X23A

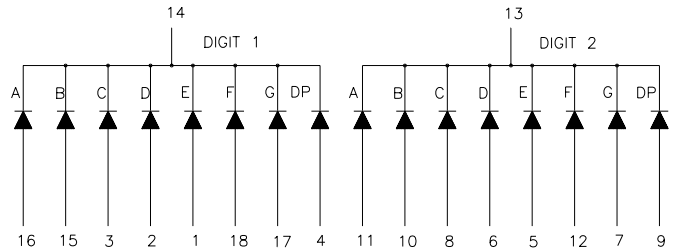

E.LTC-5653X-01

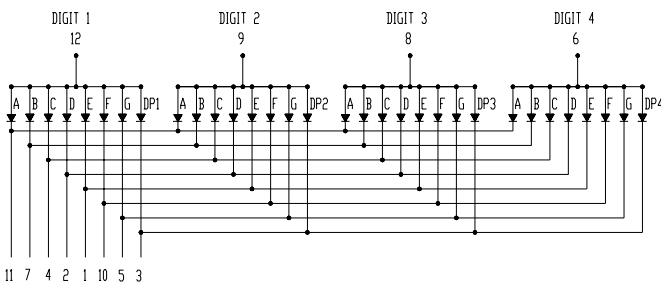

F.LTC-5753X-01

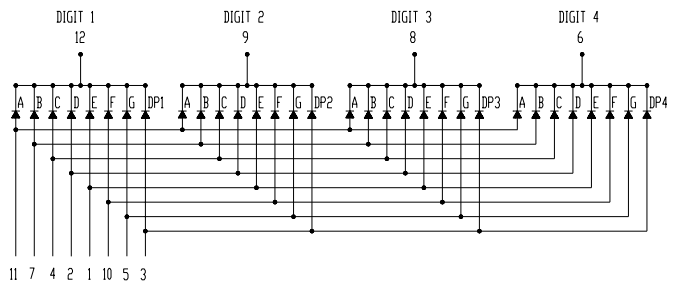

## Absolute Maximum Rating at Ta=25°C

| Parameter   | AlGaAs Red     | Bright Red | Green | Yellow | Red Orange | Unit |
|---|----------------|------------|-------|--------|------------|------|
| Power Dissipation Per Segment   | 75             | 40         | 75    | 60     | 75         | mW   |
| Peak Forward Current Per Segment<br>(1/10 Duty Cycle, 0.1ms Pulse Width)        | 125            | 60         | 100   | 80     | 100        | mA   |
| Continuous Forward Current Per Segment<br>Derating Linear from 25°C Per Segment | 30             | 15         | 25    | 20     | 25         | mA   |
| Reverse Voltage Per Segment   | 5              | 5          | 5     | 5      | 5          | V    |
| Operating Temperature Range   | -35°C to +85°C |            |       |        |            |      |
| Storage Temperature Range   | -35°C to +85°C |            |       |        |            |      |
| Solder Temperature 1/16 Inch Below Seating Plane for 3 Seconds at 260°C         |                |            |       |        |            |      |

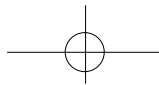

**DISPLAYS**

**Electrical/Optical Characteristics at Ta=25°C**

LTS-5001AWC/5003AWC/LTD-5021AWC/5023AWC/LTC-5653AWC/5753AWC

| Parameter                         | Symbol | Min. | Typ. | Max. | Unit | Tset Condition |
|-----------------------------------|--------|------|------|------|------|----------------|
| Average Luminous Intensity        | Iv     | 320  | 700  |      | μ cd | IF=1mA         |
|                                   |        |      | 3750 |      |      | IF=5mA         |
| Peak Emission Wavelength          | λ P    |      | 660  |      | nm   | IF=20mA        |
| Spectral Line Half-Width          | Δ λ    |      | 35   |      | nm   | IF=20mA        |
| Dominant Wavelength               | λ d    |      | 638  |      | nm   | IF=20mA        |
| Forward Voltage, Per Segment      | VF     |      | 1.6  | 2.4  | V    | IF=1mA         |
|                                   |        |      | 1.7  |      |      | IF=5mA         |
|                                   |        |      | 1.8  |      |      | IF=20mA        |
| Reverse Current, Per Segment      | IR     |      |      | 100  | μ A  | VR=5V          |
| Luminous Intensity Matching Ratio | Iv-m   |      |      | 2:1  |      | IF=1mA         |

LTS-5301AP/5303AP/LTD-5321AP/5323AP/LTC-5653P-01/5753P-01

| Parameter                            | Symbol | Min. | Typ. | Max. | Unit | Tset Condition |
|--------------------------------------|--------|------|------|------|------|----------------|
| Average Luminous Intensity           | Iv     | 320  | 950  |      | μ cd | IF=10mA        |
| Peak Emission Wavelength             | λ P    |      | 697  |      | nm   | IF=20mA        |
| Spectral Line Half-Width             | Δ λ    |      | 90   |      | nm   | IF=20mA        |
| Dominant Wavelength                  | λ d    |      | 657  |      | nm   | IF=20mA        |
| Forward Voltage, Per Segment or D.P. | VF     |      | 2.1  | 2.6  | V    | IF=20mA        |
| Reverse Current, Per Segment or D.P. | IR     |      |      | 100  | μ A  | VR=5V          |
| Luminous Intensity Matching Ratio    | Iv-m   |      |      | 2:1  |      | IF=10mA        |

LTS-5601AG/5603AG/LTD-5621AG/5623AG/LTC-5653G-01/5753G-01

| Parameter                            | Symbol | Min. | Typ. | Max. | Unit | Tset Condition |
|--------------------------------------|--------|------|------|------|------|----------------|
| Average Luminous Intensity           | Iv     | 800  | 2400 |      | μ cd | IF=10mA        |
| Peak Emission Wavelength             | λ P    |      | 565  |      | nm   | IF=20mA        |
| Spectral Line Half-Width             | Δ λ    |      | 30   |      | nm   | IF=20mA        |
| Dominant Wavelength                  | λ d    |      | 569  |      | nm   | IF=20mA        |
| Forward Voltage, Per Segment or D.P. | VF     |      | 2.1  | 2.6  | V    | IF=20mA        |
| Reverse Current, Per Segment or D.P. | IR     |      |      | 100  | μ A  | VR=5V          |
| Luminous Intensity Matching Ratio    | Iv-m   |      |      | 2:1  |      | IF=10mA        |

LTS-5501AE/5503AE/LTD-5521AE/5523AE/LTC-5653E-01/5753E-01

| Parameter                            | Symbol | Min. | Typ. | Max. | Unit | Tset Condition |
|--------------------------------------|--------|------|------|------|------|----------------|
| Average Luminous Intensity           | Iv     | 800  | 2400 |      | μ cd | IF=10mA        |
| Peak Emission Wavelength             | λ P    |      | 630  |      | nm   | IF=20mA        |
| Spectral Line Half-Width             | Δ λ    |      | 40   |      | nm   | IF=20mA        |
| Dominant Wavelength                  | λ d    |      | 621  |      | nm   | IF=20mA        |
| Forward Voltage, Per Segment or D.P. | VF     |      | 2.0  | 2.6  | V    | IF=20mA        |
| Reverse Current, Per Segment or D.P. | IR     |      |      | 100  | μ A  | VR=5V          |
| Luminous Intensity Matching Ratio    | Iv-m   |      |      | 2:1  |      | IF=10mA        |

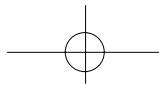

LTS-5701AY/5703AY/LTD-5721AY/5723AY/LTC-5653Y-01/5753Y-01

| Parameter                            | Symbol          | Min. | Typ. | Max. | Unit     | Tset Condition    |
|--------------------------------------|-----------------|------|------|------|----------|-------------------|
| Average Luminous Intensity           | $I_v$           | 800  | 2400 |      | $\mu$ cd | $I_F=10\text{mA}$ |
| Peak Emission Wavelength             | $\lambda_P$     |      | 585  |      | nm       | $I_F=20\text{mA}$ |
| Spectral Line Half-Width             | $\Delta\lambda$ |      | 35   |      | nm       | $I_F=20\text{mA}$ |
| Dominant Wavelength                  | $\lambda_d$     |      | 588  |      | nm       | $I_F=20\text{mA}$ |
| Forward Voltage, Per Segment or D.P. | $V_F$           |      | 2.1  | 2.6  | V        | $I_F=20\text{mA}$ |
| Reverse Current, Per Segment or D.P. | $I_R$           |      |      | 100  | $\mu$ A  | $V_R=5\text{V}$   |
| Luminous Intensity Matching Ratio    | $I_v\text{-m}$  |      |      | 2:1  |          | $I_F=10\text{mA}$ |

Note: Luminous intensity is measured with a light sensor and filter combination that approximates the CIE (Commision Internationale De L'Eclairage)eye-response curve.

### Typical Electrical/Optical Characteristic Curves (25°C Ambient Temperature Unless Otherwise Noted)

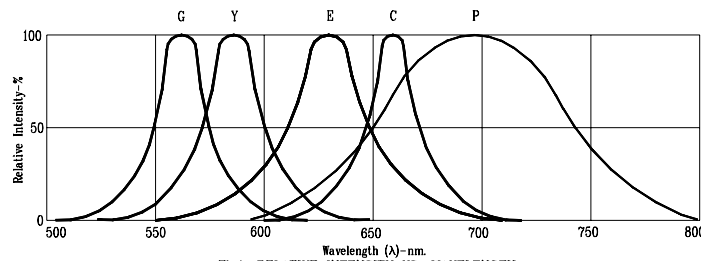

Fig1. RELATIVE INTENSITY VS. WAVELENGTH

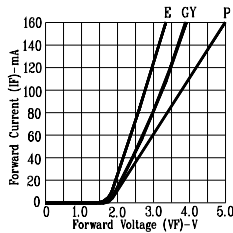

Fig2. FORWARD CURRENT VS. FORWARD VOLTAGE

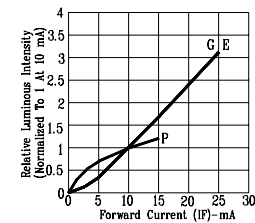

Fig3. RELATIVE LUMINOUS INTENSITY VS. FORWARD CURRENT

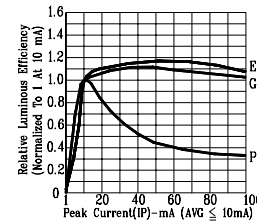

Fig4. RELATIVE LUMINOUS EFFICIENCY (LUMINOUS INTENSITY PER UNIT CURRENT) VS. PEAK CURRENT

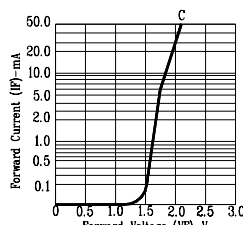

Fig5. FORWARD CURRENT VS. FORWARD VOLTAGE

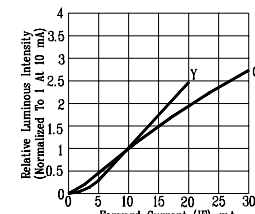

Fig6. RELATIVE LUMINOUS INTENSITY VS. FORWARD CURRENT

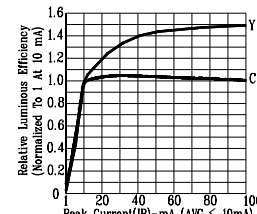

Fig7. RELATIVE LUMINOUS EFFICIENCY (LUMINOUS INTENSITY PER UNIT CURRENT) VS. PEAK CURRENT

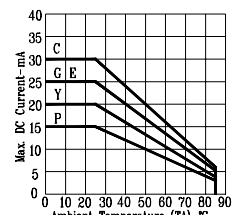

Fig8. MAX. ALLOWABLE DC CURRENT VS. AMBIENT TEMPERATURE.

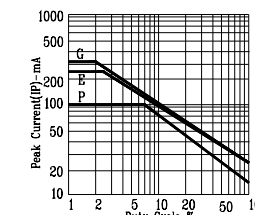

Fig9. MAX. PEAK CURRENT VS. DUTY CYCLE % (REFRESH RATE 1KHz)

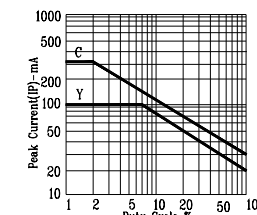

Fig10. MAX. PEAK CURRENT VS. DUTY CYCLE % (REFRESH RATE 1KHz)

9-156

NOTE: P=BRIGHT RED E=RED ORANGE G=GREEN Y=YELLOW C=AlGaAs RED (REFRESH RATE 1KHz)