

LITEON

0.36" Single Digit Numeric LED Displays LTS-360 Series

Features

- 0.36 inch (9.14mm) digit height
- Continuous uniform segments.
- Choices of six bright colors- AlGaAs red/bright red/green/yellow/red orange/high efficiency red.
- Low power requirement.
- Excellent characters appearance.
- High brightness.
- Wide viewing angle.
- Solid state reliability.
- Categorized for luminous intensity.
- I.C. compatible.
- Easy mounting on P.C. board.

Descriptions

The LTS-360 series are 0.36 inch (9.14mm) height single digit displays. AlGaAs red displays has gray face and white segments. Bright red and high efficiency red displays have red face and red segments. Green, yellow AlGaAs red and red orange displays have gray face and white segments.

The AlGaAs red seven segment displays are designed for applications requiring low power consumption. They are tested and selected for their excellent low current characteristics to ensure that the segments are matched at low current. Drive current as low as 1 mA per segment is available.

The AlGaAs red series devices utilize LED chips which are made from AlGaAs on a non-transparent GaAs substrate. The bright red and green series devices utilize LED chips which are made from GaP on a transparent GaP substrate. The yellow and red orange series devices utilize LED chips which are made from GaAsP on a transparent GaP substrate.

Package Dimensions

A.LTS-360/367

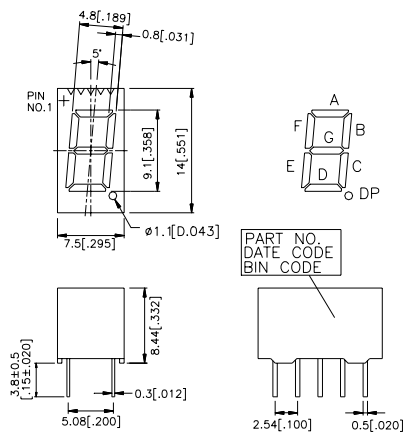

B.LTS-368

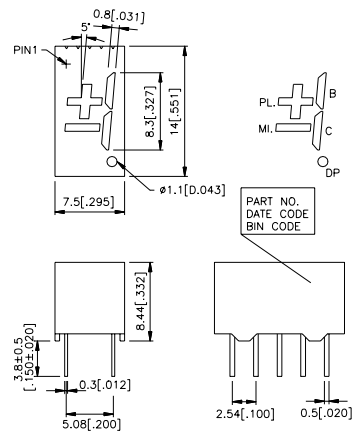

Notes: All dimensions are in millimeters (inches). Tolerance: $\pm 0.25\text{mm}$ (0.01") unless otherwise noted.

Devices

Part No. LTS-						Description	Package Dimension	Internal Circuit Diagram
AlGaAs Red	Bright Red	Green	Yellow	Red Orange	Hi.-EFF. Red			
360WC	360P	360G	360Y	360E	360HR	Common Anode, Rt. Hand Decimal	A	A
367WC	367P	367G	367Y	367E	367HR	Common Cathode, Rt. Hand Decimal	A	B
368WC	368P	368G	368Y	368E	368HR	Common Cathode, ± 1 Overflow	B	C

Pin Connection

Pin No.	Connection		
	A.LTS-360	B.LTS-367	C.LTS-368
1.	Common Anode *1	Common Cathode *1	Cathode PL & Mi. *2
2.	Cathode F	Anode F	Anode Plus Sign
3.	Cathode G	Anode G	Anode Minus Sign
4.	Cathode E	Anode E	Cathode PL & Mi. *2
5.	Cathode D	Anode D	No Pin
6.	Common Anode *1	Common Cathode *1	Cathode B, C & D.P. *3
7.	Cathode D.P.	Anode D.P.	Anode D.P.
8.	Cathode C	Anode C	Anode C
9.	Cathode B	Anode B	Anode B
10.	Cathode A	Anode A	Cathode B, C & D.P. *3

Note: 1. Pin 1 & 6 are internally connected. 2. Pin 1 & 4 are internally connected. 3. Pin 6 & 10 are internally connected.

Internal Circuit Diagrams

A.LTS-360

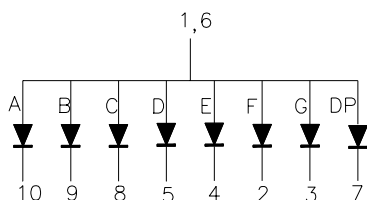

B.LTS-367

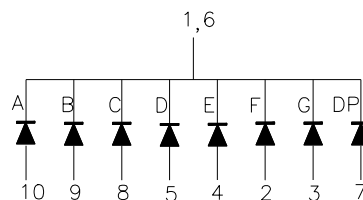

C.LTS-368

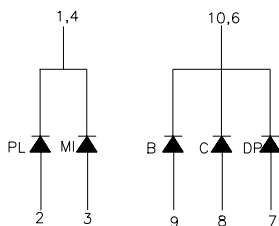

Absolute Maximum Rating at Ta=25°C

Parameter	AlGaAs Red	Bright Red	Green	Yellow	Red Orange	Hi. -Eff. Red	Unit
Power Dissipation Per Segment	75	40	75	60	75	75	mW
Peak Forward Current Per Segment (1/10 Duty Cycle, 0.1ms Pulse Width)	125	60	100	80	100	100	mA
Continuous Forward Current Per Segment	30	15	25	20	25	25	mA
Derating Linear from 25°C Per Segment	0.4	0.2	0.33	0.27	0.33	0.33	mA/°C
Reverse Voltage Per Segment	5	5	5	5	5	5	V
Operating Temperature Range	-35°C to +85°C						
Storage Temperature Range	-35°C to +85°C						
Solder Temperature 1/16 Inch Below Seating Plane for 3 Seconds at 260°C							

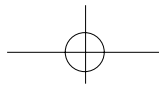

Electrical/Optical Characteristics at Ta=25°C

LTS-360WC/367WC/368WC

Parameter	Symbol	Min.	Typ.	Max.	Unit	Tset Condition
Average Luminous Intensity	I _v	200	650		μ cd	I _F =1mA
			3400			I _F =5mA
Peak Emission Wavelength	λ _P		660		nm	I _F =20mA
Spectral Line Half-Width	Δλ		35		nm	I _F =20mA
Dominant Wavelength	λ _d		638		nm	I _F =20mA
Forward Voltage, Per Segment	V _F		1.6	2.4	V	I _F =1mA
			1.7			I _F =5mA
			1.8			I _F =20mA
Reverse Current, Per Segment	I _R			100	μ A	V _R =5V
Luminous Intensity Matching Ratio	I _v -m			2:1		I _F =1mA

LTS-360P

Parameter	Symbol	Min.	Typ.	Max.	Unit	Tset Condition
Average Luminous Intensity	I _v	320	750		μ cd	I _F =10mA
Peak Emission Wavelength	λ _P		697		nm	I _F =20mA
Spectral Line Half-Width	Δλ		90		nm	I _F =20mA
Dominant Wavelength	λ _d		657		nm	I _F =20mA
Forward Voltage, Per Segment or D.P.	V _F		2.1	2.6	V	I _F =20mA
Reverse Current, Per Segment or D.P.	I _R			100	μ A	V _R =5V
Luminous Intensity Matching Ratio	I _v -m			2:1		I _F =10mA

LTS-360G

Parameter	Symbol	Min.	Typ.	Max.	Unit	Tset Condition
Average Luminous Intensity	I _v	800	2000		μ cd	I _F =10mA
Peak Emission Wavelength	λ _P		565		nm	I _F =20mA
Spectral Line Half-Width	Δλ		30		nm	I _F =20mA
Dominant Wavelength	λ _d		569		nm	I _F =20mA
Forward Voltage, Per Segment or D.P.	V _F		2.1	2.6	V	I _F =20mA
Reverse Current, Per Segment or D.P.	I _R			100	μ A	V _R =5V
Luminous Intensity Matching Ratio	I _v -m			2:1		I _F =10mA

LTS-360Y

Parameter	Symbol	Min.	Typ.	Max.	Unit	Tset Condition
Average Luminous Intensity	I _v	800	2000		μ cd	I _F =10mA
Peak Emission Wavelength	λ _P		585		nm	I _F =20mA
Spectral Line Half-Width	Δλ		35		nm	I _F =20mA
Dominant Wavelength	λ _d		588		nm	I _F =20mA
Forward Voltage, Per Segment or D.P.	V _F		2.1	2.6	V	I _F =20mA
Reverse Current, Per Segment or D.P.	I _R			100	μ A	V _R =5V
Luminous Intensity Matching Ratio	I _v -m			2:1		I _F =10mA

LTS-360E

Parameter	Symbol	Min.	Typ.	Max.	Unit	Tset Condition
Average Luminous Intensity	I _v	800	2000		μ cd	I _F =10mA
Peak Emission Wavelength	λ _P		630		nm	I _F =20mA
Spectral Line Half-Width	Δλ		40		nm	I _F =20mA
Dominant Wavelength	λ _d		621		nm	I _F =20mA
Forward Voltage, Per Segment or D.P.	V _F		2.0	2.6	V	I _F =20mA
Reverse Current, Per Segment or D.P.	I _R			100	μ A	V _R =5V
Luminous Intensity Matching Ratio	I _v -m			2:1		I _F =10mA

9-130

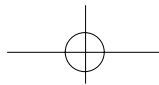

LTS-360HR

Parameter	Symbol	Min.	Typ.	Max.	Unit	Tset Condition
Average Luminous Intensity	I_v	800	2000		μ cd	$I_F=10mA$
Peak Emission Wavelength	λP		635		nm	$I_F=20mA$
Spectral Line Half-Width	$\Delta \lambda$		40		nm	$I_F=20mA$
Dominant Wavelength	λd		623		nm	$I_F=20mA$
Forward Voltage, Per Segment or D.P.	V_F		2.1	2.6	V	$I_F=20mA$
Reverse Current, Per Segment or D.P.	I_R			100	μ A	$V_R=5V$
Luminous Intensity Matching Ratio	I_v-m			2:1		$I_F=10mA$

Note: Luminous intensity is measured with a light sensor and filter combination that approximates the CIE (Commission Internationale De L'Eclairage) eye-response curve.

Typical Electrical/Optical Characteristic Curves (25°C Ambient Temperature Unless Otherwise Noted)

DISPLAYS

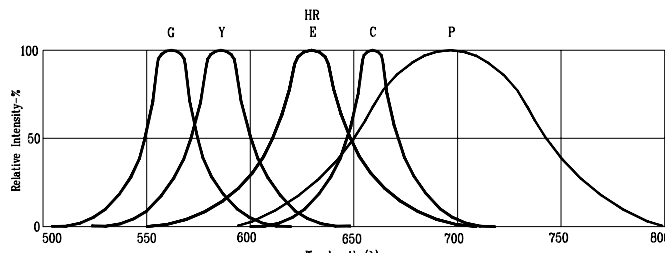

Fig1. RELATIVE INTENSITY VS. WAVELENGTH

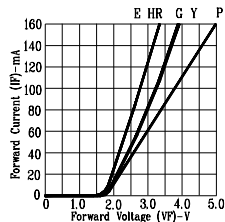

Fig2. FORWARD CURRENT VS. FORWARD VOLTAGE

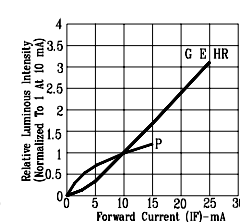

Fig3. RELATIVE LUMINOUS INTENSITY VS. FORWARD CURRENT

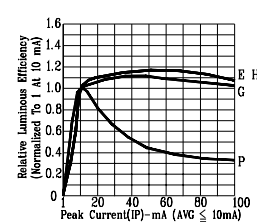

Fig4. RELATIVE LUMINOUS EFFICIENCY (LUMINOUS INTENSITY PER UNIT CURRENT) VS. PEAK CURRENT

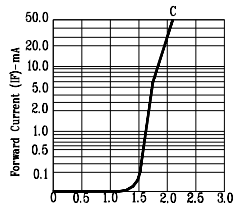

Fig5. FORWARD CURRENT VS. FORWARD VOLTAGE

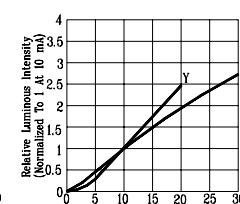

Fig6. RELATIVE LUMINOUS INTENSITY VS. FORWARD CURRENT

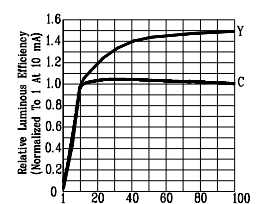

Fig7. RELATIVE LUMINOUS EFFICIENCY (LUMINOUS INTENSITY PER UNIT CURRENT) VS. PEAK CURRENT

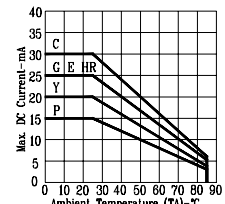

Fig8. MAX. ALLOWABLE DC CURRENT VS. AMBIENT TEMPERATURE.

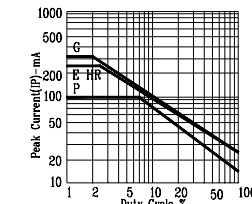

Fig9. MAX. PEAK CURRENT VS. DUTY CYCLE % (REFRESH RATE 1KHz)

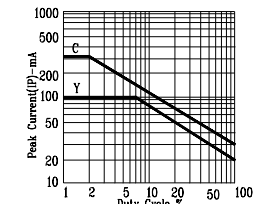

Fig10. MAX. PEAK CURRENT VS. DUTY CYCLE % (REFRESH RATE 1KHz)

NOTE: G=GREEN Y=YELLOW HR=HI-EFF. RED E=RED ORANGE C=AlGaAs RED P=BRIGHT RED (REFRESH RATE 1KHz)